

SAN FRANCISCO  
**LAW LIBRARY**

No. 28804

PRESENTED BY

---

**EXTRACT FROM BY-LAWS.**

Section 9. No book shall, at any time, be taken from the Library Room to any other place than to some court room of a Court of Record, State or Federal, in the City of San Francisco, or to the Chambers of a Judge of such Court of Record, and then only upon the accountable receipt of some person entitled to the use of the Library. Every such book so taken from the Library, shall be returned on the same day, and in default of such return the party taking the same shall be suspended from all use and privileges of the Library until the return of the book, or full compensation is made therefor to the satisfaction of the Trustees.

Sec. 11. No books shall have the leaves folded down, or be marked, dog-eared, or otherwise soiled, defaced or injured. Any party violating this provision, shall be liable to pay a sum not exceeding the value of the book, or to replace the volume by a new one, at the discretion of the Trustees or Executive Committee, and shall be liable to be suspended from all use of the Library till any order of the Trustees or Executive Committee in the premises shall be fully complied with to the satisfaction of such Trustees or Executive Committee.





Digitized by the Internet Archive  
in 2010 with funding from  
Public.Resource.Org and Law.Gov





No. 26.

---

IN THE  
United States Circuit Court of Appeals  
FOR THE NINTH CIRCUIT.

---

FRANCISCA L. DE MARTIN, *Appellant*, }  
v. }  
JAMES PHELAN, *Appellee*. }

---

TRANSCRIPT OF THE RECORD,  
UPON APPEAL FROM THE CIRCUIT COURT OF THE UNITED STATES  
FOR THE NORTHERN DISTRICT OF CALIFORNIA.

---

GEORGE D. COLLINS,  
*Attorney for Appellant.*

FRANK J. SULLIVAN, AND  
W. F. HERRIN,  
*Attorneys for Appellee.*

---

Filed February....., 1892.

.....  
*Clerk.*

---

FILED  
FEB 26 1892





Records of current  
court of appeals

4

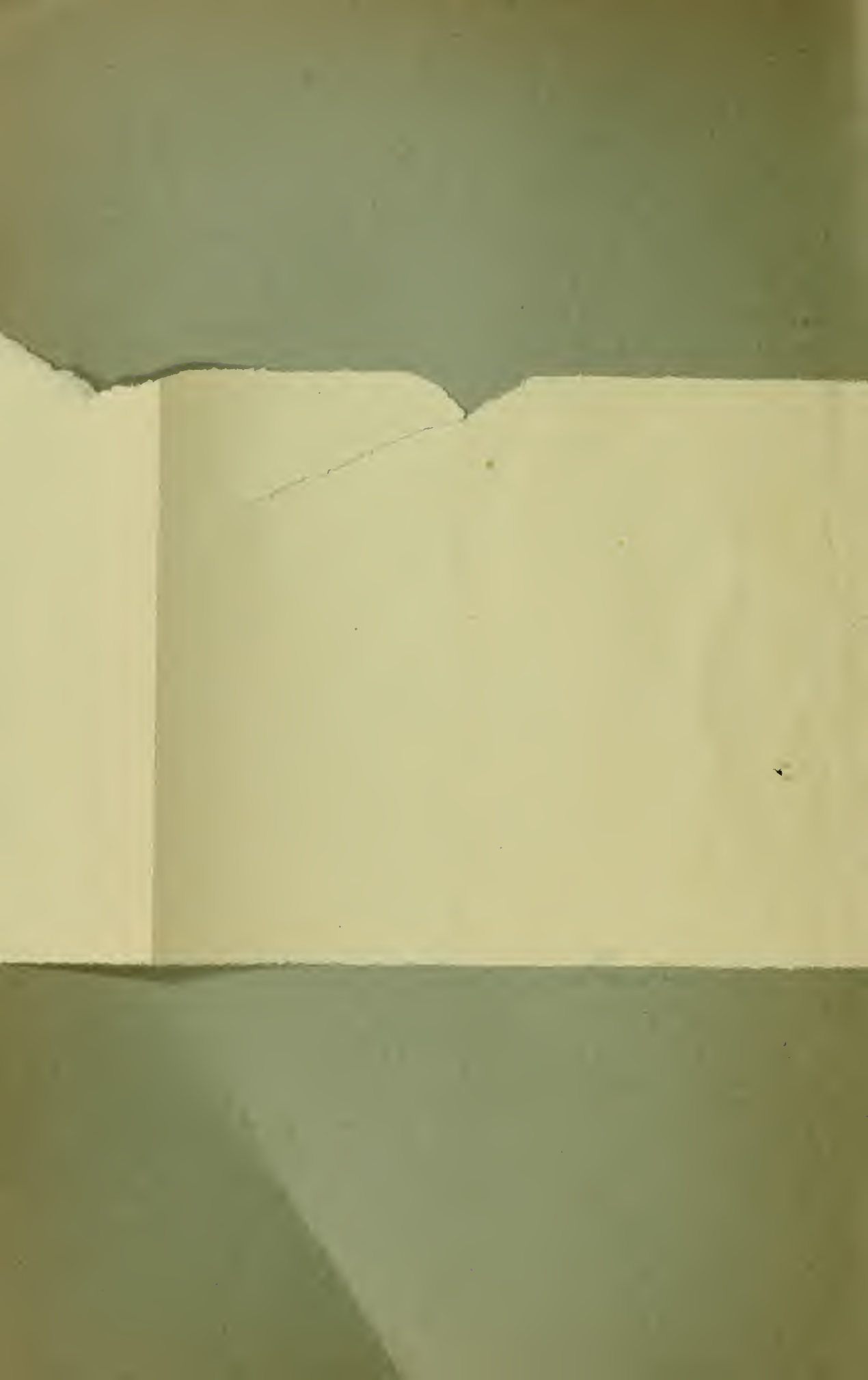

# INDEX.

---

	Page of Original Record.	Page of Printed Record.
Appeal and allowance thereof.....	20	20
Assignment of Errors.....	19	19
Bill in Equity.....	1	3
Bond on Appeal.....	22	23
Certificate to Enrollment.....	18	19
Decree.....	16	18
Demurrer.....	11	13
Enrollment.....	15	17
Order sustaining Demurrer.....	14	16
Order allowing Appeal and fixing Bond....	21	22
Subpœna <i>ad respondendum</i> .....	9	11



IN THE

# CIRCUIT COURT

OF THE

## UNITED STATES,

NINTH JUDICIAL CIRCUIT,

### NORTHERN DISTRICT OF CALIFORNIA.

---

FRANCISCA LEYBA DE MARTIN,

*Complainant,*

*v.*

JAMES PHELAN,

*Defendant.*

---

## TRANSCRIPT OF RECORD.

### BILL IN EQUITY.

*To the Judges of the Circuit Court of the United States  
for the Northern District of California :*

Francisca Leyba de Martin, of San Francisco, in the State of California, and a citizen of Mexico, brings this,

her bill, against James Phelan, of San Francisco, in the State of California, and a citizen of the State of California. And thereupon your oratrix complains and says that heretofore on the 4th day of November, 1881, she was the owner and seized in fee of all those certain pieces or parcels of land, situate, lying and being in the County of Santa Clara, in the State of California, and particularly bounded and described as follows, to wit :

Lot seven in block two, range two, north of the base line in the City of San Jose, in said County and State ; also, lot two, block one, range two, north of the base line in the City of San Jose, in said County and State ; also lots one, two, three and four in block one of range seven, north of the base line in said City of San Jose, County and State aforesaid ; also, that other tract or parcel of land lying, situate and being in said City of San Jose, bounded and described as follows, to wit :  
 Beginning on the westerly line of Second street at a point distant two hundred and seventy-five and  $\frac{68}{100}$  feet southerly from the southern line of Santa Clara street ; and from said point running southerly along the aforesaid line of Second street eighty-two and  $\frac{34}{100}$  feet ; thence westerly and parallel with Santa Clara street, one hundred and thirty-seven and  $\frac{84}{100}$  feet ; thence northerly and parallel with Second street eighty-two and  $\frac{34}{100}$  feet, thence easterly and parallel with Santa Clara street one hundred and thirty-seven and  $\frac{84}{100}$  feet to the point of beginning, and being a part of lot five in block one

range two, north of the base line. Also, that other tract or parcel of land lying, situate and being in said City of San Jose, and bounded and described as follows, to wit: Beginning on the easterly line of Market street at a point distant one hundred varas northerly from the northern line of St. John street; running thence northerly along said line of Market street twenty and  $\frac{5}{6}$  varas; thence easterly and parallel with St. John street fifty varas; thence southerly and parallel with Market street twenty and  $\frac{5}{6}$  varas; and thence westerly fifty varas to the point of beginning, and being the south part of lot four, in block three, of range one, north of the base line. Also, those other tracts or parcels of land lying, situate and being in said City of San Jose, and known and described upon the map or plat of said City as the north half ( $\frac{1}{2}$ ) of lot four and full lot five, in block two, of range one, north of the base line, and particularly bounded and described as being on the easterly line of Market street, at a point distant fifty varas southerly from the southern line of St. John street, and running thence southerly along the line of Market street twenty-five varas; thence easterly at right angles fifty varas; thence southerly at right angles twenty-five varas; thence easterly at right angles fifty varas; thence northerly at right angles fifty varas; and thence westerly at right angles one hundred varas to the place of beginning. Also, that other tract or parcel of land lying, situate and being in said City of San Jose, and bounded and de-

scribed as follows, to wit: Beginning at the intersection of the northerly line of Taylor street with the easterly line of First street; and running thence northerly and along the easterly line of First street seventeen hundred and seventy-four and  $\frac{8}{100}$  feet to the northwestern boundary line of said City; thence easterly at right angles along said boundary line thirty-one hundred and forty-one and  $\frac{12}{100}$  feet to the westerly line of Tenth street (prolonged); thence southerly at right angles along said line of Tenth street seventeen hundred and seventy-four and  $\frac{8}{100}$  feet to the northerly line of Taylor street; and thence westerly along said line of Taylor street thirty-one hundred and

4 forty-one and  $\frac{12}{100}$  feet to the point of beginning, and containing one hundred and twenty-eight acres of land. Also, that other tract or parcel of land lying, situate and being in said County of Santa Clara, and bounded and described as follows, to wit: Beginning at a stake in the east line of First street at its intersection with the northwest boundary line of the City of San Jose (proper); running thence along said boundary line north fifty-nine degrees and twenty minutes east forty-seven and  $\frac{63}{100}$  chains to the southwestern boundary of 500-acre lot 18; thence along said boundary north to thirty-eight degrees nineteen minutes west six and  $\frac{78}{100}$  chains to stake marked "No. 2," at the southeast corner of Younger's land; thence along the southeast boundary of lands of said Younger south fifty-nine degrees and twenty minutes west forty-seven and  $\frac{63}{100}$



chains to a stake marked "No. 1," on the east line of First street; and thence along said line southerly six and  $\frac{78}{100}$  chains to the place of beginning, and containing thirty-two and  $\frac{29}{100}$  acres of land. Also, that other tract or parcel of land lying, situate and being in the City of San Jose, in said County and State, and bounded and described as follows, to wit: Beginning at the intersection of the southerly line of El Dorado street with the westerly line of First street; running thence southerly along said line of First street forty-four feet; thence westerly and parallel with El Dorado street one hundred and thirty-seven and  $\frac{77}{100}$  feet; thence northerly and parallel with First street forty-four feet

5 to the southerly line of El Dorado street; and thence easterly along said line of El Dorado street one hundred and thirty-seven and  $\frac{77}{100}$  feet to the point of beginning. Also, those other tracts or parcels of land lying, situate and being in said City of San Jose, in said County and State, known and described upon the map or plat of said City as lots 6 and 7, in block 2, range 1, north of the base line. Also, that other tract or parcel of land lying, situate and being in said County of Santa Clara, and State aforesaid, and bounded and described as follows, to wit: Beginning at a stake marked "No. 1," on the northwesterly boundary line of 500-acre lot No. 9, at the intersection of the east line of the Monterey road with said boundary; and running thence along said boundary north forty-nine degrees and twenty-eight minutes

east fifty-nine and  $\frac{60}{100}$  chains to a stake marked "No. 2," on the west line of a road; then along said line of road south thirty-seven degrees and forty-nine minutes east forty-six and  $\frac{49}{100}$  chains to a stake marked "No. 3," at the corner of land now or formerly owned by Dubois; thence along the northwest boundary of said land of Dubois south fifty degrees and five minutes west fifty-nine and  $\frac{8}{100}$  chains to a stake marked "No. 4," upon the east line of Monterey road; and thence along said line of road north thirty-eight degrees and ten minutes west forty-six and  $\frac{24}{100}$  chains to the place of beginning, and containing two hundred and seventy-four and four-fifths acres of land, and being part of 500-acre lot No. 9, saving and excepting therefrom four and  $\frac{23}{100}$  acres now used and occupied by the Southern Pacific Railroad Company for its railroad.

That on said 4th day of November, 1881, and for some time prior thereto, said property was subject to mortgage liens, two of which were held by the Bank of San Jose, a corporation, and the other by one David Belden, aggregating the sum of one hundred and eighty-five thousand dollars; that the said mortgage liens held by the Bank of San Jose were foreclosed on the 13th day of August 1881, by judgment and decree of the Superior Court in and for the County of Santa Clara, in said State of California, but prior to said decree all of said mortgage liens were assigned and transferred to said defendant; that said defendant purchased said mortgage and indebtedness as a means

of securing the title to said property, and for no other purpose. That at the time of said purchase, to wit, the 13th day of August, 1881, your oratrix had no available means of support for herself and family, and was in indigent circumstances and in great need, and such continued to be her condition up to and including the 4th day of November, 1881; all of which said defendant well knew during all said time. That said defendant thereupon took advantage of the destitute condition of your oratrix, and by means of the said mortgage indebtedness purchased by him as aforesaid, induced your oratrix to transfer the said property to him in consideration of the sum of nineteen thousand  
7 dollars, and thereupon, on the 4th day of November, 1881, your oratrix did make, execute and deliver to said defendant a deed of conveyance to said property in consideration of said sum of nineteen thousand dollars, and because of her helpless and destitute condition aforesaid, of which said defendant took advantage in securing said deed. That at the time of purchase of said mortgage indebtedness, to wit, August 13, 1881, and thence until the said 4th day of November, 1881, the interest of your oratrix in said property, to wit, the equity of redemption, was of the value of forty-five thousand five hundred dollars and more, which the said defendant during all said times knew; and in taking the interest of your oratrix in said property, and paying therefor the sum of nineteen thousand dollars, the said defendant took advantage of

his position as holder of said mortgage indebtedness, and of the helpless and poverty-stricken condition of your oratrix. Your oratrix further avers: That the rents, issues and profits of said property received by defendant since said 4th day of November, 1881, amount to the sum of one hundred thousand dollars. That your oratrix is and always has been ready and willing, and hereby offers, to pay said defendant the said sum of nineteen thousand dollars, with legal interest thereon, and also the amount of said mortgage indebtedness with interest and costs, and to redeem said property from said mortgage liens and said judgment.

8 That said defendant has been absent from said State of California for a period aggregating four years since the 4th day of November, 1881. Wherefore your oratrix prays that notwithstanding said deed executed by her to defendant, she be adjudged entitled to redeem said property; that an accounting of the rents, issues and profits received by defendant therefrom since the 4th day of November, 1881, be ordered by this Court, and your oratrix be credited therewith accordingly upon such redemption; and for such other further or different relief as may be conformable to equity and good conscience, and as the nature and circumstances of this case may require, and shall seem meet to this honorable Court.

May it please your Honors to grant unto your oratrix a writ of subpœna, to be directed to the said

James Phelan, thereby commanding him at a certain day and under a certain pain therein to be limited personally to appear before this honorable Court, and then and there, full, true, direct and perfect answers make to all and singular the premises; and further, to stand to, perform and abide such further order, direction, and decree therein as to this honorable Court shall seem meet. And your oratrix shall ever pray.

GEORGE D. COLLINS,

Counsel and Solicitor for Complainant, Francisca  
Leyba de Martin.

Endorsed: Filed, September 16, 1890.

L. S. B. SAWYER, Clerk.

---

**SUBPÆNA.**

9

UNITED STATES OF AMERICA.

*Circuit Court of the United States, Ninth Judicial Circuit,  
Northern District of California.*

**In Equity.**

The President of the United States of America—  
Greeting to James Phelan:

You are hereby commanded that you be and appear in said Circuit Court of the United States aforesaid, at the Court-room in San Francisco, on the third day of November, A. D. 1890, to answer a Bill of Complaint exhibited against you in said Court by Fran-

cisca Leyba de Martin, who is a citizen of Mexico, and to do and receive what the said Court shall have considered in that behalf. And this you are not to omit, under the penalty of five thousand dollars. Witness, the Honorable Melville W. Fuller, Chief Justice of the Supreme Court of the United States, this 16th day of September, in the year of our Lord one thousand eight hundred and ninety, and of our Independence the 115th.

[SEAL.]

L. S. B. SAWYER,  
Clerk.

*Memorandum pursuant to Rule 12, Supreme Court,  
U. S.*

You are hereby required to enter your appearance in the above suit, on or before the first Monday of November next, at the clerk's office of said Court, pursuant to said bill; otherwise the said bill will be taken *pro confesso*.

L. S. B. SAWYER,  
Clerk.

Endorsed:

UNITED STATES MARSHAL'S OFFICE, }  
Northern District of California. }

I hereby certify that I received the within writ on the 16th day of September, 1890, and personally served the same on the 15th day of October, 1890, on James Phelan, by delivering to and leaving with James Phelan, said defendant named herein, personally, at the City

and County of San Francisco, in said District, and attested copy thereof.

[SEAL.]

W. G. LONG, U. S. Marshal.

By James R. Deane, Deputy.

San Francisco, October 15, 1890.

Filed, October 15, 1890.

L. S. B. SAWYER, Clerk,

By F. D. Monckton, Deputy Clerk.

11 *In the Circuit Court of the United States, Ninth Judicial Circuit, Northern District of California.*

Francisca Leyba de Martin,	}	No. 10,884.
Complainant,		
<i>v.</i>	}	In Equity.
James Phelan, Defendant.		

### Demurrer to Bill.

The demurrer of the above named defendant, James Phelan, to the Bill of Complaint of the above named plaintiff: This defendant by protestation, not confessing or acknowledging all or any of the matters or things in the said Bill of Complaint contained to be true in such manner and form as the same are herein set forth and alleged, doth demur to the said Bill, and for cause of demurrer showeth:

1. That it appeareth by the plaintiff's own showing that he is not entitled to the relief prayed by the

Bill, or to any relief in equity against this defendant.

2. That the said Bill does not state that the deed of conveyance therein described was intended by the parties thereto, or either of them, as security for money loaned, or for any indebtedness of plaintiff to defendant.

3. That the said Bill does not state or show that this defendant took any unfair or grossly oppressive advantage of plaintiff's necessities, or exercised any undue influence over said plaintiff, or that the consent of plaintiff would not have been given to the said conveyance had such cause not existed; or that plaintiff  
12 has ever notified this defendant of her intention to rescind said conveyance, or has ever offered this defendant before the bringing of this suit to restore everything of value received from defendant by plaintiff in consideration of said conveyance; or that plaintiff exercised reasonable diligence to rescind the said conveyance promptly upon discovering the facts entitling her to rescind the said conveyance.

4. That the Bill shows on its face that plaintiff has been guilty of laches, and that her right to relief is and ought to be barred in equity by the provisions of Section 343 of the Code of Civil Procedure of the State of California.

Wherefore, and for divers other good causes of demurrer appearing on said Bill, this defendant doth demur thereto, and he prays the judgment of this Honorable Court whether he shall be compelled to make any answer to the said Bill; and he humbly prays



to be hence dismissed with his reasonable costs in this behalf expended.

FRANK J. SULLIVAN,  
WM. F. HERRIN,  
Solicitors for Defendant.

I hereby certify that the foregoing demurrer is, in my opinion, well founded in point of law.

WM. F. HERRIN,  
Of Counsel for Defendant James Phelan.

13 STATE OF CALIFORNIA, }  
City and County of San Francisco. } ss.

James Phelan being duly sworn, deposes and says that he is the defendant above named, and that the foregoing demurrer is not interposed for delay.

JAMES PHELAN.

Subscribed and sworn to before me this 24th day of November, 1890.

[SEAL.]

R. D. McELROY,  
Notary Public.

Endorsed: Due service of a true copy of the within demurrer, at the City and County of San Francisco, this first day of December, A. D. 1890, is hereby admitted.

GEO. D. COLLINS,  
Solicitor for Complainant.

Filed December 1, 1890.

L. S. B. SAWYER,  
Clerk.

---

## Copy of Order Sustaining Demurrer.

At a stated term, to wit: The July term, A. D. 1891, of the Circuit Court of the United States of America, of the Ninth Judicial Circuit, in and for the Northern District of California, held at the Court-room in the City and County of San Francisco, on Monday, the 14th day of September, in the year of our Lord one thousand eight hundred and ninety-one.

Present: The Honorable James H. Beatty, U. S. District Judge, District of Idaho; The Honorable Thomas P. Hawley, U. S. District Judge, District of Nevada.

Francisca Leyba de Martin	}	No. 10,884.
James Phelan.		

The demurrer to the Bill of Complaint heretofore argued and submitted to the Court for consideration, having been duly considered, and the opinion of the Court having been read, it is ordered that said demurrer be and the same hereby is sustained, with leave to complainant to amend said Bill of Complaint on or before the next rule day.

---

15 *In the Circuit Court of the United States, Ninth Circuit, Northern District of California.*

Francisca L. de Martin,	}	No. 10,884.
Complainant,		
<i>v.</i>	}	
James Phelan,		
Respondent.		

### Enrollment.

The complainant filed her Bill of Complaint herein on the 16th day of September, 1890, which is hereto annexed.

A subpœna to appear and answer in said cause was thereupon issued, returnable on the 3d day of November, A. D. 1890, which is hereto annexed. The respondent appeared herein on the 3d day of November, 1890, by William F. Herrin and Frank J. Sullivan, Esqs., his solicitors.

On the 1st day of December, 1890, a demurrer was filed herein, which is hereto annexed.

On the 14th day of September, 1891, an order sustaining said demurrer was made and entered, a copy of which order is hereto annexed.

16 Thereafter a decree was duly signed, filed and entered, in the words and figures following, to wit: At a stated term, to wit, the July term, A. D. 1891, of the Circuit Court of the United States of America, of the Ninth Judicial Circuit, in and for the Northern District of California, held at the Court-room in the City and County of San Francisco, on Friday, the 16th day of

October, in the year of our Lord one thousand eight hundred and ninety-one.

Present: The Honorable Thomas P. Hawley, U. S. District Judge, District of Nevada, assigned to hold and holding Circuit Court of the United States for the Northern District of California.

Francisca Leyba de Martin,	}	No. 10,884.
Complainant,		
<i>v.</i>	}	
James Phelan,		
Defendant.	)	

**Decree.**

The demurrer to the Bill of Complaint herein having been duly considered and sustained for want of equity in the bill on the 14th day of September, 1891, and the complainant having been granted until the first Monday in October, 1891, in which to file an amended bill, and the complainant having failed to file said amended bill within the time allowed therefor, or to obtain any extension of time for filing the same; now, therefore, it is ordered, adjudged and decreed that complainant's Bill of Complaint be and the same is hereby dismissed, and that the defendant James Phelan do have and recover of and from the complainant Francisca Leyba de Martin, his costs herein expended.

HAWLEY,  
Judge.

Endorsed: Filed and entered October 16, 1891.

L. S. B. SAWYER,  
Clerk.

18 Whereupon said pleadings, subpœna, copy of order and decree are hereto annexed, said final decree being duly signed, filed and enrolled, pursuant to the practice of said Circuit Court.

Attest, etc.,

[SEAL.]

L. S. B. SAWYER, Clerk.

By W. B. Beazley, Deputy Clerk.

Endorsed: Enrolled papers. Filed, October 16, 1891.

L. S. B. SAWYER, Clerk.

By W. B. Beazley, Deputy Clerk.

—

19 *In the Circuit Court of the United States of America,  
Ninth Judicial Circuit, Northern Dis-  
trict of California.*

Francisca L. de Martin, Appellant,	} On Appeal.
<i>v.</i>	
James Phelan, Respondent.	

**Assignment of Errors.**

Comes now Francisca L. de Martin, the appellant herein, by George D. Collins, her attorney and solicitor, and says that the said Circuit Court of the United States committed manifest error in sustaining the demurrer interposed by the defendant and respondent in the above entitled suit, and accordingly committed manifest error in rendering and entering its judgment and decree thereupon in favor of said

defendant and respondent. All of which is apparent from the record and proceedings in said suit. Whereas by the law of the land, the judgment and decree of said Court ought to have been given for the said plaintiff and appellant, Francisca L. de Martin, and against the said defendant and respondent, James Phelan, and the said appellant Francisca L. de Martin prays the judgment and decree aforesaid be reversed, annulled, and altogether held for naught, and that she be restored to whatever she has lost by occasion of the said judgment and decree.

GEORGE D. COLLINS,  
Attorney for said Appellant, Francisca L. de Martin.

Endorsed: Filed December 30, 1891.

L. S. B. SAWYER,  
Clerk.

---

20 *In the Circuit Court of the United States of America,  
Ninth Judicial Circuit, Northern Dis-  
trict of California.*

Francisca L. de Martin, Appellant, }  
v. }  
James Phelan, Respondent. }

**Appeal and Allowance Thereof.**

The above named plaintiff and complainant, Francisca L. de Martin, considering herself aggrieved by the decree and judgment of said Court, entered in

the above entitled suit on the 16th day of October, 1891, doth hereby appeal from the said decree and judgment, to the United States Circuit Court of Appeals for the Ninth Circuit, and she prays that this appeal be allowed, and that a transcript of the record and proceedings and papers upon which said decree and judgment was made, duly authenticated, be sent to the said United States Circuit Court of Appeals.

GEORGE D. COLLINS,  
Attorney for said Appellant.

And now, to wit: on the 30th day of December, 1891, it is ordered that the foregoing appeal be allowed as prayed for; the appellant having filed her assignment of errors.

HAWLEY,  
Judge.

Endorsed: Filed December 30, 1891.

L. S. B. SAWYER,  
Clerk.

21 At a stated term, to wit, the November term, A. D. 1891, of the Circuit Court of the United States of America, of the Ninth Judicial Circuit, in and for the Northern District of California, held at the Court-room in the City and County of San Francisco, on Wednesday, the 30th day of December, in the year of our Lord one thousand eight hundred and ninety-one.

Present: The Honorable Thomas P. Hawley, U. S. District Judge, District of Nevada.

Francisca Leyba de Martin	}	No. 10,884.
v.		
James Phelan.	}	

### Order Allowing Appeal and Fixing Bond.

Upon motion of George D. Collins, Esq., counsel for complainant, it is ordered that an appeal to the United States Circuit Court of Appeals for the Ninth Circuit, from the final decree heretofore filed and entered herein, be and the same hereby is allowed, and that a certified transcript of the record and all proceedings herein be forthwith transmitted to the said United States Circuit Court of Appeals. It is further ordered that the bond for costs on appeal be and the same hereby is fixed at the sum of five hundred dollars.

---

### Citation.

25

UNITED STATES OF AMERICA—SS.

The President of the United States to James Phelan,  
greeting:

You are hereby cited and admonished to be and appear at a United States Circuit Court of Appeals, for the Ninth Circuit, to be holden at the City of San Francisco, in the State of California, on the 25th day of January next, pursuant to an appeal filed in the Clerk's office of the Circuit Court of the United States, for the Northern District of California, wherein Fran-



cisca L. de Martin is appellant, and you are respondent, to show cause, if any there be, why the decree and judgment rendered against the said appellant as in the said appeal mentioned, should not be corrected, and why speedy justice should not be done to the parties in that behalf.

Witness, the Honorable Thomas P. Hawley, Acting Judge of the United States Circuit Court, Ninth Circuit, for the Northern District of California, this second day of January, A. D. 1892.

THOMAS P. HAWLEY,  
U. S. Judge.

Endorsed: Service of the within citation, by copy thereof, on this 2nd day of January, 1892, is admitted.

WM. F. HERRIN,  
Attorney for Respondent, James Phelan.

Filed January 2, 1892.

L. S. B. SAWYER,  
Clerk U. S. Circuit Court, Nor. Dist. Cal.

---

### Bond on Appeal.

Know all men by these presents: That we, Francisca L. de Martin, as principal, and Joseph Parker and C. Knickerbocker, as securities, are held and firmly bound unto James Phelan in the full and just sum of five hundred dollars, to be paid to the said James Phelan, his certain attorney, executors, admin-

istrators or assigns ; to which payment, well and truly to be made, we bind ourselves, our heirs, executors and administrators, jointly and severally, by these presents. Sealed with our seals and dated this second day of January, in the year of our Lord one thousand eight hundred and ninety-two.

Whereas, lately at a session of the Circuit Court of the United States, for the Northern District of California, in a suit pending in said Court between Francisca L. de Martin as complainant, and James Phelan as defendant, a decree was rendered against the said Francisca L. de Martin, and the said Francisca L. de Martin having obtained from said Court the allowance of an appeal to reverse the decree in the aforesaid suit, and a citation directed to the said James Phelan citing and admonishing him to be and appear at a United States Circuit Court of Appeals for the Ninth Circuit, to be holden at San Francisco in the State of California.

Now, the condition of the above obligation is such that if the said Francisca L. de Martin shall prosecute said appeal to effect, and answer all damages and costs, if she fail to make her plea good, then the above obligation to be void ; else to remain in full force and  
23 virtue.

[SEAL.]

FRANCISCA L. DE MARTIN.

[SEAL.]

JOSEPH PARKER.

[SEAL.]

C. KNICKERBOCKER.

Acknowledged before me the day and year first above written.  
 F. D. MONCKTON,  
 Commissioner U. S. Circuit Court, Northern District  
 of California.

UNITED STATES OF AMERICA, }  
 Northern District of California. } ss.

Joseph Parker and C. Knickerbocker being duly sworn, each for himself deposes and says that he is a freeholder in said District, and is worth the sum of five hundred dollars, exclusive of property exempt from execution, and over and above all debts and liabilities.

JOSEPH PARKER.

C. KNICKERBOCKER.

Subscribed and sworn to before me this 2d day of January, A. D. 1892.

F. D. MONCKTON,  
 Commissioner of U. S. Circuit Court, Northern  
 District of California.

Endorsed: Form of bond and sufficiency of securities approved.  
 HAWLEY,  
 Judge.

Filed January 2, 1892.

L. S. B. SAWYER,  
 Clerk U. S. Circuit Court, Northern District, Cal.

---

24 *In the Circuit Court of the United States, Ninth  
Judicial Circuit, Northern District of  
California.*

Francisca L. de Martin	}	No. 10,884.
<i>v.</i>		
James Phelan.		

**Clerk's Certificate to Transcript.**

I, L. S. B. Sawyer, Clerk of the Circuit Court of the United States of America, of the Ninth Judicial Circuit, in and for the Northern District of California, do hereby certify the foregoing twenty-three written pages, numbered from 1 to 23 inclusive, to be a full, true and correct copy of the record, and all proceedings in the therein entitled suit, and that the same together constitute the transcript of the record upon appeal to the United States Circuit Court of Appeals for the Ninth Circuit.

In testimony whereof, I have hereunto set my hand, and affixed the seal of said Circuit Court, this 11th day of January, 1892.

[SEAL.]	L. S. B. SAWYER,
Clerk U. S. Circuit Court, Northern District of Cali- fornia.	

No. 26.

---

IN THE  
United States Circuit Court of Appeals  
FOR THE  
NINTH CIRCUIT.

---

FRANCISCA L. DE MARTIN, *Appellant*, )  
v. )  
JAMES PHELAN, *Appellee*. )

---

APPELLANT'S BRIEF.

---

GEORGE D. COLLINS,  
*Counsel for Appellant.*

*Filed April*.....1892.

---

.....*Clerk.*

---

FILED  
APR - 9 1892



IN THE  
**United States Circuit Court of Appeals**  
FOR THE  
**NINTH CIRCUIT.**

---

FRANCISCA L. DE MARTIN,	}
<i>Appellant,</i>	
<i>v.</i>	
JAMES PHELAN,	}
<i>Appellee.</i>	

---

**APPELLANT'S BRIEF.**

I.

This is a suit in equity to redeem certain realty from mortgages held by defendant ; the defendant interposed a demurrer to the Bill, and the Circuit Court sustained it upon the ground of want of equity. The plaintiff declining to amend, judgment and decree followed in favor of defendant dismissing the Bill. (Transcript, pages 1, 13, 16, 18 ) From that decree this appeal is taken, and the error assigned is : that

the Circuit Court erred in sustaining the demurrer, and, of course, that therefore its decree is erroneous, and ought to be reversed with instructions to overrule the demurrer. (Transcript, page 19.)

## II.

The Bill clearly presents the following facts, viz :

1. The relation of mortgagor and mortgagee.

*McMillan v. Richards*, 9 Cal., 406, 412 ;

*Goldtree v. McAllister*, 86 Cal., 105 ;

*Evansville v. Indiana*, 20 Am. Law Reg. N. S.,  
676.

2. That the mortgagee purchased the equity of redemption for the sum of \$19,000, whereas he knew at the time that its actual market value was the sum of \$45,500.

*Biddle v. Brizzolera*, 64 Cal., 358-362.

3. That at the time of said purchase the plaintiff, the owner of the equity of redemption, was in indigent circumstances—in great need, with no available means of support all of which defendant well knew, and that he took advantage of plaintiff's necessitous condition and used his position as mortgagee to secure, and did secure, the equity of redemption at a gross under-valuation, and for a grossly inadequate consideration.



Upon the foregoing facts, the appellant maintains that she is entitled to the relief demanded in her Bill, and that her position in this respect is correct is made manifest by the following authorities, viz :

- Peugh *v.* Davis, 96 U. S., 337, per Field, J.  
 Villa *v.* Roderiguez, 12 Wall., 339.  
 Russell *v.* Southard, 12 How., 154.  
 Dougherty *v.* Mc Colgan, 6 Gill & J., 275.  
 Baugher *v.* Merryman, 32 Md., 191, *et seq.*  
 Perkins *vs.* Drye, 3 Dana, 177, *et seq.*  
 Barnes *v.* Brown, 71 N. C., 509.  
 Lynell *v.* Lyford, 72 Me., 280.  
 Patterson *v.* Yeaton, 47 Me., 306.  
 Schekel *v.* Hopkins, 2 Md. Ch., 90.  
 Green *v.* Butler, 26 Cal., 601-603, to be read  
 with  
 Odell *v.* Montross, 68 N. Y., 504.  
 Goodman *v.* Pledger, 14 Ala., 118.  
 Ford *v.* Olden L. R., 3 Eq. Cas., 461, per,  
 Stuart, V. C.  
 Holdridge *v.* Gillespie, 2 Johns. Ch., 30.  
 2 Jones on Mortgages, § 1046.

Of course, we do not claim that mere inadequacy of consideration will avoid a conveyance or other contract, but we do say that the relation of mortgagor and mortgagee existing, conjoined with the fact that the mortgagor is deprived of free agency by reason of poverty, and consequent pressing need, that a sale of

the equity of redemption to the mortgagee who has full knowledge of all the facts, for less than one-half of its value, establishes a *prima facie* case of an involuntary transfer of the equity of redemption, and shows that the mortgagee took advantage of the necessities of his debtor, in procuring the transfer, and more especially where it is expressly averred, as here, that the mortgagee availed himself of his position and of the pressing needs of his poverty-stricken debtor, and actively procured the conveyance of the equity of redemption for less than half its value.

To constitute a *prima facie* case, it is sufficient for the appellant to show the relation of mortgagor and mortgagee, combined with gross inadequacy of consideration ; and the transfer of the equity of redemption will be held invalid unless the mortgagee, assuming the burden of proof thus cast upon him, satisfies the Court that the transfer was as voluntary as though the parties stood upon an equal footing, and dealt at "arm's length."

This position is fully sustained by the authorities cited ; it does not proceed on the theory of actual fraud, or that of a trust relation, but rather upon the necessity of a free, voluntary and independent consent on the part of the mortgagor.

Its policy is to avoid the undue influence likely to arise from the financial coercion attending the relation of mortgagor and mortgagee, and to preserve the free agency of the mortgagor ; it is nothing more than the

ancient doctrine of the Court of Chancery, the doctrine of the protection of the weak and helpless against the aggressiveness and rapacity of the strong and powerful.

3 Pomeroy's Equity Jur., § 1,193, note 1.

McKinstry *v.* Conly, 12 Ala., 683.

Vernon *v.* Bethell, 2 Eden, 113.

Tooms *v.* Conset, 1 Atk., 261.

Sheckel *v.* Hopkins, *supra*.

Perkins *v.* Drye, *supra*.

Villa *v.* Roderiguez, *supra*.

Dougherty *v.* McColgan, *supra*.

2 Pomeroy's Equity Jur., § 951.

Nor does the fact that in some of the cases cited the mortgage transferred the legal title to the mortgagee, make any difference in the application of the principle. It has always been the established doctrine of equity that a mortgage merely created a lien, and nothing more, and it has been side by side that the principle we invoke and the equitable doctrine pertaining to the nature of a mortgage, have grown and become firmly established in the system of equity jurisprudence.

3 Pomeroy's Equity Jur., § 1,204.

Odell *v.* Montross, 68 N. Y., 503.

Vernon *v.* Bethell, *supra*.

Toomes *v.* Conset, *supra*.

On the point of laches, the following authorities show it to be utterly devoid of merit:

Hall *v.* Arnot, 80 Cal., 355, 356.

2 Pomeroy's Eq. Jur., § 1,053.

1 Perry on Trusts, § 166.

Michoud *v.* Girod, 4 How., 561.

Manning *v.* Hayden, 5 Sawy., 380.

Hall *v.* Russell, 3 Sawy., 515, 516.

Varick *v.* Edwards, 1 Hoff. Ch., 383.

Wood on Limitations, § § 59, 60.

We respectfully submit that the judgment is erroneous, and should be reversed with instructions to the lower Court to overrule the demurrer.

Respectfully submitted,

GEORGE D. COLLINS,

Attorney for Appellant.

No. 26.

---

IN THE  
United States Circuit Court of Appeals  
FOR THE  
NINTH CIRCUIT.

---

FRANCISCA L. DE MARTIN, *Appellant*,  
v.  
JAMES PHELAN, *Appellee*.

---

Appellant's Supplemental Brief.

---

GEORGE D. COLLINS,

*Counsel for Appellant.*

Filed April 18 1892.

.....  
.....  
.....  
*Clerk.*

---



IN THE  
United States Circuit Court of Appeals  
FOR THE  
NINTH CIRCUIT.

---

FRANCISCA L. DE MARTIN,

*Appellant,*

*v.*

JAMES PHELAN,

*Appellee.*

---

Appellant's Supplemental Brief.

---

I.

Gross inadequacy of consideration coupled with a necessitous condition on the part of the vendor of which the vendee had full knowledge at the time of the transaction, are sufficient in equity to justify the inference *prima facie*, that the deed was procured by

undue influence ; and especially is it true where there existed between the parties a financial relation which conferred on the vendee a power and influence over the vendor, the natural tendency of which was to impair the vendor's free agency and to subject him to the rapacity of the vendee. This principle is particularly applicable to the relation of mortgagor and mortgagee.

In *Chesterfield v. Janssen*, 2 Ves., 155, Lord Hardwicke in classifying the different cases of fraud, actual and constructive, mentioned as the second class those cases where "It may be apparent from the intrinsic nature and subject of the bargain itself ; such as no man in his senses and not under delusion would make on the one hand, and as no honest and fair man would accept on the other ; which are inequitable and unconscientious bargains ;" and as the third class he enumerated "*Fraud, which may be presumed from the circumstances and condition of the parties contracting ; and this goes farther than the rule of law, which is, that it must be proved, not presumed. But it is wisely established in the Court of Chancery, to prevent taking surreptitious advantage of the weakness or necessity of another, which knowingly to do is equally against conscience, as to take advantage of his ignorance.*"

This constructive fraud is known to modern law as undue influence, and the principle itself is expressively and instructively applied by the following authorities, all of which fully sustain appellant's position :



Wood *v.* Abrey, 3 Mad. Ch., 423.

Underhill *v.* Harwood, 10 Ves., 219, per Lord Eldon.

Proof *v.* Hines. (Cases temp. Talbot, 111.)

Hough *v.* Hunt, 2 Ohio, 495.

Brown *v.* Gaffney, 28 Ill., 149 (case of mortgage).

McCants *v.* Bee, 1 McCord Ch., 385.

McCormick *v.* Malon, 5 Blackf., 531.

Brown *v.* Campbell, 2 A. K. Mar., 127.

Harding *v.* Wheaton, 2 Mason, 388.

Hyndman *v.* Hyndman, 19 Vt., 13.

1 Story Equity Jurisprudence, § 239.

3 Leading Cases in Equity, pg. 140, Third American Edition. (Hare & Wallace's notes.)

The averments of the bill are sufficient.

Whelan *v.* Whelan, 3 Cowen, 571, 572.

## II.

Under the circumstances narrated in the bill, the deed stands as security for the re-payment of the debt due the appellee ; in other words, equity construes the transaction to be a mortgage, and holds it ineffective to convert the previously-existing relation of mortgagor and mortgagee into that of vendor and vendee.

2 Jones on Mortg., § 1,046.

“The parties will be held to their original relation of mortgagor and mortgagee, unless the transaction shall, upon a close examination of its circumstances, appear to be perfectly fair and no advantage taken of the latter by the former.”

*Schekel v. Hopkins*, 2 Md. Ch., 90.

“Unless the transaction appears to be fair and un-mixed with any advantage taken by the mortgagee of the necessitous circumstances of the mortgagor, equity will hold the parties to their original relation of debtor and creditor.”

*Dougherty v. McColgan*, 6 Gill & J., 275.

“The question, then, for the Chancellor to ascertain, when the mortgagor seeks to redeem, after an absolute sale to the mortgagee of the equity of redemption, is: Has the mortgagee used his mortgage for the purpose of coercing the mortgagor to sell him the equity of redemption for less than its value, and for less than others would have given, at a fair sale; and if the Chancellor find that such influence was used in the purchase of the equity of redemption, and that this influence produced the results described; that is, benefit or advantage to the mortgagee, and prejudice to the mortgagor by selling his right to redeem for less than its value, and less than others would give for it, then he ought to interfere, and hold that the mortgagor may still redeem.”

Goodman *v.* Pledger, 14 Ala., 118.

“ *To give validity* to such a sale by the mortgagor, it must be shown that the conduct of the mortgagee was in all things fair and frank, and that he paid for the property what it was worth.”

Villa *v.* Roderiguez, 12 Wall., 339.

Therefore the transaction having failed to convert the relation of mortgagor and mortgagee into that of vendor and vendee, the limitation prescribed by law within which a bill to redeem may be filed, is found in Section 346 of the Code of Civil Procedure of California, and that section is as follows, viz. :

“ An action to redeem a mortgage of real property with or without an account of rents and profits, may be brought by the mortgagor, or those claiming under him, against the mortgagee in possession, or those claiming under him, unless he or they have continuously maintained an adverse possession of the mortgaged premises for five years after breach of some condition of the mortgage.”

Jarvis *v.* Woodruff, 22 Conn., 548 ;

Hughes *v.* Edwards, 9 Wheat., 489 ;

Slicer *v.* Bank of Pittsburg, 16 How., 571.

Under the interpretation of this section by the Supreme Court of California in *Hall vs. Arnot*, 80 Cal., 355, 356, the bill does not show laches. The obnox-

ious transfer was made November 4, 1881, the bill was filed September 16, 1890, and it avers the absence of the appellee from the State, for the period of four years, intermediate that time, and Section 351 of the Code of Civil Procedure provides that "if after the cause of action accrues, he departs from the State, the time of his absence is not part of the time limited for the commencement of the action." Besides, if the averments of the bill are sustained, the appellee will be chargeable as a trustee *ex maleficio* (2 Pom. Eq. Jur., § 1,053, 1 Perry on Trusts, § 166), and the period of limitation would not preclude the maintenance of a suit at any time within ten years.

Wood on Limitations, § § 59, 60 ;  
 Varick *v.* Edwards, 1 Hoff. Ch., 383 ;  
 Hall *v.* Russell, 3 Sawy., 515, 516 ;  
 Manning *v.* Hayden, 5 Sawy., 380 ;  
 Michoud *v.* Girod, 4 How., 561.

Respectfully submitted,

GEORGE D. COLLINS,

Counsel for Appellant.

No. 26.

---

IN THE  
UNITED STATES CIRCUIT COURT OF APPEALS,  
FOR THE NINTH CIRCUIT.

---

FRANCISCA L. DE MARTIN,

*Appellant,*

vs.

JAMES PHELAN,

*Appellee.*

---

BRIEF FOR APPELLEE.

---

H. L. GEAR,  
*Of Counsel.*

WM. F. HERRIN,  
*Solicitor for Appellee.*

---

FILED  
APR 14 1892



IN THE  
United States Circuit Court of Appeals

FOR THE NINTH CIRCUIT.

---

FRANCISCA L. DEMARTIN,

*Appellant,*

*vs.*

JAMES PHELAN,

*Appellee.*

---

No. 26.

APPELLEE'S BRIEF.

The only question to be considered is whether the demurrer to the bill was properly sustained. This question is answered by the opinion of the learned Judge who decided the cause, reported in 47 Fed. Rep., 761, a copy of which is appended to this brief.

I. *No case of Intended Mortgage by Deed Absolute.*

The bill alleges that the defendant had purchased mortgages against her property, amounting to the sum of \$185,000, and that by means of the said mortgage indebtedness he induced the complainant to transfer the property to him for \$19,000, and "thereupon, on the 4th day of November, 1881, your oratrix did make, execute and deliver to said defendant a deed of conveyance to said property

*in consideration of said sum of nineteen thousand dollars, and because of her helpless and destitute condition aforesaid, of which said defendant took advantage in securing said deed*" (Transcript, pp. 8-9). There is no pretence of any allegation that either party understood or intended that this conveyance was to be a mortgage, or was in any manner to secure the repayment of the \$19,000 purchase money paid therefor, or to secure the payment of the original mortgage debt. It is evident that the real consideration of the deed was the extinguishment of the mortgage debt, amounting to \$185,000, besides the purchase money paid, aggregating \$204,000, for the property.

The mortgages were merged in the title and extinguished by operation of law, in the absence of any intent of the parties to keep them alive.

Whether a deed is in effect a mortgage is a question of the agreement or intention of the parties to effect a security for indebtedness.

*People vs. Irwin*, 18 Cal., 117.

*Sears vs. Dixon*, 33 Cal., 330.

*Henley vs. Hotaling*, 41 Cal., 22.

*Montgomery vs. Spect*, 55 Cal., 352.

*Davis vs. Baugh*, 59 Cal., 574.

*Cook vs. Lion Fire Ins. Co.*, 67 Cal., 369.

## II. *No case shown for Rescission or Cancellation of the Conveyance.*

There is no pretense of any allegations in the complaint of any false representations or fraudulent conduct of the defendant inducing the deed, nor is it alleged in the terms of the Civil Code of California upon the subject of undue influence as



a ground for rescission, that the defendant obtained any “*unfair advantage*” by the use of “*confidence*” or “*authority*,” or took any “*grossly oppressive and unfair advantage*” of complainant’s “*necessities or distress.*”

Civil Code, Secs. 1575, 1689.

Nor is there any pretense that any notice of rescission or offer of restitution of the money paid was given or made within a reasonable time, which is absolutely essential in order to effect a rescission of the conveyance.

Civil Code, Sec. 1691.

*Fratt vs. Fiske*, 17 Cal., 380.

*Gifford vs. Carvill*, 29 Cal., 589, 593.

*Morrison vs. Lods*, 39 Cal., 381.

*Barfield vs. Price*, 40 Cal., 535.

*Bohall vs. Diller*, 41 Cal., 533.

*Herman vs. Haffenegger*, 54 Cal., 161, 164.

*Collins vs. Townsend*, 58 Cal., 615, 616.

*Goodwin vs. Goodwin*, 59 Cal., 560, 562-3.

*Burkle vs. Levy*, 70 Cal., 250.

*Bailey vs. Fox*, 78 Cal., 396.

*Wainwright vs. Weske*, 82 Cal., 193, 196.

*Hammond vs. Wallace*, 24 Pac. Rep., 837.

*Grymes vs. Sanders*, 93 U. S., 55, 62.

### III. *No Case of Trust Ex Maleficio.*

There being no allegations of fraud, undue influence or oppression, or of any breach of trust relation, or of such gross inadequacy of consideration as to amount *per se* to constructive fraud, there is no more ground for the enforcement of a trust *ex maleficio*, than there is for a rescission of the deed.

A trust *ex maleficio* is fastened upon the con-

science of an offending party who has acted unconscientiously by circumvention, imposition, fraud, undue influence or oppression, or by taking undue advantage of a confidential relation, or by other wrongful act.

2 Pom. Eq. Jur., Sec. 1053.

1 Perry on Trusts, 166.

Civil Code, Sec. 2224.

#### INADEQUACY OF CONSIDERATION.

The only pretense of inadequacy of consideration is the difference between \$204,000 and \$230,500. There is no allegation that complainant could have obtained any higher sum for the property than was paid by the defendant, or that he prevented her in any manner from obtaining more, if she could. It is very evident that if he had foreclosed the mortgage he could have obtained the title for \$19,000 less than he paid.

There may be an adequate consideration to sustain a grant without the necessity of full compensation to the grantor upon his estimate of value; and it is well settled that mere inadequacy of consideration in that respect, where it is unconnected with circumstances of fraud, or is not so gross and excessive as to shock the conscience and moral sense of mankind, and to be demonstrative of fraud, is not ground for setting aside or cancelling a conveyance in equity, as between persons competent to contract and occupying no fiduciary relation to each other.

*Phillips vs. Pullen*, 45 N. J. Eq., 5; 16 Atl.

Rep., 11; 18 Atl. Rep., 849.

*Copis vs. Middleton*, 2 Madd., 556.

- McHarry vs. Irvin*, 85 Ky., 322.  
*Wood vs. Craft*, 85 Ala., 260.  
*Pennybacker vs. Laidley*, 11 S. E. Rep., 39.  
*Weber vs. Weitling*, 18 N. J. Eq., 441.  
*Eyre vs. Potter*, 15 How., 42, 60.  
*Matheney vs. Sanford*, 26 W. Va., 386.  
*Bridges vs. Linder*, 60 Iowa, 190.  
*Osgood vs. Franklin*, 2 Johns. Ch., 1, 23.  
 1 Story's Eq., Secs. 245, 246.  
 Pomeroy's Eq. Jur., Sec. 926.

Even where the inadequacy of consideration or price is so gross as to be demonstrative of fraud, "the *fraud*, and not inadequacy of price, is the true and only cause for the interposition of equity, and the granting of relief."

Pomeroy's Eq. Jur., Vol. 2, Sec. 927.

#### IV. *No Mortgage under Rules Governing Trust Relations—No Trust Relation between Mortgagor and Mortgagee.*

It is manifest that complainant has staked her whole bill of complaint upon the theory that the bare relation of mortgagor and mortgagee, accompanied by partial inadequacy of consideration, will vitiate the conveyance from the mortgagor to the mortgagee, and that it will be avoided at the mere will of the mortgagee, upon an offer to redeem.

The authorities cited by complainant, so far as they hold that a mortgagee is bound to show that a conveyance to him by the mortgagor of the "equity of redemption" was for the full value of the property, else the mortgagor may avoid it, rest upon the application of the principle of a *trust relation* be-

tween the parties, growing out of the common law doctrine that a mortgage passed the legal title and made the mortgagee a trustee of the mortgagor, leaving only in him a mere "*equity of redemption.*"

But under the jurisprudence of this State there is no trust relation between a mortgagee and a mortgagor, as it is impossible that the mortgagee could take a legal title at the time of the mortgage, since *no contract for a lien can transfer title to property in this State, notwithstanding an express agreement to the contrary.*

Civil Code, Secs. 2888, 2924, 2925.

*Taylor vs. McLain*, 64 Cal., 514.

*Jackson vs. Lodge*, 36 Cal., 28.

*Cunningham vs. Hawkins*, 27 Cal., 606, 607.

A mortgagor remains the owner of *the legal estate*, to all intents and purposes, until deprived thereof by foreclosure, sale, or subsequent voluntary conveyance by himself, and the mortgagee has a mere lien upon the property as security for his debt, and has *no estate in the land.*

*Goodenow vs. Ewer*, 16 Cal., 467.

*Dutton vs. Warschauer*, 21 Cal., 621.

*Mack vs. Wetzlar*, 39 Cal., 247.

*Williams vs. S. C. Mining Assn.*, 66 Cal., 201.

By virtue of the rule as now obtaining in most of the States, the mortgagee takes no estate in the land, but has only a lien thereon as security for the debt until foreclosure. His interest in the land is regarded as personalty, and is subject to the rules governing that species of property. \* \* \* *As the relationship of mortgagor and mortgagee is not considered to be of a fiduciary character, the mortgagee, whether in possession or not, is entitled to purchase from the mortgagor his estate and interest in the land.* In the event of the mortgagor's title being sold under execution the mortgagee may buy and hold it adversely to the mortgagor.

Lawson's Rights and Remedies, Vol. 6, Sec. 3031.

There can be no doubt that a mortgagee can make a *bona fide* purchase of the equity of redemption—if indeed we may use these terms in the present condition of the law as to mortgages in this State—and thereby acquire an absolute title. \* \* \* Independent of authority, no argument is necessary to show that, upon principle, a mortgagor has the same capacity to contract with reference to his interest in the mortgaged property that he has in respect to any other property.

*Green vs. Butler*, 26 Cal., 601, 602–3.

The California Code contemplates the extinguishment of a mortgage lien by conveyance to the mortgagee in satisfaction of the debt.

Civil Code, Sec. 2910.

The rule which prohibits a trustee from purchasing the property of a *cestui que trust* stands upon the proposition stated by the Chancellor in *Whichcote vs. Lawrence* (3 Ves., 740), that one who undertakes to act for another in any matter shall not in the same matter act for himself. It applies in all cases where the duty which the trustee has to perform in respect to the property is inconsistent with his becoming a purchaser for his own use. \* \* \* Such a purchase \* \* \* is a constructive fraud, because the natural tendency is mischievous and harmful. \* \* \* Unless the mortgagee in possession is a trustee for the mortgagor, there is no ground upon which he can be precluded from purchasing. *It is clear that no trust relation between the mortgagor and mortgagee is created by the execution of the mortgage, unaccompanied by possession.* The mortgage under our law is a security merely. The mortgagee has, by virtue of his mortgage, no estate in or title to the land, or the right of possession, before or after the mortgage debt becomes due. *He owes the mortgagor no duty to protect the equity of redemption.* \* \* \* He may buy in any outstanding title and hold it against the mortgagor. (*Cameron vs. Irwin*, 5 Hill, 280; *Williams vs. Townsend*, 31 N. Y., 415; *Shaw vs. Bunny*, 13 Week. R., 374; S. C. 2 De G., J. & S., 468.) There is, in truth, no relation analogous to that of *trustee* and *cestui que trust* between the mortgagor and mortgagee created by the execution of the mortgage. The mortgagee is not a trustee of the legal title, because under our law, he has no title whatever. (*Kortright vs. Cady*, 21 N. Y., 342, and cases cited.) *He may deal with the mortgagor in respect to the mortgaged estate, upon the same footing as any other person; he may buy in incumbrances for less than their face, and hold them against the mortgagor for the full amount; he may do what*

any other person may do, and his acts are not subject to impeachment, simply because he is a mortgagee. (*Darcy vs. Hall*, 1 Vern., 48; *Knight vs. Majoribanks*, 2 Mac. N. & G., 10; *Chambers vs. Waters*, 3 Sim., 42; 3 Sug. on V. and P., 227.)

*Ten Eyck vs. Craig*, 62 N. Y., 419-422.

In *Hyndman vs. Hyndman* (19 Vt., 13), the rule requiring a mortgagee to show affirmatively that a sale of the equity of redemption was fair and adequate, is expressly grounded upon the theory of a trust relation, giving the *cestui que trust* an option to avoid it unless such showing is made; while the distinction is recognized that in New York, where such purchases are allowed, it is incumbent upon the mortgagor to impeach the fairness of the sale.

It is again affirmed in a recent case in New York that the relation of trustee and beneficiary does not exist between mortgagor and mortgagee.

*Mills vs. Mills*, 115 N. Y., 86.

In *Walker's Administratrix vs. Farmers' Bank* (14 Atl. Rep., 819), the Supreme Court of Delaware say:

In Delaware, between mortgagor and mortgagee, there is not any such fiduciary or other relation as will prevent the latter from purchasing the entire interest of the former in the mortgaged premises. In England and some of the American States, the early common law doctrine prevails, to greater or less extent, that the mortgagee has the legal title to the mortgaged premises. \* \* In this State this view has been greatly modified. Here, a mortgage, though in form a conveyance of the land, is a mere security for the payment of money. The mortgagor in possession \* \* is the real owner of the land, and the mortgagee \* \* \* has but a chattel interest. \* \* \* It is therefore evident that, if the mortgagee may purchase the mortgagor's interest in England and elsewhere, where, under the early common law doctrine, his means and opportunities for oppression and inequitable advantage are relatively greater than in Delaware, he may with equal if not greater reason and propriety be permitted to do so here. And it may also be observed that in a case like the present, where, at the time the controverted

conveyance was made, the mortgagee had neither the legal title to nor the possession of the mortgaged premises, a *less exacting scrutiny* of the transaction may be necessary than where he has either or both of these, and consequently the greater means and opportunities for the *coercion and oppression of the mortgagor* (p. 821.)

In the foregoing case the mortgagee had realized a profit on the resale of the premises after the conveyance to him by the mortgagor, but there being no fraud or oppression practiced by the mortgagee, the conveyance was not disturbed.

In *Chapman vs. Mull* (7 Ired. Eq., 292), it was held that the principles applicable to dealings between trustee and *cestui que trust*, as adopted by courts of equity, requiring the trustee "to show affirmatively that such dealing was fair and for a reasonable consideration, so as to exclude the inference that advantage was taken of the relation existing between the parties," does not apply "to the relation existing between mortgagor and mortgagee." The court says:

Dependence and the duty of protection are not involved in the relation. The parties have definite rights, stand at "arm's length," and may deal, subject only to the ordinary principle; with this difference—the relation is always a circumstance which creates suspicion and aids in the proof of *an allegation of oppression and undue advantage, where there is a gross inadequacy of price, and other circumstances tending to show fraud* (pp. 294-5.)

This authority shows clearly that the mere allegation of existence of the relation of mortgagor and mortgagee, and of the fact that the price agreed upon was less than full value, cannot constitute a cause of action where no ultimate facts are alleged showing *oppression and undue advantage or fraud*.

## REVIEW OF APPELLANT'S AUTHORITIES.

The cases cited by complainant's counsel, where the old rule growing out of a trust relation between mortgagor and mortgagee is applied (which rule has no application in California), do not sustain such a bald position as that taken by counsel.

In the case of *Peugh vs. Davis* (96 U. S., 332), the original mortgage was by deed absolute on its face, passing the legal title and leaving a mere equity of redemption; and there was no satisfactory proof that the equity of redemption was ever released. The pretended release was for a *grossly* inadequate price, and the mortgagor remained in possession. The court held that a subsequent release might be made of the equity of redemption; that there is nothing in the policy of the law forbidding it, but that such release must be clearly shown and “*appear by a writing importing in terms a transfer of the mortgagor's interest;*” and “*must also be for an adequate consideration; that is to say, it must be for a consideration which would be deemed reasonable if the transaction were between other parties dealing in similar property in its vicinity.*” (96 U. S., 337.)

There is no allegation in this complaint that the price paid for the conveyance would be deemed unreasonable if the transaction was between other parties dealing in similar property; and it seems evident that a difference between a valuation of \$204,000 and \$230,500, for the same parcel of land, is not more marked than might exist between buyer and seller in any negotiation. The difference is certainly not such gross inadequacy as to shock the moral sense, and be demonstrative of fraud.

It appears from the complaint that the circum-



stances of *Peugh vs. Davis* do not exist in the case at bar. No title here passed by the mortgage, but the mortgagor has conveyed the legal title by unmistakable terms of grant, and does not appear to have remained in possession after the conveyance; and there is no such *marked* or *gross* inadequacy of consideration as existed in *Peugh vs. Davis*.

In *Sheckell vs. Hopkins* (2 Md. Ch., 90, 91), cited for complainant, it was held that where no disposition or attempt appears on the part of the mortgagee to influence the mortgagor to part with the property at an undervaluation, or to coerce the will or influence the conduct of the mortgagor, the case stands free from every possible prejudice which could be brought to bear against it because the property was mortgaged to the former.

In *Goodman vs. Pledger* (14 Ala., 114), the complaint, wholly unlike that in the case at bar, alleged that it was understood and agreed that the conveyance obtained from the mortgagor was a security for indebtedness, and was obtained under the assurance that time would be allowed for repayment of the purchase money. The court held, upon the preponderance of evidence, that the conveyance was a mortgage, and that it was obtained under inequitable circumstances; and remarked that where a mortgagee has "used his mortgage for the purpose of *coercing* the mortgagor to sell the equity of redemption for less than its value and *for less than others would have given at a fair sale,*" the chancellor should interfere and hold that the mortgagor may still redeem.

There is nothing in the case at bar to indicate that the price paid for the property was less than

others would have given at a fair sale, and no agreement for a mortgage security, or *coercion* of the mortgagor, is alleged.

In *Baugher vs. Merryman* (32 Md., 185, 191), the deed was procured by urgent solicitation of the mortgagee, without paying any money for it, and by pressing upon the mortgagor the alternative of being turned out of house and home, or being allowed to remain if the property was conveyed. The bill alleged that the deed was intended only as a further means of securing the debt, and was given on the distinct understanding that all the proceeds of resale above the debt, interest and expenses, should be paid to the mortgagor. The bill also charged fraud in the procuring of the conveyance; and in all of these respects, that case is wholly unlike the case at bar.

In *Perkins vs. Drye* (3 Dana, 170, 177), the conveyance to the mortgagee was alleged to have been intended as a mortgage, and to have been executed upon an understanding that the time for redemption was to be extended. The court held that there was no colorable consideration for the conveyance; that it was false upon its face; and that the court would *set aside such sale*, and allow the mortgagor to redeem, when, by *the influence* of his incumbrance, it appears that the mortgagee has obtained a conveyance “*for less than others would give.*”

It neither appears in the present bill what others would have given for the complainant's property, nor that defendant used his incumbrance, or any other means, to prevent the complainant from finding another purchaser, if possible, who would pay

more for her property than the defendant was willing to pay.

Counsel for complainant is unfortunate in citing the case of *Barnes vs. Brown* (71 N. C., 509), as sustaining the present bill. That case holds that the mortgagee may purchase the equity of redemption from one to whom the original mortgagor has assigned or transferred it, and that *in the absence of fraud, and of any agreement to the contrary*, he acquires by such purchase an absolute estate in the land, and his mortgage debt is extinguished.

The complaint in this case does not show that the complainant was the mortgagor, or was personally responsible to the mortgagee for the indebtedness. *Non constat*, but that she may be the grantee of the mortgagor. If so, the decision in *Barnes vs. Brown* is an authority directly against her.

In *Dougherty vs. McColgan* (6 Gill. & J., 275), the conveyance to the mortgagee was *accompanied by a defeasance*, and the main question was whether it was the *intention of the parties* to create a security for indebtedness or a conditional sale, and it was held that the intention was one of security.

In *Holbridge vs. Gillespie* (2 Johns. Ch., 30), the court applied the *doctrine of trusts* to a mortgagee *in possession*, who, by advantage of his possession, had obtained a new lease of the premises, of which it was held that he was *trustee* for the mortgagor; and the court also held that a release obtained by the mortgagee of the equity of redemption of one-half of the mortgaged premises, *without consideration*, by an agreement which was false *on its face*, would not be sustained in equity or allowed to bar a right of redemption.

In *Linnell vs. Lyford* (72 Me., 282), it was held that a deed of the equity of redemption in *mere consideration of the mortgage deed*, without any new consideration, where the mortgage deed was *accompanied by a defeasance* agreeing to quit-claim the property to the mortgagor upon payment of the mortgage debt, the mortgage notes not being surrendered, was but a security for the same indebtedness.

In *Odell vs. Montross* (68 N. Y., 504), the title of the mortgagor was held not to have been extinguished by a mere payment of fifty dollars, accompanied by a written receipt *not purporting to convey or transfer any interest in lands*. The *obiter* remarks of the court as to avoiding a purchase “for *fraud*, actual or constructive, or for any *unconscionable advantage* taken by the mortgagee in obtaining it,” and that “it will be sustained only when *bona fide*; that is, when in all respects *fair*, and for an adequate consideration,” are no authority to sustain the present bill.

In *Villa vs. Rodriguez* (12 Wall., 339), the complaint alleged that the conveyance was made from the mortgagor, to the mortgagee *as security* for the mortgage debt; and it appeared that it was for a grossly inadequate consideration; that the mortgagee had acted harshly and oppressively, and drew in the mortgagors to convey by assurances that he was taking the step for their interest, and did not wish to speculate upon them, and leading them to understand that it was only security for the debt. The Court say:

The testimony of Rodriguez alone is sufficient to turn the scale against him. He cannot repudiate the assurances upon which his

grantors were drawn in to convey. To permit him to do so would give triumph to iniquity.

The court further say, in speaking of the relations between mortgagor and mortgagee, and the principles that apply when the equity of redemption is purchased by the mortgagee:

*Where confidential relations and the means of oppression exist, the scrutiny is severer than in cases of a different character.*

The case shows that Rodriguez not only assumed to be a trustee of the legal title, but that he was the *brother* of the widow, and *uncle* of the children whom he sought to defraud.

The language of the decision must be construed in connection with the context and the facts of the case; and when so construed there is nothing in the case to sustain the position assumed by the complainant's counsel in reference to the present bill.

In *Russell vs. Southard* (12 How., 154), cited for complainant, the court say:

*But strong expressions, used with reference to the particular facts under consideration, however often repeated by subsequent writers, cannot safely be taken as fixing an abstract rule. We think that, inasmuch as the mortgagee in possession may exercise an undue influence over the mortgagor, especially, if the latter be in needy circumstances, the purchase by the former of the equity of redemption, is to be carefully scrutinized, when fraud is charged; and that only constructive fraud or an unconscientious advantage which ought not to be retained, need be shown to avoid such a purchase. But we are unwilling to lay down a rule which would be likely to prevent any prudent mortgagee in possession, however fair his intentions may be, from purchasing the property by making the validity of the purchase depend on his ability afterwards to show that he paid for the property all that any one would have been willing to give. We do not deem it for the benefit of mortgagors that such a rule should exist.*

The facts of the case showed that the original mortgage was by deed absolute, with a separate

agreement to reconvey, which the defendant claimed created only a conditional sale, but which the court declared constituted the transaction a mortgage. It is evident that the title passed to the mortgagee, leaving only an equity of redemption in the mortgagor. The surrender of this equity was obtained by the mortgagee by securing a delivery up of the defeasance without consideration, although the mortgage was for only about one-third of the total value of the land. It was held that the obtaining of the equity of redemption under such circumstances was constructively fraudulent, and the deed was held to remain a mortgage.

No such state of facts or circumstances appear in this case, and the doctrine of *Russell vs. Southard*, notwithstanding the evident trust relation between the parties, is against the contention of the complainant in this case, where there is not a shadow of trust relation, and no pretense that the deed was intended as security for indebtedness, and the consideration paid therefor was at least 204-230ths of the value of the land, including \$19,000 in cash, besides the mortgage indebtedness.

The case of *Patterson vs. Yeaton* (47 Me., 306,) is inapplicable, as it turns wholly upon the failure to revest title under an oral agreement to purchase an equity of redemption by the mere surrender to the mortgagee of an unrecorded deed which the mortgagee had given to the mortgagor when the mortgage was taken, the mortgage remaining uncanceled of record, after the oral agreement was made.

The case of *Ford vs. Olden* (L. R. 3 Eq. Cas., 461), was a case in which a sale by a bankrupt mortgagor

of his equity of redemption to the mortgagee for a greatly inadequate consideration was set aside on a bill by his assignee in bankruptcy as being fraudulent and void *as to the creditors of the bankrupt*, on the ground that the mortgagee had used pressure and *purchased for less than others would have given*. the Vice-Chancellor cites the opinion of Lord Redesdale “that the courts view transactions between the mortgagee and mortgagor with jealousy, and will set aside the sale of the *equity of redemption* where, *by the influence of his position, the mortgagee has purchased for less than others would have given, and where there are circumstances of misconduct in obtaining the purchase.*”

In the case of *McKinstry vs. Conly* (12 Ala., 683,) reference is made *obiter* to authorities decided under the old system of distinction between the legal title and the “equity of redemption,” as between mortgagor and mortgagee, holding that a court of equity “will protect the mortgagor against contracts entered into with the mortgagee, impairing or destroying the *equity of redemption*. *From the relative condition of the two parties it looks with jealousy on all such contracts. It will not tolerate a clause in the mortgage that the mortgagor shall not redeem, as that is an inseparable incident of the contract, and will relieve against a sale of the equity of redemption for a grossly inadequate price, from the power which the mortgagee has over the mortgagor.*” Yet the case *decides* that this principle had no application to the case made before the court.

There evidently can be no *equity of redemption* in any true or proper sense unless there is a legal title in the mortgagee. And it is evident that where an

advantage is given at law by the possession of the legal title after condition broken, and equity must regard the owner of the legal title as a trustee of the mortgagor for the protection of the latter, it may consistently apply the rules governing a trust relation to dealings between the parties.

The case of *Toomes vs. Conset* (3 Atk., 261), merely expresses the familiar rule of equity that it will not permit any agreement in a mortgage that the estate shall become absolute in the mortgagee in any event, so as to vest an indefeasible estate at law. It has no application here.

In the case of *Vernon vs. Bethell* (2 Eden, 110), there was a clear showing that the deed was taken as a security, and as an easy mode of obtaining possession as mortgagee, there being no intention to cancel or merge the mortgage, and a redemption was therefore decreed.

The foregoing are all of the cases cited by appellant on the question of her right to redeem, and none of them sustain the contention here made, even upon the theory that there is an *equity of redemption*, in the proper sense, in a mortgagor as against a mortgagee who holds the legal title in trust for him.

But there is no such equity of redemption in this State, and no reason appears why a mortgagor and mortgagee should not deal with each other in this State in all respects as independent contracting parties, subject to the ordinary rules governing contracts. No ground appears under any of those rules for avoiding the executed contract set forth in the bill.

It is evident that there can be no right of re-



demption in this case without an avoidance in equity of the conveyance of complainant to defendant. There is no pretense that that conveyance was *intended as a security* for the cash paid therefor, or for the prior mortgage indebtedness, the lien of which was extinguished by the deed given in satisfaction thereof.

Civil Code, Sec. 2910.

There is no ground stated in the bill upon which a court of equity would be justified in avoiding that conveyance, and the demurrer was properly sustained for that reason.

## II. Limitation and Laches.

The demurrer was also properly sustained on the ground of limitation and laches.

The case of *Hull vs. Arnott* (80 Cal., 355, 356), has no application, for the manifest reason that in this case, unlike that, the cause of action depends upon the *setting aside* in equity of an absolute conveyance, and the enforcement of a *constructive trust*, before there can be any pretense of a right to redeem; and that cause of action is clearly barred by limitation and laches.

*Michoud vs. Girod* (4 How., 561), and *Manning vs. Hayden* (5 Sawy., 380), were expressly distinguished as cases of *actual fraud*, creating a *constructive trust*, and yet it was admitted by both those cases that courts of equity, even in cases of exclusive jurisdiction, act *in analogy* to the statutes of limitation, though not governed by them.

But it has been expressly and repeatedly adjudged that where State courts have *concurrent jurisdiction*

of a case of equity cognizance, the State Statute of Limitations applicable to such a case is *obligatory* upon the Federal courts of equity.

*Norris vs. Haggin*, 12 Sawyer, 47.

*Miller vs. McIntyre*, 6 Pet., 67.

*Badger vs. Badger*, 2 Wall., 94.

Broderick's Will, 21 Wall., 518.

*Sullivan vs. Portland and K. R. R. Co.*, 94 U. S., 811.

*Coddington vs. Pensacola and Ga. R. R. Co.*, 103 U. S., 409.

A cause of action to enforce a constructive trust is barred in four years, if the *cestui que trust* is not in possession, and the action is not based upon fraud.

C. C. P., Sec. 343.

*Lakin vs. Sierra Buttes Co.*, 11 Sawyer, 244 *et seq.*

*Curry vs. Allen*, 34 Cal., 254.

The four years' limitation of Sec. 343 applies to all suits in equity not strictly of concurrent cognizance in law and equity.

*Piller vs. S. P. R. R. Co.*, 52 Cal., 42.

Where the relief must proceed upon the ground of fraud, the limitation is three years after the facts were or might have been discovered.

*Norris vs. Haggin*, 12 Sawyer, 47.

*Curry vs. Allen*, 34 Cal., 254.

The same limitation applies to cases of constructive fraud.

*Boyd vs. Blankman*, 29 Cal., 20, 21, 46.

When no time of the discovery of fraud is al-

leged, the facts must be presumed to have been known to the complainant at the time of or immediately after their occurrence.

*Sublette vs. Tinney*, 9 Cal., 425.

*LeRoy vs. Mulliken*, 59 Cal., 281.

The limitation against relief in equity begins to run as soon as the party might have applied to a court of equity for relief.

*Norris vs. Haggin*, 12 Sawyer, 56-7.

Story's Eq. Jur., Sec. 1521*a*.

The ordinary rules of limitation apply as against an *implied* or *constructive trust*, and the statute runs from the date of the acts charged as constituting it.

*Lammer vs. Stoddard*, 103 N. Y., 673.

*Mills vs. Mills*, 115 N. Y., 86.

*Wilmerding vs. Russ*, 33 Conn., 68, 77.

The demurrer was also properly sustained upon the ground of laches, no facts or circumstances being alleged to excuse the delay of nine years in filing this bill.

No formal plea of the statute of limitations is necessary to raise the defense of laches, neglect or acquiescence, in a court of equity, and equity will act by analogy to the State statute and dismiss the bill for laches whether the State statute is properly pleaded or not.

*Lakin vs. Sierra Buttes Co.*, 11 Sawy., 232, 242.

*Sullivan vs. Portland, etc., R. R. Co.*, 94 U. S., 811.

*Harris vs. Hillegras*, 66 Cal., 79.

Since all the relief that could be granted to the

complainant upon this bill is such as might be granted if she had attempted to rescind the contract, she should be held responsible in equity for the same laches which she has shown in respect to its rescission.

It is well settled that upon the discovery or knowledge of facts constituting a fraud which has induced a contract, the defrauded party must promptly elect whether he will rescind the contract or not, and if he once evinces an intention not to rescind, the contract becomes as to him irrevocably established.

Unless a contract or conveyance is rescinded with reasonable diligence, it becomes irrevocable, and the lapse of many months or years without any notice of rescission or offer of restitution, is a bar to an annulment or cancellation of the contract or conveyance in equity.

Civil Code, Secs. 1689, 1691.

*Fratt vs. Fiske*, 17 Cal., 380.

*Hammond vs. Wallace*, 24 Pac. Rep., 837.

*Davis vs. Read*, 37 Fed. Rep., 423-4.

*Barfield vs. Price*, 40 Cal., 535.

*Bohall vs. Diller*, 41 Cal., 533.

*Collins vs. Townsend*, 58 Cal., 615, 616.

*Burkle vs. Levy*, 70 Cal., 250.

*Bailey vs. Fox*, 78 Cal., 396.

A party seeking equitable relief to cancel a conveyance upon the ground of fraud “*must, upon discovery of the facts, at once announce his purpose and adhere to it,*” and will not be permitted to “*play fast and loose,*” or speculate upon a change in value of the property.

*Grymes vs. Sanders*, 93 U. S., 55, 62, and cases cited.

An attempt to fasten on a purchaser a *constructive trust*, even though he occupied a *confidential relation*, must fail unless made *within a reasonable time*; and even the statutory time will not be allowed if the party having the right stands by and sees another dealing with the property in a manner inconsistent with the trust, *and makes no objection*.

Ashhurst's Appeal, 60 Penn., 290, 316.

We submit that, for the foregoing reasons, and for the reasons clearly and ably set forth in the opinion of Judge Hawley, hereto appended, the judgment should be affirmed.

WM. F. HERRIN,  
Solicitor for Appellee.

H. L. GEAR,  
Of Counsel.

Opinion of Hon. T. P. Hawley, U. S. District Judge,  
in De Martin vs. Phelan.

Circuit Court, N. D. California. September 14, 1891.

(Reported in 47 Federal Reporter, pp. 761-5.)

MORTGAGES—REDEMPTION—INADEQUACY OF CONSIDERATION.

Complainant, in her bill praying that she be allowed to redeem certain property, alleged that on a named date she was the owner of such property, subject to mortgage liens for some \$185,000; that thereupon defendant had purchased these liens "as a means of securing title to said property, and for no other purpose," and had foreclosed them; that at this time complainant was in indigent circumstances, without available means of support for her family, and defendant, knowing her destitute state, took advantage of his position, and by means of this mortgage indebtedness induced complainant to sell him her equity of redemption for the sum of \$19,000, it being worth at least \$45,000, as defendant then knew. *Held* that, in the absence of allegations of fraud, undue influence, or confidential relations, the bill is without equity.

In equity. Bill to redeem land from mortgage.

*Geo. D. Collins*, for complainant.

*Wm. F. Herrin*, for defendant.

HAWLEY, J. (*orally*). The defendant demurs to complainant's bill in equity, praying for a decree allowing her to redeem certain property, and for an accounting of the rents, issues, and profits therefrom since November 4, 1881. The bill alleges that on November 4, 1881, complainant was the owner in fee of certain lands, specifically described in the bill, situated in Santa Clara County; that at said date, and for some time prior thereto, said property was subject to mortgage liens, two of which were held by the Bank of San Jose and the other by David Belden, aggregating the sum of \$185,000; that the liens held by the Bank of San Jose were foreclosed on the 13th of August, 1881, by judgment and decree of the Superior Court in Santa

Clara County; that prior to said decree “all of said mortgage liens were assigned and transferred to said defendant; that said defendant purchased said mortgage indebtedness as a means of securing the title to said property, and for no other purpose;” that at the time of said purchase complainant “had no available means of support for herself and family, and was in indigent circumstances and in great need, and such continued to be her condition up to and including the 4th day of November, 1881, all of which said defendant well knew; \* \* \* that said defendant thereupon took advantage of the destitute condition of your oratrix, and by means of the said mortgage indebtedness purchased by him as aforesaid, induced your oratrix to transfer the said property to him in consideration of the sum of nineteen thousand dollars;” that thereupon, on the 4th day of November, 1881, “your oratrix did make, execute, and deliver to said defendant a deed of conveyance of said property in consideration of the said sum of nineteen thousand dollars, and because of the helpless and destitute condition aforesaid, of which said defendant took advantage in securing said deed; that at the time of the purchase of said mortgage indebtedness, \* \* \* and thence until the said 4th of November, 1881, the interest of your oratrix in said property, to wit, the equity of redemption, was of the value of forty-five thousand five hundred dollars and more, which the said defendant during all said times knew, and in taking the interest of your oratrix in said property, and paying therefor the sum of nineteen thousand dollars, the said defendant took advantage of his position as holder of said mortgage indebtedness,

and of the helpless and poverty-stricken condition of your oratrix." Under these averments, what were the inducements held out by the defendant, which caused her to sell her equity of redemption? Did he make any false representations as to the value of the property? How did defendant take advantage of complainant's destitute condition? There is no allegation in the bill of any fraud on the part of defendant. There is no averment that any relations of confidence or trust existed between the parties, no claim that the deed of the equity of redemption was intended as a mortgage, no pretense that any fraudulent representations of any kind were made; no steps were taken by defendant to prevent other parties from buying complainant's interest in the property. There are no averments that defendant, either in purchasing the mortgage liens or procuring the deed, took any unfair or grossly oppressive advantage of complainant's necessities, or in any manner exercised any undue or improper influence over the complainant. He seems simply to have made an offer for her interest which, on account of her necessities, and the embarrassed condition of the property, she accepted. The bill avers that defendant's object in purchasing the mortgage liens was to secure the title to the property, and that by said purchase, and the knowledge that complainant was without means, and in a helpless and destitute condition, he gave her only \$19,000 for her equity of redemption at a time when he knew that her interest in the property was worth at least \$45,000.

Complainant seeks to maintain this action upon the theory that a mortgagee holds a financial ad-



vantage over the mortgagor which, of itself, has a tendency to prevent him from dealing with the mortgagee on an equal footing, and that such a relation places the mortgagor under the power of the mortgagee and destroys free agency. In support of this theory counsel for complainant contends that in cases of this character the principles of law are almost as stern and inflexible as those which govern transactions between a *cestui que trust* and his trustee, and that the sale of the property, under such circumstances as are alleged in the bill, will never be sustained, unless *bona fide*, and for a full, fair, and adequate consideration. Can this contention be sustained? What is the relation of mortgagor and mortgagee? Under the law of California, and most of the other States, the mortgagee takes no estate in the land, but has only a lien thereon as security for the debt until foreclosure. He can at any time make a *bona fide* purchase of the equity of redemption or interest of the mortgagor, and thereby acquire an absolute title to the mortgaged premises. There is no trust relation between the mortgagor and the mortgagee when unaccompanied by possession. The mortgagee does not owe the mortgagor any duty to protect the equity of redemption. There is no relation analogous to that of trustee and *cestui que trust* between the mortgagor and mortgagee created by the execution of the mortgage. No fiduciary character exists between them which prevents the mortgagor from buying the property at foreclosure sale, and holding the title thus acquired adversely to the mortgagor. The mortgagee can at all times deal with the mortgagor in respect to the property mortgaged precisely

upon the same footing as any other person, and may purchase liens or claims against the property for less than their face value, and hold them against the mortgagor for the full amount. Under these general principles, which are well settled and supported by numerous authorities,—*Green vs. Butler*, 26 Cal., 601; *Ten Eyck vs. Craig*, 62 N. Y., 421; *Walker vs. Bank* (Del. Err. & App.), 14 Atl. Rep., 823; 6 Lawson, Rights, Rem. & Pr., § 3031,—how can it consistently be claimed that the averments of the bill in this case are sufficient to maintain this action? Parties who are in poor and destitute circumstances, if they have any property, and wish to dispose of it, are often compelled by their necessities to sell their property for less than its real value; but if they obtain all that they ask for it, or voluntarily accept what is offered, and there is no fraud, deceit, oppression, improper or undue influence, or confidential relations existing between them, courts of equity have no jurisdiction, power, or authority to set aside such transactions. There is in most cases a contest between the purchaser and the seller of real property; the purchaser usually endeavoring to buy the property at the lowest price the owner is willing to take, and the owner trying to get the highest price the purchaser is willing to pay. In a certain sense the purchaser, with ready money at his command, takes advantage of the circumstances of the owner who is poor, and by reason of his poverty is willing to sell for whatever is offered. When the parties are dealing at arms-length in the open market, and no unfair or improper measures are used or misrepresentations made, it would be absurd to say that a court of equity, years afterwards,

when the party selling had met with financial success, and acquired sufficient means to repay the purchase money, could be called upon to annul the sale. It is only in cases where the *bona fides* of the transaction is called in question, and when fraud or other like causes above enumerated is alleged, that courts of equity are authorized to interfere. In such cases the relation of mortgagor and mortgagee is "always a circumstance which creates suspicion, and aids in the proof of an allegation of oppression and undue advantage, where there is a gross inadequacy of price, and other circumstances tending to show fraud." *Chapman vs. Mull*, 7 Ired. Eq., 294. The authorities cited and relied upon by complainant are cases of this character. Thus, in *Peugh vs. Davis*, where the action was to set aside a release of the equity of redemption, it being alleged and claimed that the money paid for the release was in fact a further loan of money, and that the release was given only as security for such loan, and the question to be determined was as to the true character of the transaction, the court very properly said that the transaction will "be closely scrutinized, so as to prevent any oppression of the debtor; \* \* \* that a release to the mortgagee will not be inferred from equivocal circumstances and loose expressions. \* \* \* The release must also be for an adequate consideration; that is to say, it must be for a consideration which would be deemed reasonable if the transaction were between other parties, dealing in similar property in its vicinity. Any marked undervaluation of the property in the price paid will vitiate the proceeding." 96 U. S., 337. The same rule was applied in *Villa*

vs. *Rodriguez*, 12 Wall., 323, to enable the court to determine whether a deed absolute upon its face was a mortgage. In *Russell vs. Southard*, 12 How., 154, the same doctrine is announced and applied to a mortgagee in possession of the property, where the question of the purchase of the equity of redemption was in dispute. The court, in the course of the opinion, indicating the necessity of confining the rule to the proper class of cases, said:

But strong expressions, used with reference to the particular facts under consideration, however often repeated by subsequent writers, cannot safely be taken as fixing an abstract rule. We think that, inasmuch as the mortgagee in possession may exercise an undue influence over the mortgagor, especially if the latter be in needy circumstances, the purchase by the former of the equity of redemption is to be carefully scrutinized when fraud is charged; and that only constructive fraud, or an unconscientious advantage which ought not to be retained, need be shown, to avoid such a purchase. But we are unwilling to lay down a rule which would be likely to prevent any prudent mortgagee in possession, however fair his intentions may be, from purchasing the property, by making the validity of the purchase depend on his ability afterwards to show that he paid for the property all that any one would be willing to give. We do not deem it for the benefit of mortgagors that such a rule should exist.

The general principles announced in these and other cases cited by complainant, when applied to a similar state of facts, should always be followed; but they have no application to the particular facts of this case, and cannot be considered as authorities in support of the theory upon which complainant relies to sustain this action. To determine the character of the transaction, it would be unfair to confine the consideration solely to the alleged valuation of complainant's interest and the amount paid by defendant therefor. To be just to both parties, the entire transaction should be inquired

into. Is it reasonable to believe that any other person, with knowledge of the amount of the mortgage liens, in the light of the foreclosure proceedings, the accumulated costs and interest on the money, and the limited time allowed for redemption, would have paid more than \$19,000 for complainant's interest in the property? The fact that \$204,000 was paid for property alleged to be worth \$230,500, under such circumstances, certainly does not show such a marked undervaluation or inadequacy of price as would, of itself, shock the conscience, or raise any presumption of fraud or undue advantage that would justify a court of equity to annul the sale. The demurrer is sustained.



No. 26.

---

IN THE  
United States Circuit Court of Appeals  
FOR THE  
NINTH CIRCUIT.

---

FRANCISCA L. DE MARTIN, *Appellant,* }  
v }  
JAMES PHELAN, *Appellee.* }

---

PETITION FOR RE-HEARING

---

GEORGE D. COLLINS,  
*Counsel for Petitioner*

*Filed July*.....*1892.*

.....*Clerk.*

---

FILED  
JUL 28 1892





IN THE  
United States Circuit Court of Appeals  
FOR THE NINTH CIRCUIT.

---

FRANCISCA L. DE MARTIN,

*Appellant,*

*v.*

JAMES PHELAN,

*Appellee.*

---

PETITION FOR RE-HEARING.

---

*To the Honorable, the United States Circuit Court of  
Appeals for the Ninth Circuit, and to the Judges  
thereof:*

The appellant herein respectfully petitions for a re-hearing of this cause and upon the following grounds, viz :

I.

The Court is undoubtedly in error in ruling that the deed from appellant to appellee is not to be held a mortgage simply because it was intended as a deed.

Under the circumstances narrated in the bill of complaint, the deed was in legal effect and by construction of Equity nothing but a mortgage; true, it was not a conventional mortgage, nor need it be such to entitle the plaintiff to maintain a bill to redeem; it is enough if the circumstances are such as to render applicable that doctrine of Chancery which holds a deed of the equity of redemption, made for an inadequate consideration by a necessitous debtor to his mortgagee, constructively a mortgage,—not because the parties so intended, but because it is essential that the transaction be so considered in order that Equity may make effective its principle governing the subject. To all intents and purposes, the deed intended by the parties as a conveyance is just as much a mortgage as though it purported to be such on its very face. It is upon that ground alone that *bills to redeem* have been entertained and sustained, notwithstanding the fact that the deed in question was intended to be an absolute conveyance of the title, and no attempt was ever made or even suggested that the deed first be set aside, rescinded or cancelled as such; but in every case the Court proceeded and granted the relief on a bill to redeem and simply considered the deed a mortgage, although the parties had no such intention at the time of its execution. And this practice is in strict accord with the principles of equity in analogous cases; in fact, it is a part of the history of equity jurisprudence, that when a debtor executed an absolute deed to his

creditor in payment of his indebtedness or as security for its payment, although it was intended that the title should vest absolutely in the creditor, the Court of chancery held it to be but a mortgage and permitted a redemption despite the deed, even going so far as to hold that parol evidence was admissible to show the facts. It is hardly necessary, however, to advert to analogous cases to show that no matter what may be the intention of the parties, if the transaction is such as to come within the equitable doctrine of constructive mortgage, a redemption will be decreed without rescission or cancellation of the instrument intended as an absolute conveyance. The instrument is not disregarded, but its effect is restricted to that of a mortgage, and to all intents and purposes it is just as complete a mortgage as though it was entirely conventional and is to be given the same judicial recognition as though it purported on its face to be a mortgage and not a deed. If, then, the instrument before the Court—the deed of November 4, 1881—was a formal mortgage, it at once becomes impressively obvious that the doctrine of rescission which dominates the opinion of the Court, together with the inferential theory of laches which rests upon it, would have no more place in the case than the statute *De Donis Conditionalibus*. Nor is the argument even plausible, that the defendant was entitled to know whether the plaintiff elected to treat the deed as a mortgage; he is presumed to know the law, and having purchased under the facts narrated in

the bill, the doctrine of *caveat emptor* applies to him (*Christy v. Sullivan*, 50 Cal., 339), and he cannot be heard to say that he speculated on the possibility of the plaintiff reserving her objection until it was too late to urge it. He cannot be permitted to convert what equity deems a mortgage into a deed absolute. "Once a mortgage, always a mortgage," is one of the elementary principles of equity jurisprudence, and no Court of Chancery would be loyal to the fundamental law of its being, did it permit the mere lapse of time to have the magic effect of transforming a mortgage into a deed. Before the advent of the decision in this case, it was never held that a period of ten years would bar the right to redeem. The limit prescribed was *twenty years*, and laches were never predicated on a shorter period. (*Jarvis v. Woodruff*, 22 Conn., 548; *Hughes v. Edwards*, 9 Wheat., 489; *Slicer v. Bank of Pittsburg*, 16 How., 571; *Kinna v. Smith*, 3 N. J. Eq., 16.) And it is therefore quite impossible to understand why *laches* should be found to exist in this case, as the suit was entered *eight* years and *ten* months after the day on which the transaction was had and the deed executed. The Court is entirely in error, in asserting the period to be nearly ten years, and even if it was, on the point of laches, that would not be an unreasonable length of time, as is manifest from the authorities just cited. The Court cites *Twin Lick Oil Co. v. Marbury*, 91 U. S., 592, in support of its views; but that case is differentiated from this by the charac-

ter of the property there involved, the fluctuating character of which is expressly referred to by the Court as the basis of its ruling ; and besides, the Court states explicitly that the rule it there applied would have no application to a case where real estate was the subject matter of the litigation. Again, that was not a case of a mortgage, for that is *sui generis* and stands on its own peculiar basis. There, too, the doctrine of rescission was resorted to, on the point of laches ; whereas in this case, that doctrine has no relevancy to the case, as we have already seen. In that case there existed an option to avoid the conveyance, and it was necessary to exercise that option, and, upon that theory, the defense of laches was sustained ; in this case, there never was an option and no necessity of exercising one, as the transaction was a mortgage *ab initio*, by construction of law. The Marbury case was one of fraud ; this case is not, and only incidentally involves the issue of undue influence. In short, if this case is viewed in the light of the authorities holding the transaction to be a mortgage, then all doubts vanish and the right of the plaintiff to redeem becomes clearly established ; and if the Court will determine the question of laches as applied to the right to redeem from a mortgage—the only proper method of deciding the question—it will readily perceive the error of its ruling in affirming the decree on the ground of laches.

We will now refer the Court to some of the author-

ities supporting this, the first ground of our position. That the mortgagor knowingly surrendered, transferred the property and never intended to reclaim, is of no consequence in a case of this nature, was expressly so adjudged in the parallel case of *Villa v. Roderiguez*, 12 Wall., 339, where that very language was used in deciding the point.

That the deed is in legal effect but a mortgage and a bill to redeem may be maintained without rescinding or cancelling it, is apparent from the following authorities :

- Holridge *v.* Gillespie, 2 Johns. Ch., 30, per Kent, J ;
- Shekel *v.* Hopkins, 2 Md. Ch., 90 ;
- Dougherty *v.* McColgan, 6 Gill & J., 275 ;
- Goodman *v.* Pledger, 14 Ala., 118 ;
- Perkins *v.* Drye, 3 Dana, 117 ;
- Villa v. Roderiguez*, 12 Wall. ;
- 2 Jones on Mortgages, § 1,046,

## II.

The Court is in error in stating that nine years and ten months elapsed prior to the entry of suit. The deed was executed November 4, 1881, and this suit entered September 16, 1890, a period of eight years and ten months ; deducting the four years of defendant's absence from the State, leaves a period of four years and ten months.

## III.

The Court erred in disregarding the State statute of limitations and in resorting to the doctrine of laches in its stead.

If the statute of limitations governs the case, the doctrine of laches has no application. In the case of *Norris v. Haggin*, 12 Sawyer, 51, 52, the Court held that the United States Courts sitting in equity were in duty bound to apply the State statute of limitations, and cited many cases to show that such is the law as declared by the national Supreme Court, and the case is the more pertinent in view of the fact that Sawyer, J., confessed that he was mistaken in asserting the law to be precisely what it is declared to be by this Court in the case which is the subject of this petition.

In support of our position that the State statute governs the case, in addition to the authority just cited, we refer the Court to the cases of *Cross v. Allen*, 141 U. S., 537 ; *Michoud v. Girod*, 4 How., 561 ; *Manning v. Hayden*, 5 Sawyer, 380. It would be strange indeed if this case would be governed by the State statute of limitations, and not by the doctrine of laches, if it had been instituted in the State Court, and conversely by the doctrine of laches and not the statute of limitations when entered in the Federal Courts. Such a conflict of law would tend very much to disturb the constitutional harmony of the two governments

and subject the rights of litigants to the disposition of two sets of laws, the one directly opposed to the other.

Nor do the cases cited by this Court in support of its views at all militate against our position. The case of *Twin Lick Oil Co. v. Marbury*, 91 U. S., 592, was determined upon a state of facts that excluded the possibility of a State statute of limitations. The case went to the Supreme Court from the *District of Columbia*, and the Court was not therefore in any respect concerned with the statute of limitations. The question of lapse of time had to be determined by the Court from "the inherent principles of its own system of jurisprudence, and to decide accordingly," for it had no other guide. Say the Court: "We are but little aided by the analogies of statutes of limitation"; that is, by statutes of limitation *generally*. If the case had originated in one of the States, where there was a statute of limitation applicable to the subject, the decision of the Court would clearly have enforced the prescription of the statute; but there being no such statute, the Court could not derive an analogy from "statutes (plural) of limitation" generally, and hence, of necessity, had to apply "the inherent principles of its own system of jurisprudence." Under no proper consideration of the case can the ruling in *Twin Lick Co. v. Marbury* be held applicable.

Nor is the case of *Sullivan v. Portland R. R. Co.*, 94 U. S., 811, an authority in support of the opinion and decision of this Court. The Court did not there



hold that the statute of limitations did not bind a United States Court sitting in equity, but it was held that the statute could not be considered as it had not been properly plead ; if that objection had not existed, it is very clear from the Court's opinion that the statute would have governed the case, and not the equity doctrine of laches. As there was no other guide, the Court was compelled to " apply the inherent principles of its own system of jurisprudence and to decide the case accordingly ;" a thing it would not have done had the statute of limitations been before the Court. This is the interpretation given the case in *Norris v. Haggin*, 12 Sawyer, 47, and is undoubtedly the correct one.

Applying, then, the State statute of limitation to the case, and giving full effect to the argument presented herein under our first ground for a re-hearing, the deed of November 4, 1881, must be held to be to all intents and purposes *a mortgage*, and turning to section three hundred and forty-six of the Code of Civil Procedure of California, we find a specific limitation in respect to the right to redeem from a mortgage, where the mortgagee is in possession, and that period is five years ; and again referring to section three hundred and fifty-one of the same Code, we find that " If, when the cause of action accrues against a person, he is out of the State, the action may be commenced within the term \* \* \* limited, after his return to the State, and if, after the cause of action accrues, he departs from

*the State, the time of his absence is not part of the time limited for the commencement of the action.”* (44 Cal., 280). And the Supreme Court of the State has held that successive absences are to be aggregated and then deducted from the statutory limitation (*Rogers v. Hatch*, 44 Cal., 280.)

Applying that law to this case, and deducting the four years of defendant's absence from the period that has elapsed intermediate the time of the execution of the deed and the commencement of this suit, and the result is, *four years and ten months*; which brings the case within the statutory period of five years (§ 346, C. C. P.), by two months.

As we have shown, the Court is bound to apply the limitation prescribed by the State statute, and that necessarily excludes the doctrine of laches. As pointed out in *Norris v. Haggin*, 12 Sawyer, 51, 52, the State statute applies to all cases both at law and in equity, and is obligatory on the Federal Courts of equity *proprio vigore* in cases of concurrent jurisdiction, and by analogy in cases of exclusive jurisdiction in equity. If the statute only applied to cases at law, then it could only apply by analogy to cases of concurrent jurisdiction in equity, but as it applies to cases in equity as well as at law, it is equally applicable by analogy to cases within the exclusive jurisdiction of Courts of equity (*Norris v. Haggin*, 12 Sawyer, 51, 52), sitting in the Federal jurisdiction.

It is quite clear, therefore, that the Court erred in

applying the doctrine of laches to the case ; for first, ten years, or any period short of twenty years, has never been held to bar the right to redeem ; and secondly, the statute of limitations alone governs the subject and establishes the plaintiff's right to maintain the suit, and the doctrine of laches does not pertain to the case or to any case where the statute of limitations governs either *proprio vigore* or by way of analogy. (*Cross v. Allen*, 141 U. S., 537.)

## IV.

The Court is in error in stating that "plaintiff's counsel attempts to distinguish between a right to regard the instrument as a mortgage and a right to regard it as a deed and to rescind it, admitting in the latter case that Section 343 of the Code of Civil Procedure controls and the plaintiff is guilty of laches." Plaintiff's counsel never at any time admitted that plaintiff was guilty of *laches*, but, on the contrary, strenuously opposed such a proposition at all times ; what counsel did concede was this : that if a *rescission* was necessary, Section 343 of the Code applied to the case ; but we have always contended and still maintain that, both upon principle and authority, no rescission is necessary or even proper ; that the deed is in legal effect but a mortgage—a constructive mortgage, 't is true—but a mortgage just as completely as though it had been so agreed by the parties. We will not repeat the discussion of this question here, but will refer the Court

to the points and authorities to be found under the first ground hereinbefore presented as one of the reasons why a re-hearing should be granted.

## V.

This Court had before it the opinion of the Circuit Court on the order sustaining the demurrer. That opinion is to be found in the brief of the appellee, and it indicates that the demurrer was not sustained on the ground of *laches*; if it had been, the appellant would have amended and shown satisfactory reason for the delay; as she was not cognizant of her rights until within a short period preceding litigation, and she then presented her objections to the State Courts in an action instituted against her by the appellee; but those objections were not passed on by the State Courts, and she thereupon instituted a suit on her own behalf in the Federal Courts. She relied on the opinion of the Circuit Court in electing not to amend, as she could not by amendment improve her case so as to meet the objection sustained by that Court, and she thereupon appealed for the purpose of securing redress, and now the appellate Court, instead of passing upon the ground on which the lower Court sustained the demurrer, entirely ignores it, and rules upon another and entirely different ground, that must be held to have been resolved in favor of the appellant by the Court below, and upon that basis affirms the judgment! We respectfully submit that this course is most unfair to a

litigant, and while we can readily appreciate that the reasoning of a Court is no part of its decision, yet the ground upon which it sustains a demurrer is of the very essence of the decision, and is wholly independent of the reasoning which led to its support ; and it seems to us that it is an exercise of original and not of appellate jurisdiction for a Court of review to affirm a judgment rendered on demurrer upon a ground which had been virtually ruled in favor of the appellant by the Court below—at all events, upon a ground of demurrer entirely different from that upon which the judgment was based by the Court which rendered it. The plaintiff has certainly been misled by the decision of the lower Court, if the appellate Court finally disposes of the case upon a ground essentially different from that on which it was decided in the Court below, and which might have been obviated by the plaintiff had it not been virtually ruled in her favor by the Circuit Court.

We respectfully submit that there is nothing in the bill to show that the defendant has been injured by the lapse of time, or that he is in any worse position now than he was the very next day after the transaction, and therefore, even if the doctrine of laches did control, it should not be applied in this case, since the mere lapse of time can never at law or in equity destroy a right, unless of course, it be found in a statute of limitations—an entirely different matter from laches. The burden is on the defendant to show that he has

been injured by the lapse of time, and there is no such showing in this case. Indeed it has been stated to be one of the maxims of Chancery that "Length of time no objection in Equity to redemption" (Barton's Digest of Legal Maxims, p. 284).

Above all, it must be laid down with emphasis that it is not only unnecessary but improper to rescind, or set aside, or cancel the deed of November 4, 1881, for under the authorities hereinbefore cited, in the eyes of the law, that instrument is constructively a *mortgage*. As was said in *Villa v. Roderiguez*, 12 Wallace, 323, *per Curia*, in respect to a similar instrument: "The law upon the subject of the *right to redeem where the mortgagor has conveyed to the mortgagee the equity of redemption* is characterized by a jealous and salutary policy \* \* \* *The form of the instrument is immaterial. That the mortgagor knowingly surrendered and never intended to reclaim, is of no consequence.*"

Thus this Court must perceive its error in disposing of the case upon the theory that the instrument of November 4, 1881, is a deed, and that it is necessary to rescind or cancel it before the plaintiff's right to redeem can become established, and that defendant had the right to know whether it was to stand as a deed or a mortgage. It never was a deed, and as the defendant was a party to the transaction, he must be held to have known *ab initio*, that the instrument was nothing more than a *mortgage*, from which the plaintiff had the right to redeem, and that by virtue of Section 346 of the Code of Civil Procedure of California, that right could

be exercised at any time before he acquired a title by adverse possession (*Hall v. Arnott*, 80 Cal., 355, 356).

The Court seems to overlook the fact that this is a *bill to redeem*, and therefore that no other limitation is applicable to the case than that pertaining to bills of redemption. Rescission, cancellation, annulment and revocation are all essentially foreign to the case, and a reference to either of them is not only erroneous but positively misleading.

We respectfully submit that upon principle and authority, and, upon the very justice of the case, the appellant is entitled to a re-hearing and she respectfully petitions the Court that such be its order.

FRANCISCA L. DE MARTIN,  
Petitioner.

GEORGE D. COLLINS,  
Counsel for Petitioner.

UNITED STATES OF AMERICA,  
Northern District of California. } ss.

This is to certify that I, George D. Collins, an attorney and counsellor of the United States Circuit Court of Appeals for the Ninth Circuit, and of the Supreme Court of the United States of America, have duly, carefully and diligently examined the foregoing petition for a re-hearing, and that I believe it to be well founded in point of law and of fact.

In Witness Whereof, I have hereunto set my hand.  
this 28th day of July, A. D. 1892.

GEORGE D. COLLINS,  
Counsel for Petitioner.





No. 28.

## TRANSCRIPT OF RECORD.

---

UNITED STATES CIRCUIT COURT OF APPEALS FOR THE NINTH CIRCUIT.

APRIL, TERM, 1892.

WM. H. LAKIN, PLAINTIFF IN ERROR,

*vs.*

J. H. ROBERTS, W. C. ROBERTS, M. KERR AND MRS. KERR. HIS WIFE,  
P. LAURENZI, JOHN DALY, P. TIVENON, M. ANTONOVICH, J. F.  
BACHER, JOHN WILLOUGHBY, JOHN NEVILL, JOHN KNIGHT, A.  
CURTIS, D. ROBINSON, H. B. HOUGHTON, J. F. HOUGHTON, JOHN  
THOMAS, JAS. MENZIES, GEO. WOODWARD, MRS. ANNA JENKINS,  
O. B. DOLLY AND MRS. DOLLY, HIS WIFE, M. A. PASSETTA, B. L.  
JONES, M. WILLOUGHBY, W. H. THOMAS, JOHN POWNING, SOL.  
BABB, MRS. BABB, HIS WIFE, GEO. HAKE, G. E. COOK, FRANK  
MEFFLEY, GEO. MAXWELL, ROBT. PENMAN, L. CIPRIOTTO, FRANK  
TUCKER, H. S. DUNN, WM. LITTECOTT, JOHN CREIGHTON, F. VAN-  
ZINI, EDWARD MITCHELL, WM. GALLAGHER, A. GRAZIER, H.  
PERIN, M. CURTIS, E. STEPHENS, JACK MONI, HENRY DONEY,  
AND L. GRONDONI, DEFENDANTS IN ERROR.

TRANSCRIPT ON WRIT OF ERROR.

TO THE U. S. CIRCUIT COURT, NORTHERN DISTRICT OF CALIFORNIA.

---

FILED

MAR 26 1892



# UNITED STATES CIRCUIT COURT OF APPEALS

FOR THE NINTH CIRCUIT.

---

WM. H. LAKIN, PLAINTIFF IN ERROR,

*vs.*

J. H. ROBERTS ET AL., DEFENDANTS IN ERROR.

---

## TRANSCRIPT ON WRIT OF ERROR.

TO THE U. S. CIRCUIT COURT, NORTHERN DISTRICT OF CALIFORNIA.

---

### INDEX.

	Original.	Print.
Answer .....	22	4
Assignment of Errors.....	86	42
Bill of Exceptions.....	43	13
Certificate of Judgment-Roll.....	42	13
Certificate of Record.....	94	45
Complaint.....	1	1
Findings.....	28	7
Judgment....	35	12
Opinion.....	69	32
Return to Writ of Error.....		47
Stipulation as to Printing.....		47
Writ of Error.....	95	46



1 In the Circuit Court of the United States, Ninth Circuit,  
Northern District of California.

WM. H. LAKIN, Plaintiff,

*vs.*

J. H. ROBERTS, W. C. ROBERTS, M. KERR and Mrs. KERR, his wife, P. LAURENZI, JOHN DALY, P. TIVENON, M. ANTUNOVICH, J. F. BACHER, JNO. WILLOUGHBY, JNO. NEVILL, JNO. KNIGHT, A. CURTIS, D. ROBINSON, S. SORACCO, R. TRAMALONI, H. B. HOUGHTON, J. F. HOUGHTON, JNO. THOMAS, JAS. MENZIES, GEO. WOODWARD, MRS. ANNA JENKINS, O. B. DOLLY and Mrs. DOLLY, his wife, M. A. PASSETTA, B. L. JONES, M. WILLOUGHBY, W. H. THOMAS, JNO. POWNING, A. TRAVEGA, SOL. BABB and Mrs. BABB, his wife, GEO. HAKE, G. E. COOK, FRANK MEFFLEY, GEO. MAXWELL, ROBT. PENMAN, L. CIPRIOTTO, HENRY DONEY, FRANK TUCKER, H. S. DUNN, WM. LITTECOTT, JNO. CREIGHTON, F. VANZINI, EDWARD MITCHELL, WM. GALLAGHER, A. GRAZIER, H. PERIN, M. CURTIS, E. STEPHENS, JACK MONIE, A. DALY, IRA DEARBURN, JOS. INGRAM, S. TRENGOVE, H. PASCOE, JOS. TIPPETT, A. PICKENS, RICH'D KEMP, L. GRONDONI, A. PEZZOLA, JOHN WEGAN, F. SOBRERO, B. FERNGARO, JOS. GIAMBRONE, CARLO PAGGI, BAPTISTO LEDONESIS, JOHN DALY, A. PASCU, C. CARLO, JOHN SOROCOCO, JNO. GRONDONI, PETER CUNIO, LOUIS PEZZALO, BERTO SALARI, JNO. CUNIO, NICHOLAS SALARI, JOHN DOE, RICHARD ROE, JOHN DENN, RICHARD DENN, JOHN FENN and RICHARD FENN, Defendants.

The plaintiff, Wm. H. Lakin, who is a citizen of the State of Ohio, and a resident of Clermont County, in said State, complains of the defendants above named, all of whom  
2 are citizens of the State of California, and residents of the County of Plumas, in said State, and for cause of action alleges:

1st. That plaintiff is, and since the 19th day of November, 1888, has been the owner, seized in fee, and entitled to the possession of the following described premises situated in the County of Plumas, and State of California, to-wit:

Beginning at a point N. 45 deg. 30 min. E. 2100 ft. distant from an iron pin set in a rock near the mouth of the "railroad" tunnel, Plumas Eureka Mine, said iron pin being the initial

point of the patent survey of the Eureka Quartz Mine (from which pin a hole drilled in a large rock bears N. 54 1-2 deg. E. 151, 8 ft. distant) (from said point of beginning an iron pin set in a large green stone rock bears N. 38 1-4 deg. W. 96.40 ft. distant) and running thence (1st) S. 44 1-2 deg. E. 1192.5 ft. to a post in rock mound from which an iron pin set in the top of a large green stone rock bears N. 87 1-2 deg. E. 80.5 ft. distant and post M. No. 2 of the Mammoth patented land bears S. 76 1-4 deg. W. 185.44 ft distant; thence (2nd) N. 76 1-4 deg. E. 1769 ft. to the northerly corner of Plumas Eureka Company's pressure box or tank on tail ditch from the "Mohawk" mill, from which post M. No. 3 of the Mammoth patented lands bears S. 36 1-2 deg. W. 156.5 ft. distant; thence (3rd) N. 87 deg. 47 min. E. 740 ft. to a post in rock mound 75 ft. northerly from the Plumas Eureka Company's Sulphuret works, 856 ft. to center of Jamison Creek; thence up the center of Jamison Creek as follows: (4th) S. 30 deg. E. 290 ft. (5th) S. 64 1-2 deg. W. 300 ft. (6th) S. 42 1-2 deg. W. 220 ft. (7th) S. 15 deg. W. 340 ft; thence across island. (8th) S. 55 deg. W. 480 ft. to intersection with the third course of the said Mammoth patented lands; thence on said third course. (9th) S. 9 deg. 57 min. E. 270 ft. to an iron pin set in a ledge of Hornblendic greenstone described in said Mammoth patent as an "iron pin set in a Basalt rock;" thence (10th) S. 64 deg. 53 min. W. 200 ft. to center of Jamison Creek; thence up the center of Jamison Creek (11th) S. 7 deg. E. 335 ft. to its intersection with the fifth course of the Mammoth patented lands; thence (12th) S. 80 deg. 45 min. E. 854 ft. to corner M. No. 5 of said Mammoth patented land, from which a cedar tree 24 inches in diameter bears S. 83 1-2 deg. E. 16 ft. distant, a cedar tree 24 inches in diameter bears S. 2 1-4 deg. E. 24.75 ft distant and a pitch pine 24 inches in diameter bears N. 83 1-2 deg. W. 64.5 ft. distant; thence (13th) N. 30 deg. 20 min. E. 4355 ft. to a pine stump 5 ft. in diameter M. No. 6 of said Mammoth patented lands; thence (14th) S. 88 deg. 20 min. W. crossing Jamison Creek 1395 ft. to post M. No. 7 of said Mammoth patented lands from which a pine tree 18 inches in diameter bears S. 46 1-2 deg. W. 23.3 ft. distant, the N. E. corner of the graveyard fence bears S. 53 deg. W. 29.70 ft distant, and the 1-4 section corner on South boundary of Sec. 12, T. 22 N., R. 11 E, Mt. Diablo Base and Meridian, bears N. 71 deg. 53 min. W. 320 ft. distant; thence

(15th) S. 69 deg. W. 2450 feet to post M. No. 8 of said Mammoth patented lands; thence (16th) N. 45 deg. 11 min. W. 842 ft. to corner M. No. 9 of said Mammoth patented lands from which a sugar pine stump 5 feet in diameter bears S. 46 1-2 deg. E. 30 ft. distant; thence (17th) N. 45 1-2 deg. E. 594 ft. to corner M. No. 10 of said Mammoth patented lands from which a pitch pine tree 36 inches in diameter bears N. 85 deg. 42 min. E. 168 ft. distant; thence (18th) N. 44 deg. 30 min. W. 214 ft. to a post in rock mound M. No. 11 of said Mammoth patented lands, from which the S. W. corner of Sec. 12, T. 22 N., R. 11 E., Mt. Diablo Base and Meridian bears S. 55 1-2 deg. W. 438.6 ft. distant; thence (19th) S. 45 deg. 30 min. W. 2288 ft. to a post in rock mound from which an iron pin set in a large green stone rock bears N. 31 1-2 deg. W. 47 ft. distant; thence (20th) S. 44 deg. 30 min. E. 50 ft. to the place of beginning.

2nd. That the defendants, and each of them, wholly disregarding the rights of said plaintiff, heretofore, to-wit: on the 19th day of November, 1888, wrongfully and unlawfully entered upon the said tract of land belonging to this plaintiff, and wrongfully and unlawfully ousted this plaintiff therefrom, and wrongfully and unlawfully withhold the possession thereof from this plaintiff.

3rd. That the plaintiff is ignorant of the true names of the defendants John Doe, Richard Doe, John Denn, Richard Denn, John Fenn and Richard Fenn, and therefore sues them by said fictitious names and plaintiff prays that when their true names are discovered this complaint may be amended by inserting the same.

4th. That the value of the premises so withheld by defendants from plaintiff, and in controversy in this action, exceeds the sum of five thousand dollars.

Wherefore plaintiff prays judgment that he recover the possession of said premises from the said defendants, and each of them, and have a writ of restitution therefor; and that he recover his costs herein expended.

5 Duly verified.

H. L. GEAR,

*Attorney for Plaintiff.*

Endorsed: Filed December 5th, 1889. L. S. B. Sawyer, clerk.

(Here follows pages 6 to 21 inclusive in original record which contain the summons and return of service which are omitted from the printed transcript pursuant to stipulation.)

*Answer.*

22

(Title of court and cause.)

Now come J. H. Roberts, W. C. Roberts, M. Kerr and Mrs. Kerr, his wife, P. Laurenzi, John Daly, P. Tivenon, M. Antonovich, J. F. Bacher, John Willoughby, John Nevill, John Knight, A. Curtis, D. Robinson, S. Sorocco, H. B. Houghton, J. F. Houghton, John Thomas, Jas. Menzies, Geo. Woodwood, Mrs. Anna Jenkins, O. B. Dolly and Mrs. Dolly, his wife, M. A. Passetta, B. L. Jones, M. Willoughby, W. H. Thomas, John Powning, Sol Babb and Mrs. Babb, his wife, Geo. Hake, G. E. Cook, Frank Meffley, Geo. Maxwell, Robt.

23 Penman, L. Cipriotto, Henery Doney, Frank Tucker, H. S. Dunn, Wm. Littecott, John Creighton, F. Vanzini, Edward Mitchell, Wm. Gallagher, A. Grazier, H. Perrin, M. Curtis, E. Stephens, Jack Moni, A. Daly, Ira Dearburn, Jas. Ingram, H. Pasco, Jas. Tippet, A. Pickens, Richard Kemp, Z. Grondoni and John Wegan, some of the defendants, and answering for themselves alone, deny:

1st. That plaintiff owns, or ever owned, or was ever seized of, or is, or ever was, entitled to the possession of the land described in the complaint, or any portion thereof.

2nd. That these defendants, or either or any of them, ever wrongfully or unlawfully entered upon said tract or ousted the plaintiff therefrom, or from any portion therefrom, or that they or either of them ever withheld the same or any portion of said land from plaintiff, save and except a small portion thereof occupied and described as the town of Johnsville, which town is particularly marked and designated by survey and plat on file with the Recorder of Plumas county as the Official Plat of said town, and except also, three certain lots on what is called Eureka Hill, west of said town, hereinafter more particularly described, all of which said excepted portions comprise about twenty-one acres of land and which are held by the defendants severally, each holding a separate and distinct lot or portion thereof, as hereinafter more particularly described.



Further answering defendants allege:

1st. That the town of Johnsville is situated on said tract of land; that it is a place of business and trade with a population of more than two hundred people, and having public buildings and a cemetery, and has been such for more  
24 than thirteen years last past; that the said town occupies about twenty acres of land and is laid off in streets, blocks and lots, and has been regularly surveyed, and an official plat of said survey is on file with the Recorder of Plumas county, California, showing the said streets, blocks and lots, and the extent and location of the same.

2nd. That most all of these defendants are residents of said town, and they and their several grantors have been such residents during the existence of said town, and they severally are, and for more than six years last past, they and their several grantors have been in the open, notorious, peaceable and exclusive possession and occupancy of certain lots, pieces and parcels of said town-site lands, that is to say: The defendant J. H. Roberts and his grantors of Lot two in Block nine; defendant W. C. Roberts and his grantors of Lot three in Block nine; defendant Kerr and his wife and their grantors of Lot four in Block nine; defendant Laurenzi and his grantors of Lot two in Block four and Lot five in Block nine; defendant John Daly and his grantors of Lot eight in Block nine; defendant Antonovich and his grantors of Lot one in Block ten; defendants Willoughby and their grantors of Lot five in Block five, Lot three in Block ten, and Lot three in Block fourteen; defendant Nevill and his grantors of Lot one in Block two, Lot three in Block seven, Lot two in Block ten, Lots one and two in Block eleven and Lot one in Block twelve; defendant Curtis and his grantors of Lot two in Block twelve; defendant Robinson and his grantors of Lot three in Block eleven; defendant Houghton and his grantors of Lot one in Block one, and Lot four in Block twelve;  
25 defendant John Thomas and his grantors of Lot one in Block eight; defendant Menzies and his grantors of Lot two in Block eight; defendant Woodward and his grantors of Lot two in Block seven; defendant Jenkins and his grantors of Lot one in Block seven; defendant Passetta and his grantors of Lot one in Block five, and Lot one in Block six; defendant Jones and his grantors of Lot one in Block four, and Lot three in Block six; defendant W. H. Thomas and his grantors of Lot three in Block four; defend-

ant Paesega and his grantors of Lot five in Block four; defendants Babb and their grantors of Lot two in Block one; defendant Hicks and his grantors of Lot three in Block one; defendant Cook and his grantors of Lot five in Block one; defendant Meffley and his grantors of Lot three in Block two; defendant Maxwell and his grantors of Lot four in Block two; defendant Cipriotto and his grantors of Lot four in Block three; defendant Doney and his grantors of Lot two in Block three; defendant Penman and his grantors of Lot five in Block two; defendant Tucker and his grantors of Lot one in Block three; defendant Dunn and his grantors of Lot two in Block two, and Lot three in Block three; defendant Liddcott and his grantors of Lot two in Block fourteen; defendant Creighton and his grantors of Lot four in Block fourteen; defendant Vanzini and his grantors of Lot one and two in Block eleven, Lot five in Block fourteen, and Lot one in Block twelve; and defendant Grazier and his grantors of Lots six and seven in Block nine, and Lot one in Block fourteen; as each and all of the aforesaid lots are described on the aforesaid official plat of said town. And during all of said time each of these defendants and their respective grantors have claimed title to the Lot so held by him and them respectively  
 26 adverse to all persons and particularly adverse to the plaintiff. And that such possession and occupancy was with the knowledge of plaintiff.

3rd. That the defendants Dearburn, Ingram and Pascoe now are, and for more than six years prior to the commencement of this action, they and their grantors have been severally in the open, notorious, quiet and peaceable possession and occupancy of three certain lots of land on Eureka Hill, immediately west of said town of Johnsville, and within the general tract described in plaintiff's complaint that is to say: The defendant Dearburn and his grantors of that certain lot known as and called the Dearburn dwelling house, lot about fifty feet square; the defendant Ingram and his grantors of that certain other lot generally known and called as the Ingram dwelling house, lot about fifty feet square; and the defendant Pascoe and his grantors of that certain other lot of land generally known as and called the Pasco dwelling house, lot about fifty feet square, each of them and their several grantors claiming title thereto during all of said time, adverse to all persons and particularly adverse to the plaintiff, and their said several possession and occupancy of said premises was with the knowledge of plaintiff.

4th. The defendants further allege that neither the plaintiff, his ancestor, predecessor nor grantor has been seized or possessed of either or any of the said lots in the town of Johnsville or on said Eureka Hill, or of any part or portion of either of the same within six years last past.

Wherefore defendants ask that this action as to them  
27 and to each of them be dismissed, and that they have judgment for their costs and disbursements in this behalf expended.

GOODWIN & GOODWIN,

*Attorneys for Defendants named.*

Duly verified.

Endorsed: Service of the within answer is hereby admitted this 20th day of March, 1890.

H. L. GEAR,

*Attorney for Plaintiff.*

Filed March 20, 1890. L. S. B. Sawyer, clerk.

*Findings.*

28

(Title of court and cause.)

This cause was submitted to the court upon documentary and other evidence stipulated between the plaintiff and such of the defendants as are represented by attorneys Goodwin & Goodwin; and the court having fully considered the same finds there from the following facts:—

1. That the lands described in the complaint are mineral lands, situated within the Jamison Quartz Mining District in Plumas County, State of California, and embrace the lands upon which the town of Johnsville is situated; that said lands have never been sectionized by the Government of the United States, nor in any manner surveyed by the Government other than as surveyed in the proceedings to obtain the patent hereinafter mentioned under which plaintiff claims title.

2. That said patent was issued to the Mammoth Gold Mining Company, a domestic corporation, on the 18th day of May 1877, and purports upon its face to be issued in pursuance of the Revised Statutes of the United States, upon an entry made by the said Mammoth Company, March 17th,

1877, but was in fact issued upon an application made by one John B. McGee and one James M. Thompson on August 30th 1867, under the law of Congress entitled "An act granting the right of way to ditch and canal owners over the public lands, and for other purposes," approved July 26th, 1866; that the patent embraces 4,100 ft. of a gold bearing quartz lode with 252.95 acres of surface ground; that the length along the lode embraces two locations, one the original Mammoth located in 1851, being 2100 feet, and the other the Extension, located in 1865, being 2000 feet in length, and in making said location no surface ground was claimed along the line of said lode; that the actual trend of the lode upon the said Extension is, and at the time of its location and at the time the patent issued was unknown, but the lode line as located in the original Mammoth and the Extension, and as marked upon the surface of the ground, and as fixed in the patent, is a straight line along the west or north west boundary of said patented tract and within fifty feet of said boundary line; and that the surface tract covered by the patent, except said fifty feet, is on the east or south-east side of said lode and extends about three-fourths of a mile therefrom.

3. That in 1851 the miners of said district adopted written laws governing the location of quartz claims therein, but such laws made no provision for the location of surface ground in connection with quartz claims in excess of one hundred feet on each side of the lode; nor was there at any time prior to 1868 any law, usage or custom in force in said district authorizing the location or occupancy of more than one hundred feet of surface ground on each side of the lode located; that the quartz miners of said Jamison District who opened and worked mines on Eureka Mountain therein, actually occupied such portion of the public land as they chose for the purpose of working their mines, the extent of such occupation however was not a matter of defined custom, but of actual possession; but there was no actual possession for mining purposes of the land on which the town of Johnsville is situated except the road leading across the same from the Mammoth mine to the Mammoth mill and to Jamison city; that it was the custom in force in said district from 1856 to 1868 to record all notices of mining locations in the office of the County Recorder of Plumas County, but no notice of the location or claim of the surface ground described in

said patent was ever so recorded until the patent was placed of record, and then only as contained therein.

4. That in 1867 said McGee and Thompson, then claiming to own both the Mammoth and the Extension, caused to be made a survey and diagram of the lode and exterior boundaries of the surface ground, and on the 30th day of August, 1867 they posted on said Mammoth claim the diagram and a notice as follows: "The undersigned give notice that they intend to apply for a patent for the vein or lode set forth in the above diagram called the Mammoth quartz claim, situated in the Jamison Mining District, County of Plumas, California, and now post this notice on a conspicuous part thereof. Dated on the ground this 30th day of August, 1867.

JOHN B. MCGEE,

JAMES M. THOMPSON."

That on the 7th day of September, 1867 they caused to be published in the Plumas *National*, a newspaper published in said County nearest said claim the following notice:

"The undersigned give notice that they intend to apply for a patent for the vein or lode known as the Mammoth quartz claim situated in the Jamison Mining District, County of Plumas, State of California, and now post this notice on a conspicuous part thereof; commencing at an iron pin drilled into a rock on the line dividing the Mammoth claim from the Eureka Claim and running thence for the center of the vein northeast 4,100 feet, and including the land between the lode and Jamison creek for working purposes. Dated on the ground this 30th day of August, 1867.

JOHN B. MCGEE,

JAMES M. THOMPSON."

That no notice than the one first above described was ever posted, and none published other than the one last described, in the proceedings to obtain said patent; that on the 11th day of Sept. 1867 said McGee and Thompson made and caused to be filed in the United States Land Office at Marysville, California, the office for the District in which said mine was situated, an application to purchase said quartz claim under the act of Congress aforesaid; and accompanied said application with the notice and diagram first above set forth;

that they caused the notice last above described to be published in the paper as aforesaid for the period of ninety days continuously from the said 7th day of Sept. 1867; and that they took no other or further steps to procure a patent for said claim; that subsequently their right to the 2,100 feet of the Mammoth claim, with all tunnels, mills and other mining appliances appurtenant thereto passed to the said Mammoth Gold Mining Company; that in March 1877 the said  
procured of the United States Surveyor General for California an adoption of the field notes of the survey which said McGee and Thompson had made in 1867 as aforesaid, as and for a final United States survey of the whole tract described in the patent, and took such other steps in the premises, without further notice or publication, as pro-  
32 cured the issuance of the patent therefor on the 18th day of May 1877 as heretofore found; that by mesne conveyances the rights of said Company passed to the Sierra Buttes Gold Mining Company; that the rights of said McGee and Thompson in and to the Extension to the Mammoth claim having passed to the plaintiff he commenced an action in this court against the said Sierra Buttes Gold Mining Company to enforce a trust against said Company in his favor as to said Extension, and thereafter, to wit: On the 19th day of November 1888 he obtained judgment in said action whereby and in pursuance of which there was conveyed to said Wm. H. Lakin, as part and parcel of said patented premises, the tract of land described in the complaint in this action.

5. That on the 17th day of June 1876 one John F. Banks entered upon and claimed twenty acres of land upon which the town of Johnsville is now situated and located the same for building and agricultural purposes; that notice of his claim thereto was recorded upon the records of Plumas County prior to the issuance of said patent; that buildings were erected on portions of his said tract during the summer and fall of that year; that the claim of Banks to this tract of land became vested in some of these defendants residing in said town; that by 1880 said town became and has since remained the center of trade and business for that section of country; that during all of said time the said town was laid off into streets, blocks and lots and had a population of over two hundred persons; and that no portion of said town is within one thousand feet of the lode as located and described in the patent.

6. That in 1883, for the first time, the said Sierra Buttes Gold Mining Company demanded of the citizens of Johnsville that they should pay a nominal rent to the Company for the land occupied by them as town lots; that the defendant  
33 Dolly and several other defendants paid from one to five dollars each at that time; that at no time prior to said date did any other person or company claiming to own the said land under said patent demand any rent of the citizens of said town, nor was any rents thereafter demanded until by this plaintiff in the spring of 1889; that those of defendants, if any, who entered upon the land subsequent to 1883, either obtained permission of said Sierra Buttes Company or entered upon the land within the limits of said town with the understanding that the said Company did not object to their occupancy so long as the enjoyment of its rights in the premises were not interfered with.

7. That the lands embraced in the patent were assessed for State and County purposes from 1878 to 1888, to the mining Company and it paid the taxes thereon; that after 1883 the defendants were assessed for taxes on their respective improvements on the land occupied by them, and the taxes so assessed were paid by them.

8. That in the spring of 1889 the plaintiff notified the defendants represented herein by attorneys Goodwin & Goodwin, to wit: Defendants J. H. and W. C. Roberts, M. Kerr and wife, P. Laurenzi, John Daly, P. Tivenon, M. Antonovich, J. F. Bacher, John Willoughby, John Nevill, John Knight, A. Curtis, D. Robinson, H. B. Houghton, J. F. Houghton, John Thomas, Jas. Menzies, George Woodward, Mrs. Anna Jenkins, O. B. Dolly and wife, M. A. Passetta, B. L. Jones, M. Willoughby, W. H. Thomas, John Powning, Sol Babb and wife, Geo. Hake, G. E. Cook, Frank Meffley, Geo. Maxwell, Robt. Penman, L. Cipriotto, Henry Doney, Frank Tucker, H. S. Dunn, William Littecott, John Creighton, F. Vanzini, Edward Mitchell, Wm. Gallagher, A. Grazier, H. Perin, M. Curtis, E. Stephens and J. Moni, that they must either pay rent for the land occupied by them, purchase said land, or quit the premises and move their improvements therefrom, within thirty days from such notice; that said defendants neglected and refused to perform either of  
34 said requirements and remained in possession of their several lots of land within said tract.

As conclusions of law from the foregoing facts the Court finds:

1st. That as to the land occupied by said defendants the said patent is void.

2nd. That at the time that this action was commenced the plaintiff did not own nor was he entitled to the possession of the land occupied by the defendants.

3rd. That as to the defendants herein above named this action be dismissed; and

4th. That they have judgment against the plaintiff for their costs and disbursements herein.

HAWLEY, *Judge*.

Endorsed: Filed October 31, 1891.

L. S. B. Sawyer, Clerk.

*Judgment.*

35

(Title of court and cause.)

This cause having been submitted to the Court, and the Court having filed its Findings of Fact and Conclusions of Law herein:

Now, in accordance therewith, it is by the Court ordered, adjudged and decreed that as to the defendants, J. H. & W. C. Roberts, M. Kerr and wife, P. Laurenzi, John Daly, P. Tivenon, M. Antonovich, J. F. Barker, John Willoughby, John Nevill, John Knight, A. Curtis, D. Robinson, H. B. Houghton, J. F. Houghton, John Thomas, James Menzies, Geo. Woodward, Mrs. Anna Jenkins, O. B. Dolly and wife, M. A. Passetta, B. L. Jones, M. Willoughby, W. H. Thomas, John Powning, Sol Babb and wife, Geo. Hake, G. E. Cook, Frank Meffley, Geo. Maxwell, Robt. Penman, L. Cipriotto, Henry Doney, Frank Tucker, H. S. Dunn, William Littercott, John Creighton, F. Vanzini, Edward Mitchell, William Gallagher, A. Grazier, H. Perin, M. Curtis, E. Stephens, J. Moni, L. Grondoni, the said action be dismissed and that they do have and recover of the plaintiff their costs and disbursements necessarily disbursed herein, taxed at — dollars.

Judgment entered this 31st day of October, 1891.

L. S. B. Sawyer, clerk.

[SEAL.]



A true copy. Attest.

L. S. B. SAWYER, *Clerk.*

Endorsed: Filed October 31, 1891.

L. S. B. Sawyer, clerk.

[Here follows pages 36 to 41 inclusive in original record containing additional findings and judgment on additional findings in favor of plaintiff against other parties, not parties to this writ of error, and which are omitted from this printed record pursuant to stipulation.]

*Certificate to Judgment-Roll.*

42

(Title of court and cause.)

I, L. S. B. Sawyer, Clerk of the Circuit Court of the United States, for the Ninth Judicial Circuit, Northern District of California, do hereby certify that the foregoing papers hereto annexed constitute the judgment-roll in the above entitled action.

Attest my hand and the seal of said Circuit Court this 31st day of October, 1891.

[SEAL.]

L. S. B. SAWYER, *Clerk.*

Endorsed: Judgment-roll filed October 31, 1891.

L. S. B. Sawyer, clerk.

*Bill of Exceptions.*

43

(Title of court and cause.)

Be it remembered that the above entitled cause was submitted to the Court upon facts, exhibits, documentary and other evidence stipulated between plaintiff and the defendants, represented by Messrs. Goodwin & Goodwin, pursuant to the following stipulation which was filed in said cause on the 28th day of April, 1890.

(Title of court and cause.)

“ It is stipulated that the controversy between plaintiff and  
“ defendants, represented by Goodwin & Goodwin, be sub-  
“ mitted for decision as far as respects said defendants and

“ each of them upon the following agreed statement of facts:

“ It is agreed that plaintiff holds whatever title to the  
 “ premises in controversy was acquired by the patent of the  
 “ United States to the Mammoth Gold Mining Company, a  
 “ certified copy of which patent is attached to and made part  
 “ of the complaint in the action of Wm. H. Lakin vs. The  
 “ Sierra Buttes Gold Mining Company, in the Circuit Court  
 “ of the United States, Ninth Circuit for the District of Cali-  
 “ fornia, No. 2693, which copy of said patent and the  
 44 “ judgment-roll in said action are hereby referred to and  
 “ made part of this agreed statement of facts; subject to  
 “ the objection of defendants that the said judgment-roll is not  
 “ competent proof as against the defendants except as a con-  
 “ veyance; that said patent and the portion of said patented  
 “ premises awarded by the judgment in said action to Wm.  
 “ H. Lakin includes the premises in controversy in this action.  
 “ It is further agreed that plaintiff's Exhibit No. 1 on file in  
 “ said action, which is hereby referred to, correctly shows all  
 “ the proceedings had upon the application for said patent and  
 “ is made part of this agreed statement of facts, subject to the  
 “ objections of plaintiff that it is not competent for defendant  
 “ to use any part thereof for the purpose of assailing the  
 “ validity of said patent. Said exhibit shows correctly all the  
 “ notice which was given of said application. It is further  
 “ agreed that any and all exhibits and testimony on file in said  
 “ action of Wm. H. Lakin vs. The Sierra Buttes Gold Min-  
 “ ing Company may be taken and considered as if offered in  
 “ evidence in this cause, subject to the objection that any par-  
 “ ticular exhibit or evidence used and referred to by either  
 “ party is irrelevant, immaterial and incompetent.

“ It is agreed that the lands in dispute are situated in the  
 “ Jamison Quartz Mining District in Plumas county, State of  
 “ California, and that defendants are to procure and file, as  
 “ an exhibit on their part, a written or printed copy of the  
 “ mining rules adopted in said District prior to 1867, authen-  
 “ ticated by affidavits taken *ex parte*, or may file *ex parte* affi-  
 “ davits showing their contents and date of adoption by  
 “ persons who will depose that they have seen such written or  
 “ printed rules and know their contents of their own knowl-  
 “ edge, and showing that said rules were lost or de-  
 45 “ stroyed, and when and how said loss or destruction  
 “ occurred, subject only to the objection of plaintiff  
 “ that any proof of said rules is irrelevant, immaterial and in-  
 “ competent, and that said affidavits do not conform to this

“agreement and that plaintiff may file counter affidavits as to  
 “the contents of said rules, subject to the same qualifications  
 “and objection as an exhibit on the part of plaintiff, if desired.

“It is further agreed that defendants are to procure and  
 “file, as an exhibit on their part, a certificate of the County  
 “Recorder of Plumas or Butte county, showing the character  
 “of all lode locations in said District prior to 1868 in respect  
 “to the number of feet along the lode claimed by each claim  
 “and the extent of surface or that no surface was claimed in  
 “the notice of location, said certificate to be taken as evidence  
 “of the custom of miners in said District, subject only to the  
 “objection that any proof of such custom is irrelevant, imma-  
 “terial and incompetent, it being further agreed that if plain-  
 “tiff desires to furnish a supplemental certificate of said Re-  
 “corder showing locations of lodes in said District prior to  
 “1868, not included in defendants' certificate, the same may  
 “be filed as plaintiff's exhibit.

“It is agreed that the town of Johnsville has now and for  
 “more than ten years last past has had a population of about  
 “two hundred persons; that during said time it has been laid  
 “out into streets and lots and used by said population as a  
 “trade or business center for the surrounding country; that  
 “a plat of said town was surveyed in the summer of 1889 by  
 “A. W. Keddie, and filed with the county recorder of Plumas  
 “county, and that a correct copy of said plat is attached to

46 “the answer in this cause; that the land occupied by  
 “said town is not within one thousand feet of the lode

“line, as described in the patent to plaintiff's grantor,  
 “and that the greater part thereof is not within two hundred  
 “feet of Jamison creek; that the said lode line of the 2,000  
 “feet extension of the Mammoth Ledge claimed by plaintiff,  
 “has never been opened or developed, and that the actual  
 “trend of said extension of the lode upon the patented ground  
 “is not known, but that developments in the working of the  
 “2,100 feet of the Mammoth Ledge still held and worked by  
 “the Sierra Buttes Company in a northeasterly direction to a  
 “point about 500 feet southwest from the southwest end of  
 “the said extension, indicate an actual trend of the lode,  
 “which, if continued in the same direction northeasterly  
 “through the plaintiff's part of the patented premises, would  
 “pass through the village of Johnsville, this latter fact being,  
 “however, agreed to subject to the objection of defendants  
 “that it is irrelevant, immaterial and incompetent.

“It is further agreed that the land described in the com-

“plaint, and upon which the said town is situated, has never  
 “been sectionized by the Government of the United States  
 “nor in any manner surveyed by the Government other than  
 “by the survey made in proceedings to obtain the patent to  
 “the Mammoth Quartz Mine, under which plaintiff claims  
 “title, and is mineral land.

“It is further agreed (subject to the objection of plaintiff  
 “that the facts are irrelevant, immaterial and incompetent to  
 “be received as evidence) that there was but one notice of  
 “location of the 2,000 feet extension of the Mammoth Ledge,  
 “which is the notice dated November 4, 1865, and filed as  
 “one of the exhibits above referred to in the case of Lakin  
 “vs. The Sierra Buttes Gold Mining Company, and  
 47 “that no definite claim of surface was made in connec-  
 “tion with said location until a survey was made, upon  
 “which the application for a patent is based, and that no loca-  
 “tion of surface was recorded upon the records of Plumas  
 “county prior to said patent.

“It is further agreed that one John Banks entered upon a  
 “portion of said premises at the date of the record of the  
 “claim or claims made by him and recorded upon the records  
 “of Plumas county, a duly certified copy of which claim or  
 “claims is to be procured by defendants and filed as an ex-  
 “hibit on the part of defendants in this action, subject to the  
 “objection of plaintiff that the same is irrelevant, immaterial  
 “and incompetent, and that thereafter the claim or claims of  
 “said Banks passed by mesne conveyances to a portion of  
 “said defendants; certified copies of which mesne convey-  
 “ances are to be procured by defendants and filed as an ex-  
 “hibit for defendants, subject to the same objection. It is  
 “further agreed that subsequent to the date of said patent  
 “the defendants, A. Curtis, Joseph H. Fletcher, D. Robinson,  
 “M. Willoughby, John Willoughby, O. B. Dolly, H. S. Dunn,  
 “J. H. Bacher, John Daly, S. Soracco, A. Grazier, Mrs. M.  
 “Kerr, and the grantors of defendants, B. F. Jones, successor  
 “to Joseph H. Fletcher, Antonovich, M. A. Passetta and  
 “John Neville, paid a small sum as rent to the Sierra Buttes  
 “Gold Mining Company for the privilege of occupying said  
 “premises, to wit, in the year 1883; that the remainder of  
 “said defendants entered upon the premises occupied by  
 “them upon said patented land since the year 1883, some of  
 “them with the express permission of said Sierra Buttes  
 “Company, and the remainder who did not ask permission,

48 “ entered with the understanding that said Sierra Buttes  
 “ Company did not object to occupation of village lots,  
 “ provided its use and enjoyment of the patented prem-  
 “ ises was not interfered with.

“ That said patent was issued to the Mammoth Gold Min-  
 “ ing Company, May 18, 1877; that said patented premises  
 “ were conveyed by said patentee to the Plumas Eureka Min-  
 “ ing Company, December 11, 1877, and by said Plumas  
 “ Eureka Mining Company to the Sierra Buttes Mining Com-  
 “ pany, December 26, 1877; that the whole of said patented  
 “ premises were assessed for taxes each year from 1878 to 1888  
 “ inclusive to the said Sierra Buttes Gold Mining Company,  
 “ which paid all taxes assessed upon said land for each of said  
 “ years; that said defendants were assessed for each year  
 “ since 1883, only upon the improvements listed by them  
 “ upon the portion of said patented premises occupied by  
 “ them, said assessments describing said improvements, as set  
 “ forth in a certificate of the County Recorder of Plumas  
 “ county, to be procured and filed in this action by defendants  
 “ as exhibit, showing the description contained in said assess-  
 “ ments for each of said years; and that said defendants paid  
 “ the taxes so assessed to them for each of said years.

“ That in the spring of 1889 the plaintiff, after he had ac-  
 “ quired his said judgment against the Sierra Buttes Gold  
 “ Mining Company, enforcing a trust in the portion of said  
 “ patented premises, which includes the premises in contro-  
 “ versy, notified the defendants that they must either pay rent  
 “ to plaintiff for the portion of said land occupied by them, or  
 “ purchase said land, or quit the said premises and remove their  
 “ improvements therefrom within thirty days from the date of  
 “ said notice; but that said defendants neglected and refused  
 “ to do either of said requirements, and still remain in posses-  
 “ sion of the premises described in their answer.

49 “ It is agreed that quartz miners of Jamison District,  
 “ who opened and worked mines on Eureka Mountain,  
 “ actually occupied such portion of public land as they chose  
 “ for the purpose of working their mines, the extent of such  
 “ occupation not being a matter of defined custom, but of  
 “ actual possession; but that there was no actual possession  
 “ of the land on which the village of Johnsville is situated, ex-  
 “ cept the road leading across the same from the Mammoth  
 “ Mine to the Mammoth Mill and to Jamison City. The fore-  
 “ going facts being objected to by defendants as irrelevant,  
 “ immaterial and incompetent.

“ It is agreed that all the exhibits filed in the case of Wm. H. Lakin vs. O. B. Dolly, on the motion of plaintiff to vacate the verdict and judgment and to grant a new trial in that case, shall be taken and considered as if filed in this case, and that only such exhibits as are peculiar to the defendants in this case need be filed herein, and that all the provisions of the agreement in said case in respect to time of filing exhibits are applicable to this case.

“ It is further agreed that this cause shall be brought on for hearing upon this submission by either party after all exhibits shall have been filed ten days after service of notice of said hearing; but that there shall be no oral argument upon said hearing unless both parties are present, but the final submission, in the absence of either party, shall be upon briefs to be filed by the parties within such time as may be agreed upon or allowed by the Court; and that the time for the hearing of both causes shall be fixed upon the same day.

“ Dated April 28, 1890.

“ H. L. GEAR,

“ *Attorney for Plaintiff.*

“ GOODWIN & GOODWIN,

“ *Attorneys for Defendants represented by them.*”

50 The record, exhibits and documentary and other evidence appearing in the case of Wm. H. Lakin vs. The Sierra Buttes Mining Company, referred to in the foregoing agreed statement of facts, shows in substance that in July, A. D., 1851, an association of persons, composing what was called the Mammoth Company, located 2,100 feet of a quartz ledge on Eureka Mountain in Jamison Mining District, Plumas county, California, claiming that portion of the ledge, with all of its dips, spurs and angles, but not specifying any claim of surface adjacent to the ledge; that at the time of said location, the Company located and recorded in their records a claim of a tract of land on Jamison creek, which flows in a valley at the westerly base of the mountain, claiming three hundred yards on each side of Jamison creek, and eight hundred yards in length along the creek for mill privileges and for the timber it contained for the purpose of working the mine, and thereafter built a mill on this tract, between the ledge and the creek, run tunnels on the westerly slope of the

mountain and constructed a wagon road and tramway extending from the tunnels to the mill, across what is now the site of the village of Johnsville, which lies between the old mill and the lode line, and is situated on a flat at the base of the mountain, the site of the present village beginning about 1,000 feet easterly from the Mammoth lode line, and extending about 700 feet in width toward Jamison creek to a line about 200 feet distant therefrom.

That on November 4, 1865, the then owners of the original Mammoth claim, James M. Thompson and John B. McGee, with eight other persons, under whom they afterwards claimed title, located a northeasterly extension of 2,000 feet of said Mammoth lode, with its dips, spurs and angles, but did not specify in their notice of location any additional claim of surface ground. The actual direction of said extension of said lode was obscured, and was not known at the time of said location, or at any time thereafter, farther than as has been indicated by the workings in the original Mammoth ledge, and the general direction of the foot wall rock.

That on the 26th of August, 1867, said Thompson and McGee procured one D. D. Brown, a United States Deputy Mineral Surveyor to make for them a survey of said 4,100 feet of lode line and 252 and 95-100 acres of surface ground, including a strip of ground 50 feet northwest of the lode line as located, and a tract of land lying southerly and easterly therefrom, extending to and across Jamison creek, and also including the original Mammoth Mill site claim on both sides of the creek. The said survey included the whole of the present site of Johnsville, no part of the village being then in existence, and included all of the land in controversy in this action. Said surveyor located and marked monuments upon the land surveyed for the boundaries thereof, and said survey was made as the basis of an application for a patent for said land, by said Thompson and McGee, and was afterwards approved by the surveyor-general, as the final survey of said land for which a patent was issued for the whole of the land so surveyed.

That on the 30th day of August, 1867, said Thompson and McGee posted in a conspicuous place on said land, a diagram of said survey, attached to a notice bearing that date and stating "that they intend to apply for a patent for the vein or lode set forth in the above diagram called the Mammoth quartz claim, situated in the Jamison Mining District,

“County of Plumas, California, and now post this notice in a  
“conspicuous part thereof.”

52 That on the 7th day of September, 1867, said McGee and Thompson caused to be published in the *Plumas National*, a weekly newspaper, published in said County of Plumas, the following notice:

“The undersigned give notice that they intend to apply  
“for a patent for the vein or lode known as the Mammoth  
“quartz claim, situated in the Jamison Mining District,  
“County of Plumas, State of California, and now post this  
“notice on a conspicuous part thereof; commencing at an  
“iron pin drilled into a rock on the line dividing the Mam-  
“moth claim from the Eureka claim, and running thence for  
“the center of the vein northeast 4,100 feet, and including  
“the land between the lode and Jamison Creek for working  
“purposes.

“Dated on the ground this 30th day of August, 1867.

“

JOHN B. MCGEE.

“

JAMES M. THOMPSON.”

And they caused such publication to continue for ninety days thereafter.

Exhibit No. 1, on file in the action of Wm. H. Lakin vs. The Sierra Buttes Gold Mining Company, referred to in the agreed statement of facts in this cause, is an exemplified copy of all the proceedings had in the Land Department of the United States, upon which was based the patent under which plaintiff claims title to the premises in controversy, and it appears from said Exhibit No. 1 that on the 11th day of Sep-

53 tember, 1867, said Thompson and McGee made application to the Land Office at Marysville for a patent for the lode and land included in said diagram of survey under the Act of Congress of July 26, 1866, alleging that they were the present owners of the Mammoth quartz claim in the Jamison Mining District, County of Plumas, and State of California, and that as an association of persons they had theretofore occupied and improved the same in accordance with the local customs and rules of the mines in said District, and had expended in actual labor and improvements thereon an amount not less than one thousand dollars, that there was no controversy within the petitioner's knowledge as to said claim; and further alleging that they therewith presented a diagram of said mining claim so extended as to conform to



the rules of said mining district, and making other allegations as required by said Act of Congress, and requesting in said application that the Register of the Land Office for the Marysville District do publish according to said Act, a notice of their intention to apply for a patent in the *Plumas National*, a paper published at Quincy, in the County of Plumas, California, being a paper published nearest the location of said claim; and that on said 11th day of September, 1867, the Register of said Land Office made an order that the notice of said intention to apply for a patent be published for ninety days in said *Plumas National*.

Said Exhibit No. 1 further shows that on the 27th day of February, 1877, the Register of said Land Office certified to said surveyor-general, "in relation to the application No. 27 of J. B. McGee and James M. Thompson for patent to Mammoth Mining Claim, situated in Plumas County, California," "that the records and files of this office show that the above application No. 27 for a patent to said mining claim, together with a copy of the diagram and notice thereof, were filed in this office on the 11th day of September, 1867; that on the same day the copy of said notice and diagram were duly posted in this office, and remained so posted for the period of ninety consecutive days; that said notice and diagram were duly posted on said claim on the 30th day of August, 1867, and remained so posted for ninety consecutive days; that upon the order of the Register of this office, a copy of said notice was duly published in the *Plumas National* for said period of ninety days, the same being a newspaper published at Quincy in Plumas County, State aforesaid; that no claim exists against the United States Government for the cost of said publication, all claims therefor having been waived by an agreement duly filed with such application;" and "that no adverse claim to any portion of said mining claim has been filed in this office."

Said Exhibit No. 1 further shows that on the 2nd day of March, 1877, said Surveyor-General returned to said Land Office his first survey of the premises applied for, that which was designated by said Surveyor-General as Lot No. 44, and which certified to the said Land Office that the attached field notes of the preliminary survey of the mining claim, known as the Mammoth Quartz Mine, claimed by John B. McGee and James M. Thompson, executed by D. D. Brown, U. S. Deputy Mineral Surveyor, in the month of August, 1867, were adopted as the final survey of said premises; that the

field notes and report of said preliminary survey of said D. D. Brown, attached to said certificate of said surveyor-general, certified that on the 28th day of August, 1867, there were three tunnels on the claim, designated as the "upper," "middle" and "lower;" that there was a mill for reducing the rock on Jamison Creek, worked by water in a ditch taken from the creek, and that there was plenty of timber near the mill for all purposes; that said Exhibit No. 1 further shows that

55 on the 2nd day of March, 1877, the Mammoth Gold Mining Company, by Wm. Letts Oliver, its secretary, filed in said Land Office an affidavit of said Wm. Letts Oliver, stating in substance that said Company became the purchaser of said Mammoth Quartz Lode, June 7, 1870, and went into possession of the same and of all the surface ground included in the application of said Thompson and McGee for a patent, and have remained in the continuous occupancy and possession thereof from that date and had caused tunnels to be run and valuable improvements erected at an expenditure of not less than \$50,000. Said Exhibit No. 1 further shows that on the 3rd day of March, 1877, one R. M. Wilson filed in said Land Office an affidavit taken before the Register of the Land Office, who certified that said affiant was a credible and respectable person, which affidavit stated that the affiant was a Deputy Mineral Surveyor for the State of California, and within the line of his official duties had within the last twelve months, prior to said date, made diligent search and inquiry in the old Jamison Mining District, Plumas County, California, for missing records and mining rules and regulations for that District, but was unable to find any and that he believed that neither records or mining rules or regulations existed there at that time, and further believed that none had been in existence in said District for many years; that everything relating to mines or mining claims, that have become a matter of record since 1870, has been recorded in the County Recorder's office for said County of Plumas. Said Exhibit No. 1 further shows that there were filed in said Land Office by said Mammoth Gold Mining Company certain conveyances

56 in support of its claim of title to said Mammoth Mine as the successor in interest of said Thompson and McGee, a copy of its certificate of incorporation, and an abstract of the records of Plumas County certified by the County Clerk, showing the state of said records, as affecting the title to said mine, and that there was no pending litigation concerning it; and that on the 17th day of March, 1877, said

Mammoth Gold Mining Company, a corporation, was allowed to purchase and enter said "Lot No. 44," and that on that date the following certificate of entry was made and issued to said Mammoth Gold Mining Company.

“REGISTER’S FINAL CERTIFICATE OF ENTRY.

“Mineral Entry }  
 “ No. 62 } U. S. Land Office at Marysville, Cal.  
 “ Lot No. 44. } 17th March, 1877.

“It is hereby certified that in pursuance of the Mining Act of Congress, approved July 26, 1866, the Mammoth Gold Mining Company, (a corporation) (assignee or successor in interest of John B. McGee and James M. Thompson), whose postoffice address is San Francisco, California, on this day purchased that mineral claim or lot of land of Section in Township No. 22, North of Range 11 E. Mt. Diablo Base and Meridian, situate, lying and being in the Jamison Mining District, in the County of Plumas and the State of California, known as Mammoth Quartz Mining Claim, embracing 4.100 linear feet of the Mammoth Quartz Mining Claim, vein or lode, with 252 and 95-100 acres of surface ground, as shown by said survey, for which the said Mammoth Gold Mining Company has this day made payment to the Receiver in full, amounting to the sum of Twelve Hundred and Sixty-five (\$1,265) Dollars. Now, therefore be it known, that upon presentation of this  
 57 “certificate to the Commissioner of the General Land Office, together with the plat, survey and description of said claim, a patent shall issue thereupon, if all be found “regular.”

“ CHAS. M. PATTERSON, *Register.*”

The patent referred to in said agreed statement of facts recites that “In pursuance of the provisions of the Revised Statutes of the United States, Chapter Six, Title Thirty-two, there have been deposited in the General Land Office of the United States the plat and field notes of survey of the claim of the Mammoth Gold Mining Company upon the Mammoth Quartz Mine, accompanied by the certificate of the Register of the Land Office at Marysville in the State of California. whereby it appears that in pursuance of said

“ Revised Statutes of the United States, the Mammoth Gold Mining Company did, on the seventeenth day of March, A. D. 1877, enter and pay for said mining claim or premises, being mineral entry No. 62, in the series of said office designated by the Surveyor General as Lot No. 44,” giving the contents and metes and bounds of said survey in full; and purports “ In consideration of the premises, and in conformity with the said Revised Statutes of the United States.” to grant to said Mammoth Gold Mining Company and to their successors and assigns the said mining premises hereinbefore described in Lot No. 44, etc., including 4,100 feet of the said Mammoth Quartz Mine, vein, lode, ledge or deposit, and also “ of all other veins, lodes, ledges or deposits, throughout their entire depth, the tops or apexes of which lie inside the exterior lines of said survey.”

58 All of the title of said Mammoth Company in said patented premises passed by mesne conveyances to the Sierra Buttes Gold Mining Company, and it appears from the judgment roll in the said action referred to in said agreed statement of facts, that the title of the plaintiff to the premises claimed by him was obtained through the enforcement of a trust by said plaintiff Wm. H. Lakin, against said Sierra Buttes Gold Mining Company, in said action by the judgment of this court rendered therein on the 19th day of November, 1888, whereby and in pursuance of which there was set off and conveyed to said Wm. H. Lakin, as part and parcel of said patented premises the land and premises described in the complaint in this action.

Pursuant to said stipulation the defendants filed as exhibits to be used in this action on their part the affidavits of John S. Graham, J. D. Byers, Geo. Woodward, Sol Babb, John P. Hills, and A. Jump, each stating in substance that the original mining rules adopted by the miners of Jamison Mining District, were destroyed by fire in the year 1862; that rules in writing for said District were adopted at a meeting of miners in 1851, and that the affiant was familiar with said rules. The affidavit of John S. Graham states that the rules originally authorized each person to locate not to exceed 30 feet on a quartz ledge or lode, and not to exceed 250 feet on each side of said 30 feet of ledge located, and that the rules were subsequently changed so as to limit the location of a quartz claim to twenty feet along the ledge including the dips, spurs, and angles. The affidavit of J. D. Byers states that the size of quartz claims required by the laws adopted

in 1851 was twenty feet to each man along the course of the ledge including the dips, spurs, and angles; that he could not remember the exact amount of surface ground  
59 authorized to be located on each side of a lode claim, but is certain it did not exceed 100 feet on each side of the lode or vein located. The affidavit of Geo. Woodward states that said written rules adopted in 1851, authorized each person to locate not to exceed thirty feet along the line of the lode or ledge, with all of the dips, spurs and angles of the ledge, and to hold surface ground on each side of the ledge or vein not to exceed one hundred feet. The affidavit of Sol Babb states that the rules originally authorized each person to locate not to exceed thirty feet on a quartz ledge or lode, and not to exceed one hundred feet on each side of said thirty feet of ledge located, and were subsequently changed so as to limit the locator of a quartz claim to twenty feet along the ledge, including the dips, spurs and angles. The affidavit of John P. Hills states that said written laws originally authorized each person to locate twenty feet along the lode or vein; that he did not remember definitely the amount of surface ground on each side of the lode which each claimant could hold, but is certain that the rules did not authorize the location of more than one hundred feet on each side of the ledge, and knows of no change authorizing any greater amount of surface ground. The affidavit of A. Jump states that in 1851 and 1852 he had in his possession a copy of the local rules and records of Jamison Mining District, and became well acquainted with them, and the said rules authorized each miner to locate not to exceed 20 feet on a quartz ledge or lode including the dips and angles thereof. This last affidavit appears to have been prepared in blank by some other person before the filling up of the same and signature thereof by said Alembury Jump, and the following words are erased therefrom "and not to exceed      feet on each side of said feet of ledge so located." The plaintiff filed as counter-exhibits on his part the affidavits of James M. Thompson,  
60 John B. McGee, John McBeth, M. D. Howell, J. M. Miller and C. W. Bush, each stating in substance that the affiant was familiar with the laws adopted by the miners of Jamison Mining District in 1851, and that the same contained no provision in regard to the amount of surface ground which might be occupied by the locator of a quartz ledge; that such locators were allowed to occupy and use any surface not previously occupied by others for the purpose of working

their claims, and that gravel claims only were limited by said laws to 100 feet in breadth of surface; and that the laws adopted were disregarded shortly after their passage. The affidavits of James M. Thompson, John B. McGee, and John McBeth further state that the owners of quartz mines in the vicinity of the Mammoth, as well as the Mammoth Company occupied surface for working purposes for a distance of more than 1,000 feet from the vein. The affidavit of James M. Thompson further states that at the time of the location of the Mammoth Extension of 2,000 feet in 1865 he made diligent inquiry as to the existence of miner's rules in said District at that time, and then ascertained that the old laws had been disregarded and that no laws relating to the location of quartz or placer claims in said District were then in existence. The affidavit of John McBeth further states that he was one of the locators of the original Mammoth Quartz Claim; that the Eureka claim was first located 30 feet to the man along the vein; that the Seventy Six Company then passed laws limiting the claim to 20 feet along the vein, but the Mammoth Company was subsequently located and claimed 30 feet to the man, and the provisions of the laws as to the length of vein were not enforced after 1852. The affidavits of C. W. Bush and J. M. Miller further state that they were members of the Eureka Company which was the first quartz claim located in Jamison Mining District and were locators of said claim in 1851, which claimed 30  
61 feet of vein to each locator; that the Seventy Six Company was afterwards formed and subsequently the Mammoth; that the Seventy Six Company claimed that the Eureka Company had taken up too much vein, and attempted to pass laws in which the Eureka Company took no part, making a quartz claim 20 feet in length along the vein; that the Eureka Company never acknowledged the laws adopted by the Seventy Six Company and they soon became a dead letter.

Pursuant to said stipulation, defendants filed as an exhibit on their part, a certified abstract of all lode locations made in Jamison Mining District, and recorded upon the records of Plumas County prior to 1868, as evidence of the custom of miners in said District as to extent of vein and surface claimed by locators of ledges therein; and that said exhibit shows that in the year 1856 two locations were recorded, one by three persons claiming 125 feet of the lode with its dips, spurs and angles, without mention of surface,

and the other by five persons claiming 275 feet "embracing all the dips and angles of the ledges together with surface ground necessary to work the ledge." In 1859 eight locations were recorded, the first four making no mention of surface ground and claiming 100 feet of ledge to each locator along the ledge, with its dips, spurs and angles. The other four were locations of 200 feet of ledge to each locator with one claim for discovery, claiming the ledge with all its dips, spurs, angles and branches to the width of 500 feet. In 1860 eight locations were recorded, one by fourteen claimants of 3,000 feet of ledge without mention of surface ground, the other seven being at the rate of 100 feet of vein to each locator, including all dips, spurs and angles of the ledge, four of them making no mention of surface, two others calling for "sufficient ground on either side for fully developing 62 and working the same," one other containing the words "together with all necessary appurtenances thereto for working and developing the ledge," one calling simply for "appurtenances" and the remaining one of the eight containing the words "together with all appurtenances necessary for developing the ledge." In 1862 three locations were recorded, two of them by locators claiming at the rate of 100 feet each, and the third by eleven locators claiming 2,500 ft. of ledge, all three locations claiming all dips and angles of the ledge without mention of surface ground. In 1863 two locations were recorded, one by seven locators claiming 100 feet and all quartz lodes within 125 feet of the ledge "and "sufficient ground upon each side thereof for the convenience "of working the same;" and one by thirty locators of 3,000 feet of ledge and all quartz veins within 125 feet, "also all "the land, wood and water within twenty rods of the said "ledge." In 1864 one location was recorded by fifteen persons of 2,000 feet of ledge, "with all dips, spurs and angles of the same" with no mention of surface ground. In 1865 six locations were recorded, three of them making no reference to surface ground, two claiming 200 feet, and one claiming 100 feet on each side of the ledge. Two of them claimed 100 feet of vein to each locator, and the other four claimed 200 feet of vein to each locator, one of these being the Mammoth Extension claim of 2,000 feet located by James M. Thompson, John B. McGee and eight others. In 1866 two locations were recorded, one by five locators claiming 1,200 feet of ledge, with all its dips, spurs and angles, without mention of surface ground, and the other by six

locators claiming 200 feet each, with 150 feet of ground on each side of the ledge.

Pursuant to said stipulation the defendants filed as  
63 an exhibit a certified copy of the recorded claim of John Banks, which shows that on the 20th of June, 1876, said John Banks recorded upon the records of Plumas County a notice of a claim of twenty acres of land "for building and "agricultural purposes" and described as follows: "Com-  
"mencing at a certain spruce tree situated on the west bank  
"of Jamison Creek on the N. E. line of the Mammoth Mill  
"ground, thence along said line in a N. W. direction to the  
"base of the mountain; thence in a N. E. course along the  
"base of the mountain ninety yards; thence in a S. E. course  
"by a large cedar and a dead pine tree to the brow of said  
"flat; thence up the brow of said flat to the place of begin-  
"ning." The defendants filed no exhibits showing any conveyance from said John Banks to any person, and filed no exhibit or exhibits on their part showing the mode in which taxes on improvements were assessed to the defendants.

This bill of exceptions incorporates the substance of all exhibits, documents and evidence referred to in said agreed statement of facts in said stipulation, and said stipulation was complied with as to the time and manner of filing exhibits except as above stated, and as to the submission of said cause.

Upon the hearing and consideration of said cause the Court over-ruled the objection of plaintiff that any proof of the mining rules of Jamison Mining District adopted prior to 1867 was irrelevant, immaterial and incompetent, and admitted and considered evidence of said rules in the decision of said cause, to which ruling plaintiff duly excepted.

The Court also over-ruled the objection of plaintiff that  
any proof of the custom of miners in said district was  
64 irrelevant, immaterial and incompetent, and admitted  
and considered evidence of said customs in the decision of said cause, to which ruling plaintiff duly excepted.

The Court also over-ruled the objections of plaintiff to the certified copy of the claim of John Banks, that the same was irrelevant, incompetent and immaterial, and admitted and considered evidence of said claim in the decision of said cause, to which ruling plaintiff duly excepted.

The Court filed its findings of fact and rendered judgment herein on the 31st day of October, 1891, and plaintiff served a draft of his proposed bill of exceptions on Goodwin and



Goodwin, attorneys for said defendants by mail on the 7th day of November 1891.

The plaintiff specifies and assigns the following errors of law committed by the Court in the trial and decision of said cause.

1st. The Court erred in over-ruling the objection of plaintiff to proof of the mining rules of Jamison Mining District.

2nd. The Court erred in over-ruling the objection of plaintiff to proof of the custom of miners in said District.

3rd. The Court erred in over-ruling the objection of plaintiff to proof of the claim of John Banks.

4th. The decision of the Court is against law in allowing the patent under which plaintiff claims title to be assailed by the defendants in this action.

5th. The decision of the Court is against law in holding that said patent is void as to any of the land occupied by the defendants, or as to any part of the premises therein described.

6th. The decision of the Court is against law in hold-  
65 ing that at the time this action was commenced plaintiff did not own, or was not entitled to the possession of the land occupied by the defendants.

7th. The decision of the Court is against law in deciding that as to any of the said defendants the said action should be dismissed, and in awarding judgment to any of them for their costs and disbursements.

Plaintiff also specifies the following particulars wherein the evidence is insufficient to justify the decision of the Court.

1st. Neither the evidence nor the agreed statement of facts justifies the finding or decision by the Court "that there " was not at any time prior to 1868 any law, usage or custom " in force in Jamison Mining District authorizing the location " or occupancy of more than 100 feet of surface ground on " each side of the lode located," but the evidence and the agreed statement of facts show the contrary facts to be true, and conclusively show that Thompson and McGee at the time of their application for a patent in 1867 had theretofore occupied and improved the premises applied for in accordance with the local customs and rules of the miners in said District; and that there was then no controversy as to their claim to the whole of said premises; and that there was then no

mining rule or custom in force precluding their occupancy of the whole thereof or their application for a patent for the whole of said premises or the granting of a patent for the same.

2nd. Neither the evidence nor the agreed statement  
66 of facts justifies the finding or decision of the Court that "no surface ground was claimed along the line of " said Mammoth lode" or the implied finding or decision that no surface ground parallel to said lode was claimed by the locators thereof; but they show on the contrary that the locators of said Mammoth lode claimed and located a tract of land parallel with said lode and including Jamison Creek, for working purposes, about the time of the location of said lode which claim included said creek and three hundred yards upon each side thereof within the limits of the patented premises and that they built a mill and claimed and used lumber on said tract for working purposes.

3rd. Neither the evidence nor the agreed statement of facts justifies the finding or decision that there was no possession of the land in controversy for mining purposes prior to the issuance of the patent, but both of them show on the contrary that there was constructive possession of the whole thereof for said purposes before said patent was applied for.

4th. There is no evidence nor any agreed facts to justify the finding that there was a custom in force in Jamison Mining District from 1856 to 1868 to record all notices of mining locations in the office of the County Recorder of Plumas County.

5th. Neither the evidence nor the agreed statement of facts justifies the finding or decision that no other notices than these set out in the 5th finding of fact were posted and published in the proceeding to obtain said patent; but show  
67 on the contrary that said proceedings were regularly conducted in respect to the posting and publication of all notices of the application for said patent.

6th. Neither the evidence nor the agreed statement of facts justifies the finding or decision that McGee and Thompson took no other or further steps to procure a patent for said claim but show on the contrary that they took all the steps necessary to forestall any opposition of any claimant to said premises or any part thereof.

7th. There is no evidence or agreed facts to justify the finding or decision that one John F. Banks on the 17th of June, 1876, entered upon and located twenty acres of land

upon which the town of Johnsville is now situated or to justify the implied finding that said Banks was ever in possession or had the right of possession of any part of the said land, or of any part of the premises in controversy.

8th. There is no evidence or agreed fact to justify the finding or decision that any part of the claim of said Banks passed by mesne conveyances to any defendant or defendants residing in the town of Johnsville.

9th. Neither the evidence nor the agreed statement of facts justifies the finding or decision that plaintiff at the time the action was commenced was not the owner of nor entitled to the possession of the land occupied by the defendants, but they both show on the contrary that plaintiff is and was at the time of the commencement of this action the owner of and entitled to the possession of all the premises described in the complaint of plaintiff herein.

H. L. GEAR,  
*Attorney for Plaintiff.*

The foregoing bill of exceptions is hereby allowed and settled as being correct, Dec. 30th, 1891.

HAWLEY, *Judge.*

68 Endorsed: Service of within received by mail Nov.  
10th, 1891.

GOODWIN & GOODWIN.,

Filed December 30, 1891. L. S. B. Sawyer, Clerk.

In the Circuit Court of the United States, Ninth Circuit,  
Northern District of California.

WM. H. LAKIN,		} No. 10,596.
	Plaintiff,	
	vs.	} No. 10,630.
O. B. DOLLY,		
	Defendant.	
	and	} No. 10,630.
WM. H. LAKIN,		
	Plaintiff,	} No. 10,630.
	vs.	
J. H. ROBERTS, ET. AL.,		
	Defendants.	}

These cases are actions of ejectment. The Dolly case is submitted on a stipulation "That defendant may move to set aside the judgment and for a new trial of the above entitled action without previous service of notice of intention and without showing of facts constituting surprise or excuseable neglect as a ground of the motion, it being agreed that if the facts hereinafter stipulated do as matter of law show a right of the defendant to defend the action successfully as against the plaintiff, under the pleadings defendant is entitled to a new trial of said action upon the ground of surprise and excuseable neglect, and that if such right so appears the said judgment may be set aside upon condition of the payment of the costs of plaintiff included in said judgment, and the judgment then be rendered in favor of defendant for his costs; but that if said facts do not show such right of successful defense as matter of law the motion of defendant is to be denied, and the verdict and judgment in favor of plaintiff are to be and to remain final."

The Roberts case is submitted by agreement of counsel upon the agreed statement of facts filed in the Dolly case.

From the agreed statement and the various exhibits referred to, the following among other facts are made to appear: viz.—That plaintiff holds the title to the premises in controversy, that was acquired by the patent of the United States to the Mammoth Gold Mining Company; that the lands in controversy are mineral lands and are situated with-

in the Jamison Quartz Mining District in Plumas County and embrace the land upon which the town of Johnsville is situate; that the patent issued to the Mammoth Gold Mining Company on the 18th day of May 1877, although it purports upon its face to be issued in pursuance of the Revised Statutes of the United States upon an entry made by the Mammoth Company, March 17th, 1877, was applied for by John B. McGee and James M. Thompson under the law of 1866, on August 30th, 1867; that the patent embraces two separate locations and conveys 4,100 feet of a gold bearing quartz lode with 252.95 acres of land; that the actual trend of the extension of the Mammoth lode upon the patented ground is unknown; that the lode as marked on the patent as well as located and fixed on the surface of the land, is in a straight line along the west or northwest boundary of said patented tract and is within fifty feet of said line; that the surface tract covered by the patent except said fifty feet is on the

71 east or southeast side of said lode and extends about three fourths of a mile therefrom; that the written laws adopted in 1851 by the miners of the Jamison Quartz Mining District, governing the location of quartz claims therein, made no provision for the location of surface ground in connection with quartz location in excess of one hundred feet on each side of the lode; nor was there any law, usage or custom authorizing the location or occupancy of more than one hundred feet of surface ground on each side of the lode; that the "Quartz miners of Jamison District who opened and worked mines on Eureka Mountain actually occupied such portion of public land as they chose for the purpose of working their mines, the extent of such occupation not being a matter of defined custom but of actual possession, but \* \* \* there was no actual possession of the land on which the village of Johnsville is situated except the road leading across the same from the Mammoth mine to the Mammoth Mill and to Jamison City;" that in 1867 McGee and Thompson procured a survey of the Mammoth claim and extension and of the exterior boundaries of the surface ground and had a diagram thereof made and thereupon, on the 30th day of August 1867, they posted on said Mammoth claim the following notice: "The undersigned give notice that they intend to apply for a patent for the vein or lode set forth in the above diagram called the Mammoth Quartz Claim, situated in the Jamison Mining District, County of Plumas, California, and now post this notice on a conspicu-

ous part thereof. Dated on the ground this 30th day of August, 1867.

“ JOHN B. MCGEE,  
“ JAS. M. THOMPSON.”

72 That on the 7th day of September 1867 they published in a local newspaper for the period of ninety days the following notice: viz.—“The undersigned give notice that they intend to apply for a patent for the vein or lode known as the Mammoth Quartz Claim, situated in the Jamison Mining District, County of Plumas, California, and now post this notice on a conspicuous part thereof: Commencing at an iron pin drilled into a rock on the line dividing the Mammoth Claim from the Eureka Claim, and running thence for the center of the vein northeast  $\frac{1}{4}$ , 100 feet, and including the land between the lode and Jamison Creek for working purposes. Dated on the ground this 30th day of August, 1867.

“ JOHN B. MCGEE,  
“ JAS. M. THOMPSON.”

That on the 17th day of June 1876 one John F. Banks entered upon and claimed twenty acres of land upon which the town of Johnsville is now situate, and located the same for building and agricultural purposes; that his claim thereto was recorded upon the records of Plumas County prior to the issuance of the patent to the Mammoth Company; that by certain mesne conveyances this tract of land has become vested in the defendants; that for more than ten years last past the town of Johnsville has been the center of trade and business of that section of country, with a population of over two hundred persons and laid off into streets, lots and blocks; that no portion of this tract of land occupied by defendants is within one thousand feet of the lode described in the patent; that said land has never been sectionized by the Government of the United States nor in any manner surveyed by the Government of the United States other than by the

73 survey made in the proceeding to obtain the patent to the Mammoth Quartz Lode under which plaintiff claimed title; that in the summer of 1883, for the first time the Sierra Buttes Mining Company from which complainant claims title demanded of the citizens of Johnsville that they should pay nominal rent to the Company for the land occupied

by them as town lots; that the defendant Dolly and several of the defendants in the Roberts case paid from one to five dollars each and no other or further (or further) payments of rent from them was ever demanded until the spring of 1889; that the other defendants in the Roberts case who entered upon the land subsequent to 1883, either obtained permission of said Company or entered upon the land with the understanding that the Sierra Buttes Gold Mining Company, did not object to the occupancy of the town lots as long as the enjoyment of its rights in the premises were not interfered with; that the lands embraced in the patent were assessed for State and County purposes from 1878 to 1888 to the mining company and it paid the taxes thereon; that after 1883 the defendants in the respective actions, were assessed for taxes, on their respective improvements on the land occupied by them and the taxes so assessed were paid by them; that in the spring of 1889 the plaintiff Lakin after he had acquired a judgment against the Sierra Buttes Gold Mining Company, enforcing a trust in the portion of the patented ground which include the premises in controversy notified the defendant Dolly and the defendants in the Roberts case, that they must either pay rent for the land occupied by them, purchase said land or quit the premises and remove their improvements therefrom within thirty days; that defendants neglected  
74 and refused to perform either of said requirements and remained in the possession of the premises.

Upon the foregoing facts the contention of defendants is that, under the provisions of section 2318 and 2320 Rev. St. U. S., the patent issued to the Mammoth Gold Mining Company is void as to all that portion of surface ground on the east or southeast side of the quartz lode in excess of 300 feet from the center of the lode. The contention of the plaintiff is, that the land department had jurisdiction to pass upon all questions of fact and to issue the patent, that its action in this respect is conclusive and cannot be collaterally attacked in an action of ejectment.

I had occasion in *Rose v. Richmond M. Company*, 17 Nev. 25; 114 U. S. 576, and in the recent case of *Whitney v. Taylor*, ————Fed. R.——— to thoroughly examine the question as to when, where and under what circumstances, a patent could be declared void and to determine the extent of the power of the land department of the Government of the United States to pass upon and decide jurisdictional facts. The question was referred to and discussed by Mr. Justice Sawyer in

Francoeur v. Newhouse 40 Fed. R. 623, and has been frequently raised and passed upon in a great variety of cases in the Supreme Court of the United States.

- Polks Lessee v. Wendall, 9 Cranch, 87;  
 New Orleans v. United States, 10 Pet., 662, 730;  
 Wilcox v. Jackson, Dem. McConnell, 13 Pet., 498, 509;  
 Stoddard v. Chambers, 2 How. 284, 317;  
 Easton v. Salsbury, 21 How. 426, 428;  
 Reichart v. Felps, 6 Wall, 160;  
 75 Best v. Polk, 18 Wall, 112, 117;  
 Eleavenworth Railroad v. United States, 92 U. S., 733;  
 Newhall v. Sanger, 92 U. S., 761;  
 Sherman v. Buick, 93 U. S., 209;  
 Smelting Co. v. Kemp, 104 U. S., 636;  
 Steele v. Smelting Co., 106 U. S., 447;  
 Kansas Pacific Railway Co. v. Dunmuir, 113, U. S.,  
 629, 642;  
 Reynolds v. Iron Silver Mining Co., 116 U. S., 687.

The general principles bearing upon this subject are very clearly announced by Mr. Justice Miller in delivering the opinion of the Court in Doolan v. Carr, 125 U. S. 624 as follows: "There is no question as to the principle that where  
 " the officers of the government have issued a patent in due  
 " form of law, which on its face is sufficient to convey the title  
 " to the land described in it, such patent is to be treated as  
 " valid in actions at law, as distinguished from suits in equity,  
 " subject, however, at all times to the inquiry whether such  
 " officer had the lawful authority to make a conveyance of the  
 " title. But if those officers acted without authority; if the land  
 " which they purported to convey had never been within their  
 " control, or had been withdrawn from that control at the  
 " time they undertook to exercise such authority, then their  
 " act was void—void for want of power in them to act on the  
 " subject matter of the patent, not merely voidable in which  
 " latter case, if the circumstances justified such a decree, a  
 " direct proceeding with proper averments and evidence would  
 " be required to establish that it was avoidable and should  
 " therefore be avoided. The distinction is a manifest one, al-  
 " though the circumstances that enter into it are not always  
 " easily defined. It is nevertheless a clear distinction, estab-  
 " lished by law, and it has been often asserted in this  
 76 " Court, that even a patent from the Government of the  
 " United States, issued with all the forms of law, may be  
 " shown to be void by extrinsic evidence, if it be such evi-



“ dence as by its nature is capable of showing a want of authority for its issue.” In the light of the authorities there can be no question as to the duty of this Court to investigate and determine whether or not defendants contention is well founded.

It is claimed by plaintiff that upon the facts of this case, and under the provisions of section 2328 and 5577 Rev. St. U. S., the patent must be considered and treated as having been issued under the Act of Congress of 1866; it is immaterial so far as the result of this decision is concerned whether the patent is construed with reference to the Act of 1866 or the subsequent provision of the Revised Statutes under and in pursuance of which the patent purports to have been issued. But I am of the opinion that the question as to the validity of the patent depends upon the construction to be given to section 2320 Rev. St. U. S. This section reads as follows:—

“ Mining claims upon veins or lodes of quartz or other rock  
 “ in place bearing gold, silver, cinnabar, lead, tin, copper, or  
 “ other valuable deposits, heretofore located, shall be governed  
 “ as to length along the vein or lode by the customs, regu-  
 “ lations and laws in force at the date of their location. A  
 “ mining claim located after the 10th day of May 1872,  
 “ whether located by one or more persons, may equal but  
 “ shall not exceed one thousand five hundred feet in length  
 “ along the vein or lode; but no location of a mining claim  
 “ shall be made until the discovery of the vein or lode within  
 “ the limits of the claim located. No claim shall extend  
 77 “ more than three hundred feet on each side of the  
 “ middle of the vein at the surface, nor shall any  
 “ claim be limited by any mining regulation to less than  
 “ twenty-five feet on each side of the middle of the vein at  
 “ the surface, except where adverse rights existing on the  
 “ 10th day of May 1872, render such limitation necessary.  
 “ The end lines of each claim shall be parallel to each other.”

This entire section seems to be clear, definite and certain. It provides that all mining claims upon quartz lodes located prior to its passage should be governed as to the length of the claim along the lode “by the customs, regulations and laws in force at the date of their location;” that the claims located after the 10th day of May 1872, “may equal, but shall not exceed one thousand five hundred feet in length along the vein or lode.” So far the section relates solely to the question of the length of the lode that may be located. It next takes up the question as to how much surface ground

will be allowed to the locator of a quartz lode and says that "no claim" evidently meaning all claims, whether coming within the first clause relating to claims located prior to the passage of this section or within the second clause relating to locations made subsequent thereto—"shall extend more than three hundred feet on each side of the middle of the vein at the surface." Having thus expressed the extent of the surface ground to which the locator may be entitled it further provides that the amount of surface ground shall not in any case, be limited by any mining regulations to less than twenty-five feet on each side of the middle of the vein at the surface except in certain contingencies which have no application to the facts of this case. After the passage of the act of which this section forms a part, it seems very clear to my mind, that the land department had no jurisdiction, power or authority to issue a patent for a quartz lode, to any surface ground exceeding three hundred feet in width on each side of the middle of the vein or lode. And that any patent which is issued for more than that amount of surface ground is absolutely null and void as to the excess over three hundred feet and can be collaterally attacked in a Court of law.

The principles announced in *Smelting Co. v. Kemp*, 104 U. S. 636, in so far as the same are applicable to these cases, fully support the conclusions I have reached. There, as herein, the patent was regular upon its face "unless some limitation in the law as to the extent of a mining claim which can be patented, has been disregarded." In the course of an exhaustive and able opinion by Mr. Justice Field, quoting from *Patterson v. Winn* 11 Wheat. 380, it is said "that if a patent was issued without authority or was prohibited by statute \* \* \* it could be impeached collaterally in a Court of Law in an action of ejectment."

In explanation of the phrase "that if the patent be absolutely void on its face it may be attacked collaterally, impeached in a Court of Law," the learned Justice, delivering the opinion of the Court, said, "It is meant that the patent is seen to be invalid, either when read in the light of existing law or by reason of what the Court must take judicial notice of; as for instance \* \* \* that the patent is for an unauthorized amount." The contention of the defendant in that case rested upon the correctness of their assertion that a patent could not issue for a placer mining claim, which embraced over one hundred and sixty acres.

This contention was sought to be maintained upon the theory that the applicant for a patent could not embody in his application any mining ground that he had purchased from other locators. The Court held that there was no valid reason, and nothing in the language of the acts of Congress which prevented an individual from acquiring by purchase the mining ground located by others and adding it to his own. The views therein expressed are conclusive as to the right of the applicant for a patent to the Mammoth Quartz lode to embrace in their application two or more separate locations owned by them on the same lode.

In Parleys Park Mining Company vs. Kerr, the question was presented whether the patent issued for a quartz lode was void because it embraced more than two hundred feet in width of surface ground. The question thus raised was substantially the same as presented here, but the facts were different. There it was shown that the rules adopted on the 17th of May by the miners of the district, where the lode was located, provided "that the surface width of any mining location shall not exceed one hundred feet in width on each side of the wall rocks of said lode." But it also appeared that in anticipation of the Act of Congress of May 10, 1872, (section 2326 Rev. St.) there was a meeting of miners held in said district on the 4th of May, 1872, and the rules of the district were altered and amended so as to provide that "the surface width shall be governed by the laws of the United States of America," and the Court very properly held that in view of this testimony the land department had a right to determine which of these rules were in force. What the result of the opinion would have been if there had been no amendment to the mining rules is made clear by the language of the Court in its reference to the rules and regulations of the miners adopted in 1870, limiting the surface ground to two hundred feet. Upon this point the Court said, "had that regulation remained in existence and been in operation at the time the Clara claim was located, its effect upon the legality and validity of that location, at least as to all the land in excess of two hundred feet, could not be doubted." (130 U. S. 261.)

In the case under consideration the surface ground upon which the town of Johnsville is situated, embracing the lands claimed by defendants, was never possessed or located as a part of the Mammoth Quartz lode and there was no law of the United States at the time the application was made for a

patent in 1867 or when the patent was issued in 1877, or any State law, or any local rules, regulations or custom of the miners in Jamison Mining District which authorized or permitted any such location to be made. That patent, in so far as it includes any of said ground, was issued without any authority of law and is therefore null and void.

Does the agreed statement of facts establish such a tenancy between the respective parties as to estop the defendants from denying the title of the plaintiff to the lands in controversy? The general rule that a tenant cannot dispute his landlord's title is too well settled to require any discussion or citation of authorities. This rule, however, is subject to various exceptions and qualifications equally as important and well established as the rule itself. Among the exceptions are

(1) Where the tenant was induced to take a lease by mistake, fraud or misrepresentation on the part of the lessor;

(2) Where both parties acted under a mutual mistake  
81 as to the law in regard to the title of the lessor; (3)

Where the tenant did not take possession of the property under the lease, but was in the possession at the time he took his lease.

*Tewksbury v. Magraff*, 33 Cal., 341.

*Franklin v. Meridia*, 35 Cal., 575.

*Schultz v. Elliot*, 11 Humph., 187.

*Hammons v. McClure*, 85 Tenn., 5.

*Miller v. McBrier*, 1 Serg. & R., 382.

*Swift v. Dean*, 11 Vt., 323.

*Carter v. Marshal*, 72 Ill., 609.

(Big. Est. Sec. 399, 409, 527, 2 Tay. Land & Ten. Sec. 707, Woods Land & Ten., 364, 374.)

The principles of law relating to these exceptions are elaborately stated and the reasons given in support thereof are so clearly enunciated in the authorities cited that I deem it unnecessary to discuss this branch of the case at any length. The third ground above stated is the only one upon which there is any dissent. It would probably require, in certain cases, some qualification and depend, to a great extent in all, upon the particular facts of each case. But upon the agreed statement of facts in this case the exceptions mentioned are directly applicable to this case and, in my judgment, conclusive in favor of the right of defendants to show that the plain-

tiff did not acquire any title to the lands in controversy by virtue of the patent for the Mammoth Quartz lode.

It is certainly clear that the parties have acted under a mistake as to the law in regard to the title of plaintiff. Estoppels are said to be odious in law, as they have a tendency to prevent a full, complete and thorough investigation of the truth, and in order to be operative in any case, ought to be certain to every intent, precise, clear and unequivocal, and not  
82 depend upon inference.

The facts agreed to fall far short of establishing the complete relation of landlord and tenant, express or implied, so as to have the effect in law to estop the defendants from asserting the truth. At the time of the commencement of these suits the defendants were in possession of the lands occupied by them under the possessory title, originally acquired by Banks, and although they have no title from the Government of the United States, they are in a position to show that they have a better right to the lands than plaintiff.

If the defendants were simply in the possession as mere naked trespassers, without any question of tenancy being raised, they could in defense of such possession attack the validity of the plaintiff's title, for it has been held by the Supreme Court of the United States that in cases of this character, as in all other cases of ejectment, the plaintiff must recover on the strength of his own title and not upon the weakness of defendants:

Reynolds v. Iron Silver Mining Co., 116 U. S., 688.

Doolan v. Carr, 125 U. S., 688.

The facts agreed upon, with reference to the payment of taxes, are irrelevant and immaterial as they do not establish any title in either party.

In the pursuance of the stipulation and agreement of counsel it follows, from the conclusions reached, as to the law of the case, that in the case of Lakin v. Dolly the judgment heretofore entered in favor of the plaintiff, must be set aside upon the payment by defendant, of the costs of plaintiff's included in said judgment, and judgment be entered in favor of defendant for his costs. And in Lakin v. Roberts et. al.,  
83 judgment must be entered in favor of defendants for their costs.

It is so ordered.

HAWLEY, *Judge.*

Endorsed: Opinion read in open Court, March 23, 1891.  
L. S. B. Sawyer, Clerk.

(Here follow pages 84 and 85 in the original record containing the petition for writ of error, which is omitted from this printed record pursuant to stipulation.)

*Assignment of Errors.*

86

(Title of court and cause.)

Plaintiff in error makes the following assignment of errors committed by the Circuit Court in and for the Ninth Circuit, Northern District of California, in the consideration and determination of the action wherein said Wm. H. Lakin is plaintiff and said defendants above named and others are defendants, and which plaintiff in error asks to have received in said Circuit Court of Appeals upon Writ of Error to said Circuit Court.

87 1st. The said Circuit Court erred in rendering judgment in favor of the defendants in error upon the findings and in not rendering judgment in favor of the plaintiff thereupon.

2nd. The Circuit Court erred in overruling the objection of plaintiff to proof of the mining rules of Jamison Mining District and in admitting proof of the same for the purpose of assailing the patent under which plaintiff claimed title. The full substance of the evidence, in regard to said rules, is set out in the Bill of Exceptions in said action, which is hereby referred to and made part of these assignments of errors.

3rd. The Circuit Court erred in overruling the objection of plaintiff to proof of the custom of miners in said District and in admitting said proof for the purpose of assailing the patent under which plaintiff claimed title. The full substance of the evidence, in regard to said custom, is set out in said Bill of Exceptions, which is hereby referred to and made part of this assignment of errors.

4th. The Circuit Court erred in overruling the objection of plaintiff to proof of the possessory claim of John Banks in support of the possession of the defendants. The full substance of the evidence, in regard to said claim, is set out in said Bill of Exceptions, which is hereby referred to and made part of this assignment of errors.

5th. The decision of said Circuit Court is against law in allowing the mining patent under which plaintiff claims title

to be collaterally assailed by the defendants in this action.

88 6th. The decision of said Court is against law in holding that said patent is void as to any of the land occupied by said defendants or as to any part of the premises in said patent described.

7th. The decision of said Court is against law in holding that at the time this action was commenced plaintiff did not own or was not entitled to possession of the land occupied by said defendants.

8th. The decision of said Court is against law in deciding that as to any of said defendants that said action should be dismissed and in awarding judgment to any of them for their costs and disbursements.

9th. That said Circuit Court erred in finding as a fact "That there was not at any time prior to 1868 any law, usage or custom in force in Jamison Mining District authorizing the location or occupancy of more than one hundred feet of surface ground on each side of the lode located," and the said finding is not justified by the statement of facts agreed to by the parties nor by evidence, and is conclusively contradicted by the record of the land office as to the application and proceedings for the patent under which plaintiff claims. The substance of all the evidence pertaining to said finding of fact is set out in said Bill of Exceptions, which is hereby referred to and made part of this assignment of errors.

10th. The said Circuit Court erred in finding as a fact that "no surface ground was claimed along the line of the said Mammoth lode," and the said finding is not justified by the evidence, which shows that the locators of said Mammoth lode claimed and located a tract of land parallel with  
89 said lode, and including Jamison Creek, for working purposes, about the time of the original location of said lode, which claim included said creek and three hundred yards on each side thereof within the limits of the patented premises. The substance of all the evidence relating to the location, possession and working of said claims is set out in said Bill of Exceptions, which is hereby referred to and made part of this assignment of errors.

11th. The Circuit Court erred in finding as a fact that there was no possession of the land in controversy for mining purposes prior to the issuance of the patent under which plaintiff claims title, and the said finding is not justified by the evidence, which shows constructive possession of the whole thereof for said purpose before said patent was applied for.

The substance of all the evidence relating to said possession is set out in said Bill of Exceptions, which is hereby referred to and made part of this assignment of errors.

12th. The Circuit Court erred in finding as a fact that there was a custom in force in Jamison Mining District from 1856 to 1868 to record all notice of mining locations in the office of the County Recorder of Plumas County and there is no evidence to sustain or justify said finding. The said Bill of Exceptions contains all the evidence relating to the rules and customs of miners in said district, and is hereby referred to and made part of this assignment of errors.

90 13th. The Circuit Court erred in finding as a fact that no other notices than those set out in the fifth finding of fact were posted and published in the proceeding to obtain said patent, and said finding is contrary to the evidence in regard to said proceeding, all of which is contained in said Bill of Exceptions, which is hereby referred to and made part of this assignment of errors.

14th. The Circuit Court erred in finding as a fact that McGee and Thompson took no other or further steps to procure a patent than those set out in said findings, and said finding is not justified by the evidence, which shows that they took all steps necessary to forestall any opposition by any claimant to said premises or any part thereof, said evidence is fully set out in said Bill of Exceptions, which is hereby referred to and made part of this assignment of errors.

15th. The Circuit Court erred in finding as a fact that one John F. Banks on the 17th day of June, 1876, entered upon and located twenty acres of land upon which the town of Johnsville is now situated and said finding is not justified by the evidence, there being no evidence to show that said Banks was ever in possession or has a right of possession of any part of said land, or of any part of the premises in controversy or that he lawfully located the same. All the evidence pertaining to said matters is set out in said Bill of Exceptions, which is hereby referred to and made part of this assignment of errors.

16th. The Circuit Court erred in finding as a fact that the claim of said Banks passed by mesne conveyances to  
91 the defendants residing in the town of Johnsville, and said finding is not justified by the evidence, there being no evidence to support it, as shown by said Bill of Exceptions, which is hereby referred to and made part of this assignment of errors.



17th. The Circuit Court erred in finding that plaintiff, at the time of the commencement of the action, was not the owner of nor entitled to the possession of the land occupied by the defendants, and said finding is not justified by and is contrary to the evidence, which shows that said plaintiff is and was at the time of the commencement of said action the owner of and entitled to the possession of all of said premises and of all the premises described in the complaint of plaintiff therein.

Wherefore plaintiff in error prays that the judgment rendered in said action by said Circuit Court on the 31st day of October, 1891, in favor of said defendants in Error and against this plaintiff, whereby the said action was dismissed as to said defendants and each at the cost of said plaintiff be reversed by said Circuit Court of Appeals and that said Circuit Court of Appeals render judgment upon the record in said action in favor of this plaintiff and against each and all of said defendants, as prayed for in his complaint.

H. L. GEAR,

*Attorney for Plaintiff in Error.*

Endorsed: Filed December 30, 1891.

L. S. B. Sawyer, Clerk.

(Here follows pages 92 and 93 of the original record, containing bond on Writ of Error, which is omitted from this printed record pursuant to stipulation.)

*Certificate of Record.*

(Title of court and cause.)

I, L. S. B. Sawyer, Clerk of the Circuit Court of the United States of America, of the Ninth Judicial Circuit, in and for the Northern District of California, do hereby certify the foregoing ninety-three written and printed pages, numbered from 1 to 93 inclusive, to be a full, true and correct copy of the record and of the proceedings in the above and therein entitled cause, and that the same together constitute the return to the annexed Writ of Error.

In testimony whereof, I have hereunto set my hand and

affixed the Seal of said Circuit Court, this 26th day of January, A. D., 1892.

L. S. B. SAWYER,

*Clerk U. S. Circuit Court, Northern District of California.*

{ SEAL }

*Writ of Error.*

UNITED STATES OF AMERICA, ss.:

The President of the United States, to the Honorable, the Judge of the Circuit Court of the United States for the Northern District of California, Greeting:

Because in the record and proceedings, as also in the rendition of the judgment of a plea which is in the said Circuit Court before you, between Wm. H. Lakin, plaintiff in error, and J. H. Roberts, W. C. Roberts, M. Kerr and Mrs. Kerr, his wife, P. Laurenzi, John Daly, P. Tivenon, M. Antonovich, J. F. Bacher, John Willoughby, John Nevill, John Knight, A. Curtis, D. Robinson, H. B. Houghton, J. F. Houghton, John Thomas, James Menzies, George Woodward, Mrs. Anna Jenkins, O. B. Dolly and Mrs. Dolly, his wife, M. A. Passetta, B. L. Jones, M. Willoughby, W. H. Thomas, John Powning, Sol. Babb and Mrs. Babb, his wife, Geo. Hake, G. E. Cook, Frank Meffley, Geo. Maxwell, Robert Penman, L. Cipriotto, Frank Tucker, H. S. Dunn, Wm. Littecott, John Creighton, F. Vanzini, Edward Mitchell, Wm. Gallagher, A. Grazier, H. Perin, M. Curtis, E. Stephens, Jack Moni, Henry Doney and L. Grondoni, defendants in error, a manifest error hath happened, to the great damage of the said Wm. H. Lakin, plaintiff in error, as by his complaint appears.

We, being willing that error, if any hath been, should be duly corrected, and full and speedy justice done to the parties aforesaid in this behalf, do command you, if judgment be therein given, that then under your seal, distinctly and openly you send the record and proceedings aforesaid, with all things concerning the same, to the UNITED STATES CIRCUIT COURT OF APPEALS FOR THE NINTH CIRCUIT, together with this writ, so that you have the same at the City of San Francisco, in the State of California, on the 29th day of January next, in the said Circuit Court of Appeals, to be then and there held, that the record and proceedings aforesaid being inspected, the said Circuit Court of Appeals may cause further to be done therein to correct that

error what of right, and according to the laws and customs of the United States, should be done.

Witness the Honorable Melville W. Fuller, Chief Justice of the Supreme Court of the United States, the 30th day of December, in the year of our Lord, One Thousand Eight Hundred and Ninety-one.

D. MONCKTON,

*Clerk of the U. S. Circuit Court of Appeals for Ninth Circuit.*

{ SEAL }

Allowed by Hawley, Judge.

*Return to Writ*

The Answer of the Judges of the Circuit Court of the United States, of the Ninth Judicial Circuit, in and for the Northern District of California.

The record and all proceedings of the plaint whereof mention is within made, with all things touching the same, we certify under the Seal of our said Court, to the United States Circuit Court of Appeals for the Ninth Circuit, within mentioned, at the day and place within contained, in a certain schedule to this Writ annexed, as within we are commanded.

By the Court:

L. S. B. SAWYER, *Clerk.*

{ SEAL }

Endorsed: Filed December 30, 1891. L. S. B. Sawyer, Clerk U. S. Circuit Court, Ninth Circuit, Northern District of California.

(Here follows citation with admission of service by Goodwin & Goodwin, attorneys for defendants in error and agreement by them to appear, omitted pursuant to stipulation.)

*Stipulation as to Printing of Record.*

(Title of court and cause.)

It is hereby stipulated between the parties to the above-entitled cause that the printing of the record on behalf of the plaintiff in error need not include the summons or return thereof, the additional findings and judgment for plaintiff against

certain defendants as to which no errors are assigned or the petition for writ of error, citation, or bond, but need only include the pleadings, findings and judgment for defendants in error, the bill of exceptions, the assignment of errors, and the writ of error and return thereof, and the opinion of the Court below, and that there need be no unnecessary repetition of the Court and cause, and that the pleadings may be stated to be duly verified.

H. L. GEAR,

*Attorney for Plaintiff in Error.*

GOODWIN & GOODWIN,

*Attorneys for Defendants in Error.*

No. 28.

---

IN THE

# United States Circuit Court of Appeals.

NINTH CIRCUIT.

April Term, 1892.

---

WM. H. LAKIN, Plaintiff in Error,

vs.

J. H. ROBERTS et al., Defendants in Error.

---

BRIEF FOR PLAINTIFF IN ERROR.

---

H. L. GEAR,

*Attorney for Plaintiff in Error.*

---

FILED  
APR - 5 1892



IN THE  
United States Circuit Court of Appeals.

NINTH CIRCUIT.

---

WILLIAM H. LAKIN,  
*Plaintiff in Error,*  
*vs.*  
J. H. ROBERTS, *et al.,*  
*Defendants in Error.*

---

BRIEF OF PLAINTIFF IN ERROR.

1. Statement of the Case.

This was an action of ejectment brought by the plaintiff in error against the defendants in error, to eject them as trespassers from a patented mining claim, a portion of which is described in the complaint (original record, pp. 2 to 4), and to which plaintiff deraigns title from the original patentee, the Mammoth Gold Mining Company, through the Sierra Buttes Co., its grantee (pp. 32, 43, 58.) The answer denies plaintiff's title, and pleads adverse possession, and avers that defendants are in possession of lots in the town of Johnsville, situated on the land claimed by plaintiff (pp. 22 to 26.)

The question of adverse possession is not raised by the facts appearing in the record. Plaintiff in error claims that his title has been admitted by tenancy of the defendants under plaintiff's grantor (p. 47). Defendants in error, on the other hand, though they have shown no paramount title in themselves, and have not connected themselves with any paramount title, claim that their mere possession of patented mineral lands, which are confessedly mineral (pp. 28, 46), a portion of which they occupy for the purpose of village lots, entitles them to assail collaterally the validity of the patent under which the plaintiff claims, on the grounds:

1st. That the patent, though granted upon an application and survey made under the Act of Congress of July 26th, 1866, having been granted since the adoption of the Revised Statutes, could not include more than three hundred feet on each side of the ledge; and,

2d. That they can show by *evidence aliunde* that the mining laws of the district did not warrant the grant of so much land as was patented.

Their position was sustained by Judge Hawley, who determined the case in the Circuit Court, and whose opinion appears in the record (pp. 69-83. The questions as to the tenancy and its effect upon



the defendants, and as to the propriety of, sustains their assault upon the validity of the mineral patent, involve the whole of the case to be decided by this Court.

The case was submitted for decision upon an agreed statement of facts, including exhibits, affidavits and documentary evidence, stipulated between the parties, subject to certain objections specified in the stipulation, upon which the Court passed in deciding the case (pp. 43 to 44, 63, 64). The record discloses the following state of facts:

In July, 1851, the Mammoth Company located 2,100 feet of a quartz ledge on Eureka Mountain in Jamison Mining District, Plumas County, Cal., without specifying in the notice of location any surface ground, but at the time of the location, located and recorded a claim of a tract of land on Jamison Creek, at the base of the mountain, claiming three hundred yards in length along the creek for mill purposes and timber for mining, and built a mill on it, run tunnels and constructed a wagon road and tramway from the tunnels to the mill across the present site of Johnsville, which is about 1,000 feet from the lode line described in the location and patent, and extends about 700 feet in width to within about 200 feet from the creek, which would make the present site of Johnsville within the

limits of the 900 feet in width claimed for mill site purposes along Jamison Creek on the side where the mill was built, between the ledge and the creek (p. 50), though there was no actual possession of the land on which the village of Johnsville is now situated, except the road leading across the same from the river to the mill (p. 49).

On November 4th, 1865, a northeasterly extension of the mine was located without additional claim of surface ground. The actual direction of the extension was obscured farther than has been indicated by the workings in the original ledge and the general direction of the foot wall (p. 51), which indicates an actual trend of the lode passing through the village of Johnsville (p. 46).

On August 26th, 1867, the then owners of the Mammoth Claim and extension, Thompson and McGee, had a survey made of the 4,100 feet of lode and 252 and 95-100 acres of ground, extending to and across Jamison Creek and including the original Mammoth Millsite Claim, on both sides of the creek, and the whole of the present site of Johnsville, no part of the village being then in existence. Monuments were then marked on the ground to indicate the boundaries, and the survey was made as the basis of an application for a patent, and was afterward approved by the Surveyor-

General as the final survey of the land for which the patent was issued. On August 30th, 1867, a diagram of the survey and notice of intention to apply for a patent was posted on the claim (p. 51). On September 7th, a notice of intention to apply for a patent for the Mammoth Quartz Claim was published in a newspaper, the notice describing the lode line of 4,100 feet, "and including the land between the lode and Jamison Creek for working purposes," which publication was continued for ninety days (p. 52).

On the 11th of September, 1867, application was made for a patent for the land included in the survey, under the Act of Congress of July 26, 1866, alleging that the applicants had occupied and improved the same in accordance with the local customs and rules of miners, and that they presented a diagram so extended as to conform to the rules of the mining district, etc. The Register of the Land Office made an order for publication of notice of the application for ninety days (p. 53). On Feb. 27th, 1877, the Register certified to due posting and publication of notice for ninety days, and that no adverse claim had been filed. On March 2d, 1877, the Surveyor-General made his final report of survey, approving the original preliminary survey attached thereto, which certified that on the

28th day of August, 1867, there were three tunnels on the claims; that there was a mill for reducing rock on Jamison Creek and plenty of timber near the mill for all purposes (p. 54). On the same day affidavits were filed in the Land Office showing that the Mammoth Gold Mining Company was the successor in interest of Thompson and McGee, and had had possession of all the surface ground included in the application since June, 1870, and had expended \$50,000 in valuable improvements; that search had been made for mining rules and regulations but none were found and none were believed to be in existence, or to have been in existence for many years (p. 55).

On March 17th, 1877, a mineral entry was made by said company as the assignee and successor of Thompson and McGee, purporting to be "in pursuance of the Mining Act of Congress, approved July 26, 1866," and describing the land included in Thompson and McGee's survey and application for patent (p. 56). The patent fully identifies the entry and survey, but purports to be executed "in pursuance of the Revised Statutes of the United States," and recites that the entry was "in pursuance of said Revised Statute," and conveys the premises to the Mammoth Gold Mining Company (p. 57), in accordance with the descriptions in the

entry and survey (pp. 54, 56-7). The plaintiff claims under this patent, and the title to the premises in controversy depend upon its validity, and upon the right of the defendants to assail it.

For the purpose of showing under the stipulation, subject to plaintiff's objection, what were the mining rules and customs of miners in Jamison Mining District, defendants filed affidavits, the substance of which is set forth in the record, showing different statements by different persons as to the contents of the original rules adopted in 1851, which were destroyed by fire in 1862 (pp. 58-59); and that the plaintiff filed counter affidavits, showing that the rules never contained any limitation as to the amount of surface ground to be claimed, and that no rules were in existence at the time of the location of the extension in 1865 (pp. 60, 61). Defendants, to show the customs of miners, subject to the same objection, filed an abstract of the records of lode locations from 1856 to 1868, which disclosed no uniformity of custom as to the amount of lode claim or of surface ground located by different claimants, numbers of them claiming generally sufficient ground for working purposes, without mention of any distinct quantity of surface, and a few others specifying various widths of surface (pp. 61, 62).

The stipulation agreed, subject to plaintiff's objections to their irrelevance and materiality and incompetency, that the record of a claim by one John Banks and of conveyances from him to a portion of the defendants', might be shown as exhibits for defendants (p. 47).

The defendants filed as an exhibit a certified copy of a record of a claim by said Banks of twenty acres for building and agricultural purposes, recorded June 20th, 1876, but filed no exhibits showing any conveyance or conveyances from him to any person (p. 63). It is agreed that Johnsville has for ten years last past had a population of about 200 persons, and has been laid out in streets and lots and used as a center of business, and that a plat of it was surveyed in the summer of 1889, by A. W. Keddie, and filed with the County Recorder of Plumas County, a copy of which was appended to the answer (p. 45). This action was commenced the same year, December 15th, 1889 (p. 21). In 1883 a number of the defendants and their grantors paid rent to the Sierra Buttes Mining Company, the grantor of plaintiff, and the remainder of the defendants have since entered thereupon, either with the express or implied permission of the Sierra Buttes Company, with the understanding that it did not

object to occupation of lots while not interfering with its use and enjoyment of the patented premises (pp. 47, 48).

## II. Specification of Errors Relied Upon.

1st. The Circuit Court erred in rendering judgment in favor of the defendants in error upon the findings, and in not rendering judgment in favor of the plaintiff thereupon.

2d. The decision of the Circuit Court is against law in allowing the mining patent under which plaintiff claims title to be collaterally assailed by the defendants in this action, and in holding that the patent is void as to any of the land occupied by said defendants, or as to any parts of the premises in the patent described, and that at the time this action was commenced plaintiff did not own and was not entitled to the possession of the land occupied by said defendants, and in deciding that, as to any of said defendants, said action should be dismissed, and in awarding judgment to any of them for their costs and disbursements.

3d. The Circuit Court erred in overruling the objection of plaintiff to proof of the mining rules of Jamison Mining District, and in admitting proof of the same for the purpose of assailing the patent under which plaintiffs claimed title.

The substance of the evidence thus erroneously admitted consisted of the affidavits of John S. Graham, J. D. Byers, George Woodward, Sol. Babb, John P. Hills and A. Jump, each stating in substance that the original mining rules adopted by the miners of Jamison Mining District were destroyed by fire in the year 1862; that rules in writing for said district were adopted at a meeting of miners in 1851, and that the affiant was familiar with said rules. The affidavit of John S. Graham states that the rules originally authorized each person to locate not to exceed thirty feet on a quartz ledge or lode, and not to exceed 250 feet on each side of said thirty feet of ledge located, and that the rules were subsequently changed so as to limit the location of a quartz claim to twenty feet along the ledge, including the dips, spurs and angles. The affidavit of J. D. Byers states that the size of quartz claims required by the laws adopted in 1851, was twenty feet to each man along the course of the ledge, including the dips, spurs and angles; that he could not remember the exact amount of surface ground authorized to be located on each side of a lode claim, but it is certain it did not exceed one hundred feet on each side of the lode or vein located. The affidavit of George Woodward states that said written rules, adopted in 1851, authorized each person to locate not to exceed thirty



feet along the line of the lode or ledge, with all of the dips, spurs and angles of the ledge, and to hold surface ground on each side of the ledge or vein not to exceed one hundred feet. The affidavit of Sol. Babb, states that the rules originally authorized each person to locate not to exceed thirty feet on a quartz ledge or lode, and not to exceed one hundred feet on each side of said thirty feet of ledge located, and were subsequently changed so as to limit the locator of a quartz claim to twenty feet along the ledge, including the dips, spurs and angles. The affidavit of John P. Hills. states that said written laws originally authorized each person to locate twenty feet along the lode or vein; that he did not remember definitely the amount of surface ground on each side of the lode which each claimant could hold; but it is certain that the rules did not authorize the location of more than one hundred feet on each side of the ledge, and knows of no change authorizing any greater amount of surface ground. The affidavit of A. Jump, states that in 1851 and 1852, he had in his possession a copy of the local rules and records of Jamison Mining District, and became well acquainted with them, and the said rules authorized each miner to locate not to exceed twenty feet on a quartz ledge or lode, including the dips and angles thereof. This last affidavit appears to have been prepared in blank

by some other person before the filling up of the same and signature thereof by said Alembly Jump, and the following words are erased therefrom, “ and not to exceed        feet on each side of said        feet of ledge so located ” (pp. 58, 59). The plaintiff objected to the consideration of these affidavits, on the ground that any proof of the mining rules of Jamison Mining District, adopted prior to 1867, was irrelevant, immaterial and incompetent. The Court overruled the objection, and admitted and considered said evidence in its decision, to which ruling plaintiff duly excepted (p. 63).

4th. The Circuit Court erred in overruling the objection of plaintiff to proof of the customs of miners in said Jamison Mining District, and in admitting said proof for the purpose of assailing the patent under which plaintiff claimed title. The full substance of the evidence in regard to said customs consists of a certified abstract of all lode locations made in Jamison Mining District, and recorded upon the records of Plumas County prior to 1868, filed as an exhibit for defendants to show the custom of miners as to the extent of vein and surface claimed by locators of ledges therein, showing that in the year 1856 two locations were recorded, one by three persons claiming 125 feet of the lode, with its dips, spurs, and angles, without

mention of surface, and the other by five persons claiming 275 feet "embracing all the dips and angles of the ledges together with surface ground necessary to work the ledge." In 1865 eight locations were recorded, the first four making no mention of surface ground and claiming 100 feet of ledge to each locator along the ledge, with its dips, spurs and angles. The other four were locations of 200 feet of ledge to each locator with one claim for discovery, claiming the ledge with all its dips, spurs, angles and branches to the width of 500 feet. In 1860 eight locations were recorded, one by fourteen claimants of 3,000 feet of ledge without mention of surface ground, the other seven being at the rate of 100 feet of vein to each locator, including all dips, spurs and angles of the ledge, four of them making no mention of surface, two others calling for "sufficient ground on either side for fully developing and working the same," one other containing the words "together with all necessary appurtenances thereto for working and developing the ledge," one calling simply for "appurtenances," and the remaining one of the eight containing the words "together with all appurtenances necessary for developing the ledge." In 1862 three locations were recorded, two of them by locators claiming at the rate of 100 feet each, and the third by eleven locators claiming 2,500 feet of ledge, all three locations

claiming all dips and angles of the ledge without mention of surface ground. In 1863 two locations were recorded, one by seven locators claiming 100 feet and all quartz lodes within 125 feet of the ledge "and sufficient ground upon each side thereof for the convenience of working the same; and one by thirty locators of 3,000 feet of ledge and all quartz veins within 125 feet, "also all the land wood and water within twenty rods of the said "ledge." In 1864 one location was recorded by fifteen persons of 2,000 feet of ledge, "with all dips, spurs and angles of the same" with no mention of surface ground. In 1865 six locations were recorded, three of them making no reference to surface ground, two claiming 200 feet, and one claiming 100 feet on each side of the ledge. Two of them claimed 100 feet of vein to each locator, and the other four claimed 200 feet of vein to each locator, one of these being the Mammoth Extension claim of 2,000 feet, located by James M. Thompson, John B. McGee and eight others. In 1866 two locations were recorded, one by five locators, claiming 1,200 feet of ledge, with all its dips, spurs and angles, without mention of surface ground, and the other by six locators claiming 200 feet each, with 150 feet of ground on each side of the ledge. This evidence was objected to by plaintiff as irrelevant, immaterial and incompetent. The Court overruled the

objection and admitted and considered said evidence in the decision of the cause, to which ruling plaintiff excepted.

5th. The Circuit Court erred in overruling the objections of plaintiff to the certified copy of the claim of John Banks, filed as an exhibit for defendants, which shows in substance that on the 20th of June, 1876, said John Banks recorded upon the records of Plumas County a notice of a claim of twenty acres of land "for building and agricultural purposes," and described as follows: "Commencing at a spruce pine tree on the west bank of Jamison Creek, on the N. E. line of the Mammoth Mill ground; thence along said line in a N. W. direction to the base of the mountain; thence in a N. E. course along the base of the mountain ninety yards; thence in a S. E. course by a large cedar and dead pine tree to the brow of said flat; thence up the brow of said flat to the place of beginning" (p. 63.) This evidence was objected to as irrelevant, incompetent and immaterial, and the Court overruled these objections, and admitted and considered said claim in the decision of the cause, to which ruling plaintiff duly excepted (p. 64.) No evidence appears in the record to identify the boundaries of this claim, or to show that this claim includes the land occupied by any of the defend-

ants, or that any portion of it was conveyed to any specified defendant.

6th. The plaintiff in error also assails the findings of fact as unsustained by the evidence in the following particulars:

*a.* Neither the evidence nor the agreed statement of facts justifies the finding or decision by the Court "that there was not at any time prior to 1868, any law, usage or custom in force in Jamison Mining District authorizing the location or occupancy of more than 100 feet of surface ground on each side of the lode located" (p. 29); but the evidence and the agreed statement of facts show the contrary facts to be true (pp. 55, 60, 61, 62), and the said finding is conclusively contradicted by the records of the Land Office, which show that Thompson and McGee at the time of their application for a patent in 1867 had theretofore occupied and improved the premises applied for in accordance with the local rules, customs and rules of the miners in said district, and that there was then in controversy as to their claim to the whole of said premises, and that it was proved to the Land Department that there were no mining rules or customs in force precluding the occupancy of the whole thereof, or the application for a patent for the whole of said premises, or the granting of a patent for the same (pp. 53, 54, 55).

*b.* Neither the evidence nor the agreed statement of facts justifies the finding or decision of the Court that “no surface ground was claimed along the line of said Mammoth lode” (p. 290), or the implied finding or decision that no surface ground parallel to said lode was claimed by the locators thereof; but they show, on the contrary, that the locators of said Mammoth lode claimed and located a tract of land parallel with said lode and including Jamison Creek, for working purposes, about the time of the location of said lode, which claim included said creek and three hundred yards upon each side thereof within the limits of the patented premises, and that they built a mill and claimed and used lumber on said tract for working purposes (p. 50).

*c.* Neither the evidence nor the agreed statement of facts justifies the finding or decision that there was no possession of the land in controversy for mining purposes prior to the issuance of the patent (p. 30), but both of them show, on the contrary, that there was constructive possession of the whole thereof for said purposes before said patent was applied for (pp. 50, 51).

*d.* There is no evidence nor any agreed facts to justify the finding that there was a custom in force in Jamison Mining District from 1856 to 1868 to

record all notices of mining locations in the office of the County Recorder of Plumas County.

*e.* Neither the evidence nor the agreed statement of facts justifies the finding or decision that no other notices than these set out in the 4th finding of fact were posted and published in the proceeding to obtain said patent (p. 31); but show, on the contrary, that said proceedings were regularly conducted in respect to the posting and publication of all notices of the application for said patent (pp. 53, 54).

*f.* Neither the evidence nor the agreed statement of facts justifies the finding or decision that McGee and Thompson took no other or further steps to procure a patent for said claim (p. 31), but show, on the contrary, that they took all the steps necessary to forestall any opposition of any claimant to said premises or any part thereof (pp. 53, 54).

*g.* There is no evidence or agreed facts to justify the finding or decision that one John F. Banks on the 17th of June, 1876, entered upon and located twenty acres of land upon which the town of Johnsville is now situated (p. 32), or to justify the implied finding that said Banks was ever in possession or had the right of possession of any part of the said land, or of any part of the premises in controversy (pp. 47, 63).



*h.* There is no evidence or agreed fact to justify the finding or decision that any part of the claim of said Banks passed by mesne conveyances to any defendant or defendants residing in the town of Johnsville (pp. 32, 66).

*i.* Neither the evidence nor the agreed statement of facts justifies the finding or decision that plaintiff at the time the action was commenced was not the owner of nor entitled to the possession of the land occupied by the defendants (p. 34), but they both show on the contrary that plaintiff is and was at the time of the commencement of this action the owner of and entitled to the possession of all the premises described in the complaint of plaintiff herein.

### III. Argument.

#### 1. *No Adverse Possession.*

To constitute adverse possession to land in this State it must be under *claim of title exclusive of every other right*, and all taxes assessed upon the land must be paid upon the disputed premises for the period of five years under such claim of title by the party claiming adverse possession.

C. C. P., Secs. 321, 322, 323, 324, 325.

All taxes on the whole land included in the patent were paid by the Sierra Buttes Company,

from the date of the patent until 1888 (p. 48), and the defendants have failed to show in what manner the defendants paid taxes on their improvements, by producing the exhibit required of them by the agreed statement (p. 63).

It may fairly be presumed that their improvements were assessed as on land belonging to the Sierra Buttes Company, thus recognizing the title to the land. At all events, not having paid all or any taxes assessed on the land, they could not have adverse possession.

C. C. P., Sec. 325.

*O'Connor vs. Fogle*, 63 Cal., 9.

*Unger vs. Mooney*, 63 Cal., 586.

*Webb vs. Clark*, 65 Cal., 56.

*Ross vs. Evans*, 65 Cal., 439.

*McNoble vs. Justiniano*, 70 Cal., 395.

*Reynolds vs. Willard*, 80 Cal., 605.

## 2. Tenancy—Admission of Title.

The California Code expressly makes all possession of land by third parties to be *in subordination to the legal title by presumption*, unless it is shown to be adverse (C. C. P., Sec. 321); and it is a well settled rule of decision, that a tenancy arises by implication, not only in cases where rent has been paid and accepted, or possession taken by express permission of the owner, but also where possession

of another's land is taken under circumstances which do not negative, and are consistent with an implied permission or consent of the owner to the occupancy.

*Gay vs. Mitchell*, 35 Ga., 139.

*Dwight vs. Cutler*, 3 Mich., 566.

*Conover vs. Conover*, 1 N. J. Eq., 403.

*Dell vs. Gardner*, 25 Ark., 134.

*Smith vs. Houston*, 17 Ala., 111.

*Haight vs. Greer*, 19 Cal., 113.

*Jackson vs. Mowry*, 30 Ga., 143.

*Logan vs. Lewis*, 7 J. J. Marsh., 6.

*Hanks vs. Price*, 32 Gratt., 107.

*Grove vs. Barclay*, 106 Pa. St., 155.

*Oakes vs. Oakes*, 16 Ill., 106.

*Keyes vs. Hill*, 30 Vt., 759.

*Church vs. Imp. Gaslight Co.*, 6 Ad. and E.,  
154.

When one enters upon the land of another, by permission of the owner for an indefinite period, though without the reservation of any rent, he is by implication of law, a tenant at will.

*Larned vs. Hudson*, 60 N. Y., 104.

*Doe vs. Baker*, 4 Dev., 220.

*Jones vs. Shay*, 50 Cal., 508.

One who enters upon the land of another as a squatter, not claiming any title, and whose posses-

sion is simply acquiesced in and not objected to the owner, becomes a tenant at will of the owner, by implied consent.

*Gay vs. Mitchell*, 35 Ga., 139.

*Stamper vs. Griffin*, 20 Ga., 312.

*Smith vs. Houston*, 16 Ala., 111.

*Weaver vs. Jones*, 24 Ala., 420.

In this case the entry was not only without objection from the owner, but was made *with the understanding that there was no objection* thereto provided there was no interference with the owner's use or enjoyment of his property, and for the occupant to retain possession, *against the will of the owner*, would be a clear violation of the implied understanding and agreement, under which the entry was made, as it would interfere with the enjoyment of the absolute rights of the owner of the property; so that on principle the defendants who did not ask express permission to enter, became tenants at will of the Sierra Buttes Company, as well as those who entered by its express permission.

The learned Judge who decided the cause in the Circuit Court while admitting the well settled general principle that a tenant is estopped to deny his landlord's title (pp. 80-81), insists that the rule does not apply here because the parties acted under a mutual mistake of law as to the lessor's title, and

the parties paying rent were in possession at the time of the payment (pp. 80–81). But the learned Judge has failed to consider that these exceptions only apply *where the tenant himself claims under a title in fact paramount to that of the lessor*, and that the lessor's title is sufficiently established by a voluntary admission and recognition thereof as against a tenant *who shows no better right*.

It is the settled rule of law in this State that while an inadvertent acknowledgement of plaintiff's title by a tenant already in possession does not estop him from *showing a paramount title in himself or in a third person under whom he claims*, yet a verbal lease or recognition of plaintiff's title under a permissive tenancy is still *prima facie* and sufficient evidence of title in the landlord, unless ownership or possession under a *paramount title* is proved by the defendant, who has the burden of proof to show such title for his defense against the action of the landlord for possession.

*Peralta vs. Ginochio*, 47 Cal., 460.

*Abbey Homestead Asso. vs. Willard*, 48 Cal.,  
618.

In this case, there being no pretense of paramount title in the defendants, and there being no privity of title between the Government of the United States and settlers, *who are not mining*

*claimants*, upon lands *which are confessed to be mineral* (p. 28), and to which, therefore, no title can be acquired under the townsite act, or in any other way than by *mineral location* and payment, pursuant to the mining laws of the United States (*Defferback vs. Hawke*, 115 U. S., 392), it follows that the recognition by defendants of the title of the Sierra Buttes Co. is sufficient proof of that title, and plaintiff is entitled to recover possession as the undoubted assignee of that title, against all of the defendants who assumed the position of tenants at will of his vendor.

The learned Judge, in his opinion, says the plaintiff in ejectment must recover upon the strength of his own title (p. 82). True. But he appears to have overlooked the rule that the strength of plaintiff's title is made out by proof of a tenancy of the defendant under him, unless the tenant can show himself properly under the protection of a paramount title.

It is further to be considered that there is nothing in the record to indicate that there was any prior adverse possession or claim of title by any of the defendants specified as having paid rent to the Sierra Buttes Company in 1883 (p. 47), and their prior possession must be presumed to have been in subordination to the title of the patentee (Sec. 821, C.

C. P.) But the learned Judge seems to have overlooked the admitted fact that all of the remainder of the defendants *entered into possession in the first instance*, since 1883, with the express or implied permission of the Sierra Buttes Co. (p. 47), and thereby became estopped to deny its title, never having surrendered the possession received by its permission.

### 3. *Construction of Revised Statutes.*

The opinion of Judge Hawley sustains the contention that no patent issued since the passage of the Revised Statutes can include more than 300 feet of surface on each side of a quartz ledge, although the application and survey were made under the law of 1866, and regardless of what showing might have been made to the Land Department to sustain a larger grant under the law of 1866. He construes Sec. 2326 of the Revised Statutes as to the limitation of extent of surface claims, to be retroactive, and applicable to claims located prior to May 10th, 1872.

This position violates settled rules of construction.

“ *Courts uniformly refuse to give to statutes*  
 “ *a retrospective operation, whereby rights pre-*  
 “ *viously invested are injuriously affected, unless*  
 “ *compelled to do so by language so clear and pos-*

“itive as to leave no room to doubt that such was  
“the intention of the Legislature.”

*Chew Hong vs. United States*, 112 U. S., 536.

*Auffmordt vs. Rasin*, 102 U. S., 620.

“Even though the words of a statute are broad  
“enough in their literal extent to comprehend ex-  
“isting cases, they must yet be construed as applic-  
“able only to *cases that may hereafter arise*, unless  
“the language employed expresses a contrary in-  
“tention in unequivocal terms.”

Twenty Per Cent. Cases, 20 Wall, 179–189.

The express reservation of rights accrued under former laws is decisive against the construction made by the Court.

U. S. Rev. Stat., Secs. 2328, 5597.

Sec. 2328 provides that “*applications for*  
“*patents for mining claims under former laws may*  
“*be prosecuted to a final decision in the General*  
“*Land Office; but in such cases where adverse*  
“*rights are not effected thereby patents may issue*  
“*in pursuance of the provisions of this chapter;*  
“and all patents for mining claims upon veins or  
“lodes heretofore issued shall convey all the rights  
“and privileges conferred by this chapter, where  
“no adverse right existed on the 10th day of  
“May, 1872.”



Sec. 5597 expressly reserves all accrued rights from the operation of the repeal of the acts embraced in the revision, and provides that “all rights and liabilities under said acts shall continue and be enforced in the same manner as if said repeal had not been made.”

#### 4. *Collateral Attack Upon Patent.*

It is conceded that a patent for lands which have been expressly reserved by Congress, or which have been previously granted, or to the granting of which the Land Department has been given no jurisdiction whatever, is absolutely void, and may be shown to be such by a mere possessor of the land in an action of ejectment. Such are all of the cases cited and relied upon in the opinion of the learned Judge, who decided this case in the Circuit Court.

But the rule is clearly otherwise in such a case as the present where the lands confessedly belonged to the Government and were not reserved from grant, and where the Land Department has general power under the law to issue patents therefor, and to determine the qualifications of applicants, and all questions as to their compliance with conditions precedent to the grant.

The rule in such cases is that *if, upon any state*

*of facts, a patent might have been lawfully issued to the patentee, his title cannot be questioned collaterally in an action at law between private parties, but the Court will presume that the proper facts existed.*

*Moffat vs. U. S., 112 U. S., 24, 32.*

If the plaintiff in error is right in the contention that a patent confirmatory of an application made under the law of 1866, is not subject to the law limiting the extent of surface locations made since May 10th, 1872, it is clear that there might be a state of facts upon which the Land Department could lawfully issue the patent in question. Indeed, all that was necessary to sustain the patent was for the Land Department to be satisfied of the truth of the allegations and proofs made before it. The application for the patent alleged to the Land Office a *full compliance with the Act of 1866*, and represented that the applicants had, *prior to that date*, occupied and improved the land applied for in accordance with the diagram of survey presented, which was alleged to be "*so extended as to conform to the rules of said mining district.*" The affidavit of Wm. Letts Oliver, filed in the Land Office, alleged possession and occupation by the Mammoth Company, as the alleged successor in interest of Thompson and McGee, of all the land

applied for, and the affidavit of R. M. Wilson showed, to the satisfaction of the Land Office, that no rules were in existence to prevent such extent of occupation, and *there haviny been no adverse claim to any part of the land applied for* during the period fixed by law for such claim, the Land Office evidently took the application of Thompson and McGee and the proofs before it as true, and *adjudged that the extent of surface claimed was a "reasonable quantity for the convenient working of the vein, as fixed by local rules,"* within the true intent and meaning of Sec. 4 of the Act of 1866, as appears from the granting of the certificate of purchase and patent to the Mammoth Company for all the ground claimed by Thompson and McGee and by the Mammoth Company, as their alleged successor in interest.

The allegations made in the application for the patent, that all the land applied for had been occupied in accordance with the diagram presented, and that the said diagram was "*so extended as to conform to the rules of said mining district,*" and the failure of any person to contest such allegations during the period of notice of the application, so confirmed the right of the applicants to all the land applied for, that the allegations of that petition could no longer be questioned, and the Land

Department was justified in finding them to be true, and issuing the patent as applied for. The constructive occupation under the location of the mill site, and particularly under the previous survey, which was of itself a sufficient location of the whole ground, in compliance with the general custom of miners as to the marking of boundaries, to give a constructive occupation, in the absence of local rules forbidding it (*English vs. Johnson*, 17 Cal., 118; *Table M. and T. Co. vs. Stranahan*, 20 Cal., 210, 211; *Id.*, 21 Cal., 551; *Id.*, 31 Cal., 387) was sufficient to sustain the allegations of the petition; but whether so or not, the action of the Land Department or its patent cannot be controlled by any counter-averment or proof of facts contrary to those which appeared in the record before it.

The Land Department having jurisdiction to grant a patent for mineral land, upon proof of a location and occupation conforming to the application in compliance with local rules, the patent issued operates to *convey the whole title of the Government*, and the issuance of the patent is a *conclusive adjudication* by the Land Department of the fact of such a location and occupation as will support the patent, and of the absolute sufficiency of the compliance by the patentee with all conditions precedent to the issuance of the patent, as

against a collateral attack in ejectment by defendants not in privity with the Government.

*Aurora Hill Con. M. Co.* vs. *85 M. Co.*, 34 Fed., 515.

*St. Louis Smelting Co.* vs. *Green*, 4 McCrary, 232, 239.

*St. Louis Smelting Co.* vs. *Kemp*, 104 U. S., 636.

*Steel* vs. *Smelting Co.*, 106 U. S., 447.

*Wright* vs. *Dubois*, 21 Fed., 794.

*Johnson* vs. *Towsley*, 13 Wall., 83.

*French* vs. *Fyan*, 93 U. S., 72.

*Quinby* vs. *Conlan*, 104 U. S., 426.

*Erhhart* vs. *Hagaboom*, 115 U. S., 67.

*Bagnall* vs. *Broderick*, 13 Pet., 450.

*Scheimer* vs. *Conway*, 23 How., 235.

*Hoofnagle* vs. *Anderson*, 7 Wheat 212.

*Cowell* vs. *Lammers*, 21 Fed. Rep., 204.

*Sanford* vs. *Sanford*, 139 U. S., 642.

The case of *Parley's Park Silver Mining Company* vs. *Kern*, 130 U. S., 256, cited by Judge Hawley, decides that the existence and operation of local rules and customs of miners limiting the extent of a location, is a *question of fact* over which the Land Office had jurisdiction. The location in that case was made after May 10th, 1872, and was of course subject to the provisions of the law of 1872.

Whether a mining rule was in force at a given time, is a question of fact.

*Harvey vs. Ryan*, 42 Cal., 626.

We submit that the Court could not properly be turned into a Land Office, to determine what mining rules or customs, if any, were in existence at the date of the locations upon which the Mammoth patent was obtained, or whether the laws and customs of miners permitted the occupation of such surface as was taken by Thompson and McGee, or whether the quantity taken was, in fact, reasonable or otherwise; and it could not undertake to limit or control the operation of this patent upon any such grounds, especially in favor of mere intruders who have no rights under the Government.

His Honor, Judge Hawley, insists that jurisdictional facts may be inquired into, and that local mining rules limit the authority of the Land Department to issue a patent in accordance therewith. But he apparently overlooks the consideration that the Land Department itself is authorized to determine the existence and contents of local rules. Such rules can only constitute *a limitation upon the authority* of the Land Department when the Land Department itself finds that they *positively limit the extent of a surface location* to a smaller quantity than that applied for. But it found the contrary in this case, and its finding is conclusive.

The evidence before this Court shows clearly that there was no uniform rule or defined custom *positively limiting the extent of surface*, but the miners occupied what land they chose in the working of their mines. Whatever may have been the rules in 1851, in respect to which the affidavits conflict (pp. 58, 59, 60, 61), it is certain that in 1867 there was no rule or custom in force to prevent the *survey and actual location of boundaries* made prior to the application for the patent, so as to include the old millsite and timber location, and connect it with the lode, tunnels and tramway. The Government was certainly not defrauded by being paid \$5 an acre for the ground applied for.

The appropriation made by the survey of 1867 must be presumed to be reasonably consistent with the local and general usage of miners in the district.

It is certain that that survey did not interfere with any rights existing at its date; nor with any location of mining ground made prior or subsequent to the date of the patent.

The decisions of the Supreme Court of California prescribing a rule for all places in the State, where there is no local rule *limiting the extent of surface*, and legitimizing a marking of surface

boundaries to any reasonable extent not inconsistent with local rules or with the general usage of miners, and not amounting to a monopoly, have the force and effect of a *local rule* applicable to each locality not otherwise providing; and a reasonable quantity of surface ground as fixed by a marking of boundaries in accordance with those decisions in a locality where no local rule limits the extent of surface occupation, is clearly a "*reasonable quantity of surface ground as fixed by local rules,*" within the meaning and intent of the Act of 1866. The local rules in such case must be construed in the light of the general custom, and as qualified by it.

It does not follow that *in the absence of local rules limiting the amount of surface occupation*, there could be no grant of any surface under the Act of 1866 for want of any rule of tenure; but if neither local rules nor general custom limited extent of surface, the Land Department would have clear authority to determine, in view of all the facts, *what constituted a reasonable quantity of surface ground*, and to grant a patent accordingly, upon a showing to it that the land had been occupied as provided in the first section by an Act, which showing was made to it by the application for this patent and the affidavits filed thereunder. Its decision upon the matter is final.



Judge Hawley in his decision of this case appears further to have overlooked the well settled principle that where the authority of a tribunal depends upon facts *in pais*, its determination of the existence of facts giving it authority is conclusive.

He cites the case of *Smelting Co. vs. Kemp* (104 U. S., 636), as upholding the position that jurisdictional facts may be questioned. That case clearly recognizes the distinction between cases where the Land Department has power to make grants of land belonging to the government, and cases where the lands are not public property, or had been previously disposed of or reserved from sale, or the sale thereof had not been authorized by law, so that the Land Department could have no jurisdiction over the subject matter of the grant of such lands under any circumstances to any person, and affirms the rule that in the former class of cases the patent cannot be assailed collaterally in an action at law, while in the latter class of cases it may be so assailed. Yet the latter class of cases is treated as exceptional, and the Court in speaking of the exception that "if the patent be issued without authority, it may be collaterally impeached in a court of law," proceeds to say:

"This exception is *subject to the qualification that*  
" *when the authority depends upon the existence of*

“ *particular facts, or upon the performance of cer-*  
 “ *tain antecedent acts, and it is the duty of the Land*  
 “ *Department to ascertain whether the facts exist or*  
 “ *the acts have been performed, its determination is*  
 “ *as conclusive of the existence of the authority,*  
 “ *against any collateral attack, as is its determina-*  
 “ *tion upon any other matter properly submitted to*  
 “ *its decision.*”

That case proceeds further to hold that the records of the Land Office are not admissible to impeach the validity of a *mineral patent*, or to show that too much mineral land was granted to one applicant under the law; that the judgment of the Land Department upon the sufficiency of the proceedings upon which the patent was issued is “ *not open to contestation*. If, in issuing a patent, “ *its officers took mistaken views of the law, or drew* “ *erroneous conclusions* from the evidence, or acted “ *from imperfect views of their duty, or even from* “ *corrupt motives, a court of law can afford no* “ *remedy to a party alleging that he is thereby* “ *aggrieved. He must resort to a court of equity,* “ *and even there his complaint cannot be heard,* “ *unless he connect himself with the original source* “ *of title, so as to be able to aver that his rights are* “ *injuriously affected by the existence of the patent;* “ *and he must possess such equities as will control* “ *the legal title in the patentee’s hands.*”

The Court proceeds further to *presume conclusively, in support of the patent*, that the patentee had properly acquired by purchase from proper locators, all the lands patented, though patented in one body, to one person, who could not locate so much land, and holds that the law for the sale of mining ground, which affords an opportunity for protest during the period of notice of application for the patent, and provides for the adjudication of adverse claims, presents “*more cogent reasons in cases where a patent for such ground is relied upon to maintain the doctrine which we have declared that it cannot be assailed in a collateral proceeding than in the case of a patent for agricultural land.*”

*Steel vs. Smelting Co.* (106 U. S., 452), was a case of conflict of a mineral patent with a townsite claim, and it was held that the mineral patent could not be collaterally assailed in an action of ejectment against the townsite claimants. The Court says:

“It is among the elementary principles of law, that in actions of ejectment the legal title must prevail. *The patent of the United States passes that title.* Whoever holds it must recover against those who have only unrealized hopes to obtain it, or claims which it is the exclusive province of

“ a court of equity to enforce. \* \* \* That instrument must first be got out of the way, or its enforcement enjoined before others having mere equitable rights can gain or hold possession of the land it covers.”

In each of the following cases a mineral patent was sustained in an action of ejectment, as against townsite claimants, though the townsite existed at the date of the patent.

*Deffeback vs. Hauke*, 115 U. S., 392.

*Sparks vs. Pierce*, 115 U. S., 408.

*St. Louis vs. Smelting Co.*, 4 McCrary, 237-246.

In the case of *Sparks vs. Pierce*, the Court says: “ Here it does not appear that any effort had been made, either by the authorities of the town or by the Probate Judge of the county, or by any one else, on behalf of the occupants of the town, or by the defendants or their grantor, to acquire the legal title. The case presented, therefore, is that of occupants of the public lands *without title*, and without any attempt having been made by them, or by any one representing them, to secure that title, resisting the enforcement of the patent of the United States, on the grounds of such occupation. Mere occupation of the public lands and improvements thereon, give no vested rights

therein, as against the United States, and consequently not against any purchaser from them. To entitle a party to relief against a patent of the government, he must show a *better right to the land than the patentee*, such as in law should have been respected by the officers of the Land Department, and being respected, would have given him the patent. *It is not enough to show that the patentee ought not to have received the patent.* It must affirmatively appear that the claimant was entitled to it, and that in consequence of erroneous rulings of those officers on the facts existing, it was denied to him. *Bohall vs. Dilla*, 114 U. S., 51."

In the case at bar there is no ground for a pretense of any better right of the defendants to the land in controversy than that of the patentee of the Government. The rights of the applicant for the patent were determined by the requisite notice without adverse claim long before the existence of a single village lot in Johnsville. Banks could not by merely squatting on confessedly mineral land "for building and agricultural purposes" before the issuance of the mineral patent, initiate any rights whatever against the Government of the United States or its grantees of mineral land. The defendants have proved no rights under Banks, and have shown no title whatever in themselves. They have no

standing as against the grant of the Government title.

5. *Conclusion.*

It is not necessary to discuss in detail all of the specifications of error, as they are involved in the questions already discussed. If the positions taken by the plaintiff in error in the foregoing argument, either as to the proof of plaintiff's title by the tenancy of defendants, or as to the proper construction and effect of the Revised Statutes, and as to the non-assailibility in this action of the mineral patent under which plaintiff claims, is correct, it is evident that the judgment should be reversed and that judgment should be ordered to be entered in favor of the plaintiff in error, since all the facts are ascertained under stipulation of the parties as shown by the bill of exceptions (pp. 43 to 63), so that there is no occasion for a new trial. It is respectfully submitted that such is the proper determination to be made of this case.

H. L. GEAR.

Attorney for Plaintiff in Error.

No. 28.

---

IN THE

# United States Circuit Court of Appeals.

NINTH CIRCUIT.

---

**April Term, 1892.**

---

WM. H. LAKIN, Plaintiff in Error,

VS.

J. H. ROBERTS, et al., Defendants in Error,

---

**SUPPLEMENTAL BRIEF FOR PLAINTIFF IN ERROR.**

---

H. L. GEAR,

*Attorney for Plaintiff in Error.*

---

FILED

APR 18 1892





IN THE  
United States Circuit Court of Appeals

FOR THE NINTH CIRCUIT.

---

WILLIAM H. LAKIN,  
*Plaintiff in Error,*  
vs.  
J. H. ROBERTS ET AL.,  
*Defendants in Error.*

---

---

SUPPLEMENTAL BRIEF FOR PLAINTIFF.

1. *Construction Sec. 2320, U. S. Rev. Stat.*

Sec. 2322, as to rights of possessors must be considered. Also Sec. 441, 453, 458, regulating powers of Land Department as to patents.

See also *U. S. Land Association vs. Knight* (142 U. S.), and concurring opinion of Justice Field as to authority of Land Department and conclusiveness of Government survey and patent.

Rules of Land Department issued June 10th, 1872, and rules since issued, uniformly construe statute as regulating *width of surface* of old locations prior to 1872, by mining rules and customs.

Decisions of Land Department treat prior applications under law of 1866, as *an appropriation of the land surveyed as applied for*, and hold that patent is to issue under law of 1872, so as to confer rights thereby given to other lodes in the surface applied for.

Sickel's Mining Dec., pp. 67, 184-187.

Supreme Court confirms ruling of Land Department as to mining claims prior to passage of mining laws being regulated by mining customs and rules.

*Glacier Mountain Silver Mining Co. vs. Willis*, 127 U. S., 471, and cases cited therein.

A location of a mining claim confers property upon the locator, and after application for a patent is made, and time for adverse claim is past, title is held in trust for applicant subject to payment for the land applied for.

*Noyes vs. Mantle*, 127 U. S., 348.

*Sullivan vs. Iron Silver Mining Co.*, decision Feb. 29, 1872.

*Dahl vs. Ranheim*, 132 U. S., 260.

*Dahl vs. Montana Copper Co.*, 132 U. S., 162.

*Butte City Smoke House Lode Cases*, 12 Pac. Rep., 858.

*Talbott vs. King*, 9 Pac. Rep., 441.

*Hamilton vs. Southern Nev. G. & M. Co.*,  
33 Fed., 562.

Rights thus accrued under a prior application and survey could not be intended to be divested by Sec. 2320, nor could the parties be relegated to a new survey, in the face of the express reservation in favor of pending applications, by Sec. 2328.

## 2. *No Ground to Assail Patent.*

If a patent for public lands of the United States subject to sale should be procured by misrepresentation of facts, and fraud in the land office, the patent is still good as to all the world as against a collateral attack in an action at law, and can only be assailed in equity by the Government or one showing *a better right* to the land patented. No stranger to the title can ever assail it.

*Sandford vs. Sandford*, 139 U. S., 642.

*Field vs. Seabury*, 19 How., 333.

*Wright vs. Dubois*, 21 Fed., 794.

*Turner vs. Donnelly*, 70 Cal., 597.

*Moore vs. Wilkinson*, 13 Cal., 478.

*Yount vs. Howell*, 14 Cal., 460.

*Chapman vs. Quinn*, 56 Cal., 266.

*Churchill vs. Anderson*, 56 Cal., 56.

*Doll vs. Meador*, 16 Cal., 325.

The patent is conclusive evidence of the *validity of the location* and of *proper notice of application* and of all precedent acts.

*St. Louis Smelting Co. vs. Greene*, 4 McCrary, 232, 239.

*Aurora Hill Mining Co. vs. S. M. Co.*, 34 Fed., 515.

*Talbott vs. King*, 9 Pac. Rep., 439.

*Butte City Smoke House Lode Cases*, 12 Pac. Rep., 858.

All the land patented might have been lawfully granted as placer ground combined with a lode claim, for less money than was actually received by the Government, which obtained \$5 per acre for the whole land patented, but under the law of 1872 could have sold the ledge and 25 feet adjacent thereto for \$5<sup>a</sup> per acre, *and in the same patent* could have sold all the rest of the land as placer ground at \$2.50 per acre. Surely, neither the Government nor any other person has cause to complain of the grant made to the patentee.

Sec. 2333, U. S. Rev. Stat.

*All jurisdictional questions of fact were conclusively adjudicated* by the patent issued under the facts appearing to the Land Office, and no contrary jurisdictional fact can be shown to impeach the record.

*Smelting Co. vs. Kemp*, 104 U. S., 636.

*Irwin vs. Schreiber*, 18 Cal., 505.

*Lessee vs. Astor*, 2 How., 339.

*In re Grove St.*, 61 Cal., 453.

*Ex parte Sterne*, 77 Cal., 163.

The United States Survey and patent of public lands are conclusive upon the Court in an action of ejectment.

*U. S. Land Asso. vs. Knight*, 142 U. S.

See especially concurring opinion of Justice Field.

*Moore vs. Wilkinson*, 13 Cal., 478.

*Yount vs. Howell*, 14 Cal., 464.

Parley's Park Silver Mining Company (130 U. S., 256), relied upon by Judge Hawley, was a *suit in equity* by a party claiming as a *locator* of mining ground, against a patentee, where it appeared that the *facts* were correctly presented to the Land Office, and it was claimed that they erred in their construction of the local mining laws. The Court held that they did not err, but correctly decided the question before them, and that the question as to whether rules continued in force was a *question of fact* within their jurisdiction. If they had erred upon a *question of law* before them, the patent would have been controlled *in equity in favor of the owner of the better title*.

No decision upon a matter of fact, and *no decision upon a mixed question of law and fact*, can ever be considered, *even upon a proceeding in equity* to contest a patent. The patent can only be controlled *upon a legal construction of the case actually made in the Land Office.*

*Quimby vs. Conlan*, 104 U. S., 420.

*Sandford vs. Sandford*, 139 U. S., 642.

Where, as here, there is no proceeding in equity, but a pure case at law, no erroneous decision of the Land Office as to any matter of fact or law, within the purview of its jurisdiction, or to the existence of any jurisdictional fact *in pais*, whether mixed with questions of law or not, can be considered in favor of a stranger to the title.

*Aurora Hill Con. M. Co., vs. 85 M. Co.*,  
34 Fed., 515, and cases before cited.

Respectfully submitted.

H. L. GEAR,  
Attorney for Plaintiff in Error.

No. 28.

---

IN THE  
UNITED STATES CIRCUIT COURT OF APPEALS.

NINTH CIRCUIT.

---

**April Term, 1892.**

---

WM. H. LAKIN, Plaintiff in Error,

VS.

J. H. ROBERTS, et al., Defendants in Error.

---

BRIEF FOR DEFENDANTS IN ERROR.

---

GOODWIN & GOODWIN,

*Attorneys for Defendants in Error.*

---

FILED  
APR 16 1892





IN THE  
United States Circuit Court of Appeals.  
NINTH CIRCUIT.

WM. H. LAKIN,

*Plaintiff in Error,*

*vs.*

J. H. ROBERTS, *et al.*,

*Defendants in Error.*

Statement of the Case.

The statement of the case contained in Brief of Plaintiff in error is correct in the main. Plaintiff claims title to the land by virtue of a patent of the United States issued to the Mammoth Gold Mining Company on the 18th day of May, 1877. The patent on its face purports to convey 4,100 feet of a gold-bearing quartz lode, with 252 and 95-100 acres of surface ground. The line of the lode as indicated on the patent, as well as located and marked upon the surface of the claim, is in a straight line along the west or northwest boun-

dary of the patented tract and within fifty feet of said boundary. And all of said surface tract, except said strip of 50 feet in width, appears from the patent to be, and in fact is, on the east or southeast of said lode and extends some three-fourths of a mile therefrom. The patent purports to have been issued under the provisions of the revised statutes. The portion of the patented premises occupied by the defendants and in controversy here is all one thousand feet distant from the lode line, and 200 feet from Jamison Creek (p. 46). In 1883, for the first time, the Sierra Buttes Gold Mining Company demanded of the citizens of Johnsville that they should pay a nominal rent to the company for the land occupied by them as town lots. The defendant Dolly and *several other* defendants paid from one to five dollars each at that time. At no time prior to said date did any other person or company, claiming to own the said land under said patent, demand any rent of the citizens of said town, nor were any rents thereafter demanded until by this plaintiff in the spring of 1889. That those of defendants, *if any*, who entered upon the land subsequent to 1883, either obtained permission of said Sierra Buttes Company, or entered upon the land within the limits of said town, with the understanding that the said company did not object to

their occupancy so long as the enjoyment of its rights in the premises were not interfered with (p. 33).

But who, other than Dolly, paid rent, or whether or not any person entered after 1883, and if so, who or how many entered with the express permission of the Sierra Buttes Company, or how many under the general repute that the Sierra Buttes Company did not object, does not appear from the record. And the finding on this point is not attacked in plaintiff,s specifications.

On the 17th day of June, 1876, one John Banks entered upon a portion of the premises in dispute and located the same for resident and farming purposes, and the findings of fact and agreed statement show that whatever interest he acquired thereby passed by mesne conveyances to a portion of said defendants.

### **ARGUMENT.**

Plaintiff contends that defendants became tenants at will by reason of the payment of the nominal rent in 1883, and virtually asks the Court to presume therefrom that they entered the premises in pursuance of such payment, or if the entry was prior thereto that it be deemed to have been permissive. The authorities, cited to which we have access, do not support this contention.

Haight vs. Greer, 19 Cal. 113 was ejectment. The only evidence was in substance that plaintiff's testator owned the premises prior to defendant's entry; that defendant entered under him and now claims the property and is in possession. Also that plaintiff held letters testamentary. The Court said that was sufficient prima facie to maintain the action. Grace vs. Barclay 106 Penn St. 155 was in assumpsit and the Court held upon the facts that the jury might find the defendant liable on one of the three grounds following: For use and occupation, for storage, or for obstruction of plaintiff's use of property. Title to the realty was not in issue, nor was the doctrine of estoppel discussed.

Larned vs. Hudson, 60 N. Y. 104, was ejectment. The question in the case was whether defendant entered under license or by tenancy. There was no dispute as to title, nor as to the permissive entry.

Jones vs. Shay 50 Cal. 508 was forcible entry and detainer. Plaintiff was in peaceable, actual possession under contract at the time of forcible entry. The Court held that under that state of facts, plaintiffs, though paying no rent, was a tenant at will, and could therefore maintain that character of action. The other authorities cited are not at hand.

We do not question the proposition that a tenant receiving possession of the land of another under a contract to hold it for an indefinite period, becomes a tenant at will, and if not within certain exceptions is estopped from setting up title during such holding. But the facts of this case fall far short of bringing defendants within the general rule.

“Estoppels are odious because thereby a man “is concluded to say the truth, and therefore the “law does not favor them.”

Franklin vs. Merida, 35 Cal. 558.

A tenancy at will can not arise without an actual grant or contract.

1st Washburn on Real Pro. 504.

Blum vs. Robertson, 24 Cal. 145.

That O. B. Dolly and “*several other defendants*” paid a nominal rent in 1883 is the fact relied upon to create the estoppel. All else necessary to make the contract, the entry into possession at that time, or if prior, that the entry was in subordination to plaintiff’s title, will be conclusively presumed says plaintiff. This is urged in face of the finding of the Court that Defendant Dolly and several other defendants, were in possession of their several lots when such rent was paid. That Banks located the plat in 1876 with all the

notoriety practicable, that he occupied it immediately by erecting large buildings for business and trade thereon; that the town grew to its present dimensions in population within three years from that time. That whatever right Banks had acquired passed by mesne conveyances to some of defendants. That no one objected to their occupancy or questioned their right so to occupy the same until 1883; that the location and occupancy bordered on, and from the record, recognized the boundaries of the old Mammoth Company as then notoriously held by said company.

But plaintiff says Banks did not, nor could those entering and holding under him thus acquire any rights or possessions entitled to respect. To this there are two answers:

1st. The rights of neither Banks nor the defendants holding under him are in issue here. Plaintiff must recover, if at all, upon the strength of his own title.

2nd. The law contemplates the building of just such towns as Johnsville upon mineral lands adjacent to valuable mines.

Weeks on Mineral Lands, Secs. 221-2.

These facts can leave no room for presumptions in support of the estoppel upon which plaintiff relies. The burthen is on him to show clearly, not

only the contract of tenancy, but also that defendant took possession under it.

Tewksbury vs. Magraff, 33 Cal., 237.

Franklin vs. Merida, 35 Cal., 566.

As to the defendants who entered since 1883, if any, some entered by permission and others under the common repute that the Sierra Buttes Company would not object. Long prior to 1883, the town was of the same size as now, with all of its streets, blocks and lots, as shown by the plat, and occupied by the same number of people. (p. 32) And it is admitted that during all of this time, none of the said town was possessed by plaintiff or his grantors. It would necessarily follow that those who have entered since 1883, if any, simply took the place of the prior occupants who held under Banks, and it matters not whether they entered under permission of the Sierra Buttes Company or under the general repute of the said Company's likes and dislikes in the matter. But who and how many entered by permission, and how many under general repute? It devolves upon plaintiff to show these matters, but we find the record entirely silent in relation to them. They also would have to be presumed to enable the Court to render judgment in accordance with plaintiff's contention.

But it does clearly appear that whatever recognition of plaintiff's title was made was under the mistaken idea that plaintiff had title, and whatever rent was paid was by parties already in possession, so in either case defendants are brought clearly within the exceptions to the general rule, as laid down in

Tewksbury vs. Magraff, 33 Cal., 341.

Franklin vs. Meridia, 35 Cal., 575.

Schultz vs. Elliott, 11 Humph., 187.

Miller vs. McBrier, 1 Serg. & R., 382.

Swift vs. Dean, 11 Vt., 323.

Carter vs. Marshal, 72 Ill., 609.

The contention that to defeat plaintiff's title defendants must show title in themselves has no warrant in reason and no fair construction of the authorities will support it.

Peralta vs. Guirchino, 47 Cal., 460, cited by plaintiff, holds that title in plaintiff cannot be defeated by averment, but proof is required on defendant's part; and that the plaintiff, by producing a lease to defendant, makes a prima facie case. The other language of the decision must be construed in the light of the issues in the case. The action was unlawful detainer. Plaintiff alleged that defendant held as her tenant, and defendant



claimed that he was holding as the assignee of a lease from other parties.

*Abbey Homestead Ass. vs. Willard*, 48 Cal., 618. was ejectment. The defense was adverse possession. It appeared at the trial that shortly before suit was brought defendant had leased the premises of plaintiff. The learned council for plaintiff in that case conceded that "defendant " might have shown that plaintiff had no title (p. " 617), and the decision does not hold to the contrary."

In *Diffback vs. Hawk*, 115 U. S., 392, the defendant relied upon his adverse holding at the time patent was issued to defeat it. The decision is against such contention. It does hold, however, that mineral lands may be included in a townsite patent, but that the patent would be inoperative as to such as were known at the time to be valuable for their mineral.

In *Reynolds vs Iron Silver Mining Co.*, 116 U. S., 687, which is a case arising upon the exception from a Placer Patent of all known veins of rock in place bearing gold, silver, etc., and in which defendants relied solely upon the fact that the ledge was known to exist at the time patent was issued to the Placer claimants, the Court says, in reference to one of defendant's instructions: "The

“ conflict in principal between the instructions  
“ asked and refused, and those given by the  
“ Court, is marked and easily discerned and pre-  
“ sents the only question in the case. Its primary  
“ form is presented by the fourth of the defend-  
“ ants requests, namely, ‘that plaintiff must re-  
“ cover on the strength of his own title.’ This is  
“ the fundamental principle on which all actions  
“ of ejectment or actions to recover the posses-  
“ sion of real estate rest even where the plaintiff  
“ recovers on proof of priority of possession, it is  
“ because, in the absence of any title in any one  
“ else, this is evidence of title in plaintiff. If  
“ there is any exception to the rule, that in an  
“ action to recover possession of land, the plain-  
“ tiff must recover on strength of his own title,  
“ and that the defendant in possession can law-  
“ fully say, until you show some title, you have  
“ no right to disturb me; it has not been pointed  
“ out to us.”

Doolan vs. Carr, 125 U. S., 620, is to the same effect. In this case the point is emphasized by the dissenting opinion of the Chief Justice, based upon the fact that defendant was so attacking the patent without showing any right in himself.

## Construction of Revised Statutes.

The patent in question is void upon its face as to all of the surface ground on the east or south-east of the lode as marked thereon, in excess of three hundred feet from the center of said lode.

The sections of the Revised Statutes in relation thereto, are as follows: Section 2318, "In all cases, lands valuable for minerals shall be reserved from sale except as otherwise expressly directed by law."

Section 2320, "Mining claims upon veins or lodes of quartz or other rock in place bearing gold, silver, etc., *heretofore located* shall be governed *as to the length along the vein or lode, by the customs, regulations and laws in force at the date of their location.* A mining claim located *after* the tenth day of May, 1872, whether located by one or more persons, may equal, but shall not exceed one thousand five hundred feet in length along the vein or lode, but no location of a mining claim shall be made until the discovery of the vein or lode within the limits of the claim located. *No claim* shall extend more than three hundred feet on each side of the middle of the vein at the surface; nor shall any claim be limited by any mining regulations to less than twenty-five feet on each side of the

“ middle of the vein at the surface, *except where*  
 “ *adverse rights existing on the tenth day of May,*  
 “ *eighteen hundred and seventy-two, render such*  
 “ *limitation necessary.*”

There should be no question as to the purpose of these provisions. They clearly restrict the sale of the precious metal mines to prescribed conditions and in distinct limited quantities. The claim must be segregated by location from the mass of mineral lands, and all conditions of the status must exist and be complied with before the Land Department has the jurisdiction to sell or the claimant the right to buy the claim in question.

In construing Section 2320 we can do no better than incorporate the clear and concise language of the learned judge who tried and decided this case in the Circuit Court, as appears in his written opinion at page 37 *et sequor*. “The entire  
 “ Section seems to be clear, definite, and certain.  
 “ It provides that all mining claims upon quartz  
 “ lodes located *prior to its* passage should be  
 “ governed as to the length of the claim along the  
 “ lode, by *customs, regulations, and laws in force*  
 “ at the date of their location; that the claims  
 “ located *after* the 10th day of May, 1872, may  
 “ equal, but shall not exceed one thousand five

“ hundred feet in length along the vein or lode.  
 “ So far the Section relates solely to the question  
 “ of the length of the lode that may be located.  
 “ It next takes up the question as to how much  
 “ surface ground will be allowed to a locator of a  
 “ quartz lode, and says that *no claim*, evidently  
 “ meaning all claims, whether coming within the  
 “ first clause relating to claims located prior to  
 “ the passage of this Section, or within the second  
 “ clause relating to locations made subsequent  
 “ thereto, ‘ shall extend more than three hundred  
 “ feet on each side of the middle of the vein at  
 “ the surface.’ Having thus expressed the extent  
 “ of the surface ground to which the locator may  
 “ be entitled, it further provides that the amount  
 “ of surface ground, shall not, in any case, be  
 “ limited by any mining regulations to less than  
 “ twenty-five feet on each side of the middle of the  
 “ vein at the surface, except where adverse rights,  
 “ existing on the 10th day of May, 1892, render  
 “ such limitations necessary.”

This construction of the statute is certainly correct, and it necessarily follows therefrom that after the passage of the Act of which this section is a part, the land department has no jurisdiction, power or authority, to issue a patent for a quartz lode to any surface ground in excess of three

hundred feet in width on each side of the center of the lode, and that any patent issued for more than that amount of surface ground is absolutely null and void, as to the excess over three hundred feet, and can be collaterally attacked in a court of law. For, as is announced by Mr. Justice Miller in delivering the opinion of the Court in *Doolan vs. Carr*, 125 U. S. 624, "There is no question as to the principal that when the officers of the Government have issued a patent in due form of law, which on its face is sufficient to convey the title to the land described in it, such patent is to be treated as valid in actions at law, as distinguished from suits in equity, subject, however, at all times to the inquiry whether such officer had the lawful authority to make a conveyance of the title. But if those officers acted without authority, if the land which they purported to convey had never been within their control, or had been withdrawn from that control at the time they undertook to exercise such authority, then their act was void, void for want of power in them to act on the subject matter of the patent, not merely voidable, in which latter case, if the circumstances justified such a decree, a direct proceeding with proper averments and evidence would be required to establish that it was avoidable and should therefore be avoided.

“ The distinction is a manifest one, although the  
 “ circumstances that enter into it are not always  
 “ easily defined. It is nevertheless a clear distinc-  
 “ tion, established by law, and it has often been  
 “ asserted in this Court that even a patent from  
 “ the Government of the United States, issued  
 “ with all the forms of law, may be shown to be  
 “ void by extrinsic evidence, if it be such evidence  
 “ as by its nature is capable of showing a want of  
 “ authority for its issue.”

The same proposition of law is announced with force and clearness in the following authorities:

- Polk Lessee vs. Wendall, 9 Crauch 87.  
 New Orleans vs. United States, 10 Pet.  
 662, 730.  
 Wilcox vs. Jackson McConnell, 13 Pet.  
 498.  
 Stoddard vs. Chambers, 2 Howard 284,  
 317.  
 Easton vs. Salisbury, 21 Howard 426-428.  
 Reichart vs. Felps, 6 Wall 160.  
 Best vs. Polk, 6 Wall, 112-117.  
 Eleavenworth Railroad vs. United States,  
 92 U. S. 733.  
 New Hall vs. Sanger, 92 U. S. 761.

Sherman vs. Buick, 93 U. S. 209.

Smelting Co. vs. Kemp, 104 U. S. 636.

Steel vs. Smelting Co., 106 U. S. 447.

Kansas Pacific Railway Co. vs. Dunmeir,  
113 U. S. 629.

Reynolds vs. Iron Silver Mining Co., 116  
U. S. 687.

In *Smelting Co. vs. Kemp*, 104 U. S. 636, the patent was regular upon its face. "unless some limitation in the law as to the extent of a mining claim which can be patented, has been disregarded." In rendering the opinion Mr. Justice Field, quoting from *Pattison vs. Winn*, 11 Wheaton 380, says, "that if a patent was issued without authority, or was prohibited by statute \* \* \* it could be impeached collaterally in a court of law in an action of ejectment." In explanation of the phrase "that if the patent be absolutely void on its face, it may be attacked collaterally, impeached in a court of law," the learned Justice, delivering the opinion of the Court, said: "It is meant that the patent is seen to be invalid, either when read in the light of existing law, or by reason of what the Court must take judicial notice of; as for instance \* \* \* that the patent is for an unauthorized amount."



This is a full recognition of the principle contended for by defendants.

In Parleys Park Mining Co. vs. Kerr, 130 U. S. 261, the question was presented whether the patent issued for a quartz lode was void because it embraced more than 200 feet in width of surface ground. In commenting upon this case Judge Hawley says (p. 39): "There it was shown " that the rules adopted on the 17th day of May " by the miners of the district, when the lode was " located, provided 'that the surface width of any " mining location shall not exceed one hundred " feet in width on each side of the wall rocks of " said lode.' But it also appeared that in antici- " pation of the Act of Congress of May 10th, " 1872 (Sec. 2326 Rev. Stat.), there was a meet- " ing of miners held in said district on the 4th day " of May, 1872, and the rules of the district were " altered and amended so as to provide that 'the " surface width shall be governed by the laws of " the United States of America,' and the Court " very properly held that in *view of the testimony* " the Land Department had a right to determine " which of these rules were in force." In other words, they held that the finding of the Land Department was *sustained by the evidence*. "What " the result of the opinion would have been if

“there had been no amendment to the mining  
“rules is made clear by the language of the  
“Court in its reference to the rules and regula-  
“tions of the miners adopted in 1870 limiting the  
“surface ground to 200 feet. Upon this point  
“the Court said: ‘Had that regulation remained  
“in existence and been in operation at the time  
“the Clara claim was located, its effect upon the  
“legality and validity of that location, at least as  
“to all the land in excess of two hundred feet,  
“could not be doubted.’”

It is a necessary conclusion that if the foregoing construction of the Revised Statute is correct and the authorities cited applicable to our contention, the patent in question, in so far as it includes ground in excess of 300 feet, on each side of the lode line as designated upon the same, was issued without authority of law, and therefore void.

We assent to the proposition that, as a general rule, courts do not favor such constructions of statutes as will make them retroactive and thereby trench upon vested rights. But in this case the matter is not left for construction; it is the express enactment of the legislative power, expressing their intent to restrict surface grants to 600 feet, in language as plain and unequivocal as it was possible to use and pay any attention to the accepted rules of rhetoric.

But the construction of Section 2320 Revised Statutes, which we urge upon the attention of the Court, does not militate against, or affect in any manner any vested right of plaintiff's grantors in the townsite of Johnsville. The only rights they had at the time of this Congressional enactment was the original Mammoth Holding, which includes no portion of the land in controversy here, and the *lode line* of the extension. For the Court finds that there was no local law or rule authorizing the possession of this tract of surface land by them, and that, as a fact, they never actually possessed it (pp. 29-30). It seems to us that it would be a perversion of every principle of law upon this subject to hold that simply by a survey of this large tract in connection with the patent proceedings, they acquired a vested right in it.

In *Deffinbeck vs. Hawk*, 115 U. S. 402, the Court says: "No reference can be had to the original statutes, to control the construction of any section of the Revised Statutes, when the meaning is plain, although in the original statutes it may have had a larger or more limited application that that given to it in the revision."

### **Local Customs, Rules Etc.**

The patent in question must be viewed by the Court in light of the fact that the local customs in

Jamison Mining District limited the amount of surface ground to be taken in connection with the quartz lode to one hundred feet on each side thereof. This is found as a fact by the Court, (p. 29) and the finding is supported by the evidence, (pp. 58, 59).

Speaking of local mining rules and regulations, the Court, in *Smelting Co. vs. Kemp*, 104 U. S. 649, through Justice Field, says: "Soon after the  
" discovery of gold in California, as is well known,  
" there was an immense immigration of gold  
" seekers into that territory. They spread over  
" the mineral regions and probed the earth in all  
" directions in pursuit of the precious metals.  
" Wherever they went they framed rules prescrib-  
" ing the conditions upon which mining ground  
" might be taken up, in other words, mining  
" claims be located, and their continued possession  
" secured. These rules were so framed as to  
" give to all immigrants absolute equality of right  
" and privilege. The extent of ground which  
" each might locate, that is, appropriate to him-  
" self, was limited, so that all might, in the homely  
" and expressive language of the day, have an  
" equal chance in the struggle for the wealth  
" there buried in the earth. \* \* \* The rules  
" and regulations originally established in Cali-

“fornia, have in their general features been  
 “adopted throughout all the mining regions of  
 “the United States. They were so wisely framed  
 “and fair in their operation, that they have not,  
 “to any great extent, been interfered with by  
 “legislation, either state or national.

“In the first mining statute passed July 9th,  
 “1866, they received the recognition and sanction  
 “of Congress, as they had previously the legisla-  
 “tures of the states and territories in which  
 “mines of gold and silver were found.” This is a  
 clear and most authoritative statement of the  
 origin, existence and general scope of an immense  
 body of the laws of this land.

In the case of *Morton vs. Solambo C. M. Co.*,  
 26 Cal. 533, in discussing the potency of these  
 laws, the Court say: “Having received the sanc-  
 “tion of the Legislature, they become as much a  
 “part of the law of the land, as the common law  
 “itself, which was not adopted in a more solemn  
 “manner.

Would a custom limiting lode locations to  
 twenty or thirty feet along the vein, and allow-  
 ing  $\frac{3}{4}$  of a mile of surface, and that being, all  
 but fifty feet, on one side thereof, ever called forth  
 such eulogies as these above quoted. We say no.  
 It was because of this high estimate of the justice

and efficacy of these laws, as known to exist and interpreted by the Courts, that Congress made them the tenure by which gold mines should be held and sold.

Section 2 of the Act of 1866 provides, "That  
 " whenever any person or association of persons,  
 " claim a vein or lode of quartz or other rock in  
 " place bearing gold, silver, cinnabar or copper,  
 " *having previously occupied and improved the same*  
 " *according to the local customs or rules of miners*  
 " in the district where the same is situated \* \* \*  
 " it shall be lawful for said claimant \* \* \* to  
 " file in the local land office a diagram of the  
 " same, conformed to the local laws, customs and  
 " rules of miners and to enter such tract and re-  
 " ceive a patent therefor."

This recognition by Congress of the local rules of miners in the several districts, make them a part and parcel of the statutes, and occupying the mine in accordance with their provisions, is an antecedent condition to the sale of any mineral land, and until so occupied the land department has no jurisdiction, power or authority to dispose of the same.

In Section 4 of the same Act, Congress provides that *surface* ground may be disposed of in accordance with the local rules. Again express-

ing its intent to have them control their grants. All mineral land not so held is as clearly reserved from sale under the provisions of Section 2318, construed in connection with the other statutes, as is possible for language to express.

As stated above, it is found that the surface ground in dispute was never possessed or located as an incident to the quartz lode patented, and also that there was no local rule by which it could have been. It follows then that the patent is void, void for want of authority in the land officers to make the grant, having never acquired jurisdiction of the subject matter of the grant.

But plaintiff contends that the patent conclusively proves the existence of local customs and rules of miners in that district compatible with the dimensions of the tract described. We fully concede the conclusiveness of a patent as to all matter of mere form in the procedure leading up to the issuance of it, and the necessity for such a rule. But matters which the law makes jurisdictional, facts which must exist under the law before such land can be sold, do not come within the rule. The patent is but the final step in a series of steps taken by the department. It is the final judgment of that "Court" that it has the power to convey, and does convey to the patentee, the given tract. The law, in all cases, declares what

lands may be sold, and the antecedent conditions upon which the department may convey them, and the conveyance when executed, carries with it the presumption that the officers have done their duty, but such presumption is never conclusive as to the *power and authority* to act.

The Supreme Court of the United States, in case of *New Orleans vs. United States*, 10 Peters, 731, say, in discussing the validity of certain grants from the King of Spain to certain lots in the water front of that city: "It would be a dangerous doctrine to consider the *issuing of a grant* as conclusive evidence of right in the "power which issued."

Wepples Proceedings in Rem., Sec. 568.

McMann vs. Whelan, 27 Cal., 313.

Hyde vs. Kedding, 74 Cal., 493.

In the case of *Doolan vs. Carr*, 125 U. S., 620, cited above, this question is elaborately discussed, and the authorities upon which our contention rests, cited and approved. The patent in that case was regular upon its face, and carried with it the presumption that in issuing it the officers of the Land Department had performed their duty. It showed upon its face to have been founded upon a valid grant. It was admitted by the character of the defense to have been public land of



the United States at the time of the grant and issuance of patent, and also of a class and character of land contemplated by the grant. Defendant relied upon the *fact*, that at the time of the grant the land described in the patent was within the exterior boundaries of a large tract, out of which a small Spanish grant was to be carved, and for that reason reserved from sale, and therefore the department had no power to issue the patent. Not only was this defense sustained, but the case holds that the identity and location of the land within the exterior limits of the larger tract could be shown by oral testimony.

Under these authorities, it is difficult to conceive a case in which a defendant may not show the fact, where the officers issuing a patent have acted without authority of express law, and in view of them all, it cannot be said that a mining patent is conclusive evidence of the existence of mining rules and their contents. True, these laws so justly eulogized by Justice Field and sanctioned and upheld by all the Courts, do not, like statutes, come within the judicial knowledge of the Courts, but when shown to exist as a fact, they become a portion of the existing law referred to in *Smelting Co. vs. Kemp*, 104 U. S., 636, and must control the Court in passing upon the va-

lidity of a grant as absolutely as the most solemn enactment of a legislative body.

In placer mineral patents the department regulations require the land officers to ascertain before issuing them whether any quartz lodes are known to exist within the boundaries of the placer claim. It may and often is determined *as a fact* by the Land Department that no such lode exists, but such investigation and determination will in no wise control or limit the right of any one authorized to mine to go upon the patented placer claim, and work a quartz lode known to exist therein at the time of issuing patent. If, in such case, the quartz miner is sought to be ejected, all he has to do is to show by oral testimony that the lode was known to exist at the date of patent, and ejection fails.

Reynolds vs. Iron Silver M. Co., 116 U. S.  
687.

In Iron and Silver Mining Co. vs. Campbell, 135 U. S. 286, the question arose as to the conclusiveness of a patent for a quartz lode upon land which had been previously patented as a placer mine. The holder of the Junior Quartz patent contended that the patent was conclusive of the fact that the lode was known to exist at the time the placer patent was issued. The Court below

held with this contention, but the Supreme Court reverses the decision, holding that the *two facts*, the existence of the vein, and the knowledge of its existence to the party applying for the placer patent, are always and ultimately a question of judicial cognizance.

### Want Of Notice.

We say the department had no authority to issue this patent because it gave no notice of the application or intention to apply for it.

The law provided, "That upon the filing of the  
 " diagram \* \* \* the Register of the land  
 " office shall publish a notice of the same in a  
 " newspaper published nearest the location of said  
 " claim \* \* \* for the period of ninety days  
 " \* \* \* and after the expiration of said period  
 " it shall be the duty of the Surveyor General to  
 " survey, etc."

The notice to be given is of the filing in his office and posting of notice and diagram required of the applicant. It is the summons which this officer must issue and serve before he can possibly acquire the right or power to determine the applicant's claim to a patent. We do not find where this point has been discussed by the Courts; but the Secretary of the Interior, in the

Antelope Patent Case, Sickles Mining Laws, 174, says, "Congress, in my opinion, never intended " that a patent should issue for any mineral lands " where an application for patent had not first " been advertised and notice given \* \* \* a " construction that would result in such conse- " quences is inadmissible." It would result in de- " stroying every safeguard which Congress in- " tended to throw around the sale of the mines."

In the same opinion at Id. 162, he holds that the application and published notice are jurisdictional, and that a patent cannot issue lawfully in excess of them. This would seem to be elementary, if the proceedings of the department under this statute have any analogy to other tribunals to determine rights.

In this connection we call the Court's attention to the application and notice (p. 9).

The Register gave no notice. McGee & Thompson, over their own names, caused the notice which we have above referred to, to be posted and published and did so before going to the land office.

The Attorney General of the United States, in an opinion found at page 177-8, Sickles Mining Laws, says the law makes it the legal duty of the Register to prepare and give notice.

For this additional reason the Land Department never acquired jurisdiction of the subject matter of the grant.

Plaintiff has specified a great many errors of law committed by the trial Court, and several particulars in which he claims the findings unsupported by the evidence, but in his brief he virtually concedes that if the main propositions for which he contends are not maintainable, the errors complained of have not affected his material rights. The findings are all supported by the evidence and if our contentions are sound law the Court has made no errors.

We submit that the judgment of the Court below is just and in accordance with law, and should be affirmed.

GOODWIN & GOODWIN,  
Attorneys for Defendants in Error.



No. 28.

---

IN THE

# United States Circuit Court of Appeals.

NINTH CIRCUIT.

---

WM. H. LAKIN, Plaintiff in Error,

VS.

J. H. ROBERTS et al., Defendants in Error.

---

## PETITION FOR REHEARING.

---

H. L. GEAR,

*Attorney for Petitioner.*

---

GEO. SPAULDING & CO., PRS., 414 CLAY ST., SAN FRANCISCO.

FILED  
MAR - 4 1893





UNITED STATES CIRCUIT COURT OF APPEALS  
FOR THE NINTH CIRCUIT.

---

WM. H. LAKIN,

*Plaintiff in Error,*

*vs.*

J. H. ROBERTS ET AL.,

*Defendants in Error.*

---

PETITION FOR REHEARING.

The plaintiff in error respectfully petitions the said Circuit Court of Appeals to grant a rehearing of the above entitled cause, and in support of his petition respectfully urges upon the attention of the Court the following considerations:

**Question of Statutory Construction.**

The case, as decided by the Court, is made to hinge upon the construction of the revised statutes of the United States, upon the single question whether the *width* of lode claims located prior to the passage of the Act of May 10th, 1872, is absolutely limited by the terms of section 2320, declaring that "no claim shall extend more than three hundred feet on each side of the vein at the surface;" so that, notwithstanding a location of surface of greater width for working purposes on the working side of a vein, made prior to the Act of May 10th, 1872, was covered and protected by the terms of the original Mining Act of July 26th, 1866, and notwithstanding an application for a patent for such claim

was pending in the Land Office, upon a preliminary survey and diagram of the claim in accordance with sections 1, 2, 3 and 4 of the Act of 1866, and notwithstanding the time for adverse claim under the application had expired prior to the passage of the Act of 1872, yet no entry could be made or patent issued under such pending application after the passage of said Act, for any greater quantity of surface on either side of the lode line than three hundred feet.

It appears from the record in this case that the application for the patent the validity of which is in controversy, was for a quartz lode extending along a mountain side; that the surface lines of the location extended fifty feet up the mountain above the line of the lode, but were so extended laterally down the side of the mountain as to include the surface between the lode and Jamison creek about one thousand feet distant, for working purposes, in order to include all tunnels run or to be run into the side of the mountain, a tramway and road leading from the tunnel to the creek, a millsite located along the creek and certain timber and the water of the creek for working purposes—all of which were needed for the convenient working of the ledge. It was represented to the Land Office, in the application for the patent for the claim, that the applicants had previously occupied the land applied for and improved the same according to the local customs and rules of miners in the district where the same was situated, and had expended in actual labor and improvement thereon an amount not less than one thousand dollars, and that there was no controversy as to the claim to their knowledge, and that

they therewith presented a diagram of said mining claim so extended as to conform to the rules of said mining district. (Record, folio 53.) The records of the Land Office establish that the requisite notice required by the Sec. 3, of the Act of 1866, was thereupon given for the period of ninety days, and that no adverse claim was filed in the Land Office at any time. (Record, folio 53-4.) They also show that a preliminary survey of the claim had been made by the Deputy Surveyor-General, in conformity to which the diagram had been filed and posted on the claim and in the Land Office. (Record, folio 51.) They also show that after the passing of the Act of May 10th, 1872, to wit, in 1877, the Surveyor-General approved and filed the preliminary survey of the claim made by his deputy (Record, folio 51, 54); that an entry was made by the successors of the applicants in pursuance of the original application (Record, folio 56-7), and a patent was thereupon issued to them. The patent purports to be issued pursuant to the revised statutes of the United States, but the descriptive references therein contained taken in connection with the entry and survey fully identify the claim granted with the claim applied for by the original applicants, and entered by their successors in interest. The receiver's receipt showing the entry for the patent expressly identifies the land entered and paid for with the land applied for by the original applicants under the Act of July 26th, 1866. (Record, folio 56-57.)

The question, therefore, is whether the second section of the Act of 1872, incorporated in Sec. 2320 of the revised statutes by the provision therein contained that "no claim

shall extend more than three hundred feet on each side of the middle of the vein at the surface," operated retroactively so as *ipso facto* to destroy the validity of the Mammoth Claim as to any excess of three hundred feet in width between the lode and Jamison creek, and utterly to deprive the Land Department of jurisdiction to receive an entry or issue a patent therefor, although the claim had been previously covered and protected to its full extent by the express terms of the Act of 1866.

There are three sets of considerations, either one of which seems to me conclusive against the construction adopted by the Court; the cumulative effect of which, in my judgment, demonstrates that the Court has mistaken the true construction and operation of the statute.

*The words cited from the statute are prospective only, and relate to claims located after May 10, 1872, and not to any claim previously located, MUCH LESS TO ANY CLAIM FOR WHICH A RIGHT TO MAKE AN ENTRY FOR A PATENT HAD PREVIOUSLY CRYSTALLIZED UNDER A PENDING APPLICATION, MADE PRIOR TO MAY 10, 1872.*

### I. Act of 1872 Prospective by its Terms.

Sec. 2320 of the revised statutes, considered by itself, without reference to other statutory provisions or inquiry as to the principles by which its construction is to be determined, is ambiguous in its phraseology. The words: "*No claim shall extend more than three hundred feet in width on each side of the middle of the vein at the surface,*" may possibly be construed *all comprehensively and retroactively* so as to operate upon previously located claims, as well as upon those located after the passage of

the Act of May 10, 1872. On the other hand, they may be construed prospectively as applying only to claims located after the passage of that Act.

If they be construed retrospectively, we must supply by implication from the whole of the previous context, after the words "no claim" the words "heretofore or hereafter located." If, on the other hand, we construe the words prospectively only, we have only to supply by implication from the immediately preceding context the words "located after the tenth day of May, 1872."

Construing the last three sentences of Sec. 2320 together, as they may be construed without violence, they regulate the *length, discovery, width, and parallelism of end lines of all claims located after the passage of the Act of May 10, 1872*, and neither of them has any retroactive operation upon claims theretofore located.

The provision in regard to the parallelism of end lines of "*each claim*" in the last sentence of the section, is just as broad and comprehensive in its phraseology as that in regard to the width of claims. But the Supreme Court has expressly recognized the prospective operation of that provision. It has said:

"Under the Act of 1866, parallelism in the end lines of a surface location was not required; but, *when a location has been made since the Act of 1872*, such parallelism is essential to the existence of any right in the locator or patentee to follow his vein outside of the vertical planes drawn through the side lines."

*Iron Silver Mining Co. vs. Elgin M. and S. Co.*,  
118 U. S., 196-209.

It may well be asked, if the last sentence of section 2320 of the revised statutes is prospective in its operation, why should not the next to the last sentence be likewise prospective only.

It is undeniable that if the last two sentences of Sec. 2320 had been connected directly with the second sentence of the section, by means of semicolons and the use of the conjunction "and," instead of being separated therefrom by periods, there could be no room to doubt the intention of Congress to give each of them only a prospective operation. The last three sentences of the section would then read together as follows:

"A mining claim located after the tenth day of May, 1872, whether located by one or more persons, may equal but shall not exceed one thousand five hundred feet in length along the vein or lode; but no location of a mining claim shall be made until the discovery of the vein or lode within the limit of the claim located; and no claim shall extend more than three hundred feet in width on each side of the middle of the vein at the surface, nor shall any claim be limited by any mining regulation to less than twenty-five feet on each side of the middle of the vein at the surface, except where adverse rights existing on the tenth day of May, 1872, render such limitation necessary; and the end lines of each claim shall be parallel to each other."

Punctuation may be disregarded in the construction of a statute, or the Court may repunctuate if need be, to render the true meaning of the statute.

*Hammock vs. Farmers Loan and Trust Co.*, 105  
U. S., 77.

*United States vs. Lacher*, 134 U. S., 624.

*Martin vs. Gleeson*, 139 Mass., 183.

*Cushing vs. Worrick*, 9 Gray., 382.

The phraseology of statutes may be changed by the interpolation or elimination of words, in order to reach the intent of the enactment, or to prevent some inconvenience, absurdity, hardship or injustice presumably not intended.

Endlich on Int. of Statutes, Sec. 295 *et seq.*

But, as already suggested, there is no necessity for actually changing the punctuation, or phraseology, or collocation of sentences in Sec. 2320, in order to prevent the hardship and injustice attending a retroactive construction. The last previous subject-matter of enactment preceding the last two sentences of Sec. 2320, relates expressly to claims "*located after the tenth day of May, 1872.*" If now we apply the comprehensive terms used in the succeeding sentences to all claims of the same character as those last before mentioned, and supply in brackets the matter of appropriate reference implied, the last two sentences would be understood as follows:

"No claim [located after the 10th day of May, 1872] shall extend more than three hundred feet on each side of the middle of the vein at the surface," etc. "The end lines of each claim [located after the 10th day of May, 1872] shall be parallel to each other."

The objection that under this interpretation the statute would appear *defective*, in merely providing for the *length* of claims located prior to May 10th, 1872, and not providing for their *width*, is fully met and answered by a

proper consideration of section 2322 of the revised statutes. This section corresponds with section 3 of the Act of 1872, which immediately follows the section of that Act embodied in section 2320, without the interpolation of the section embodied in section 2321, which is taken from section 7 of the Act of 1872. Section 2322, corresponding to section 3 of the Act of 1872, provides as follows:

“That *the locators of all mining locations heretofore made, or which shall hereafter be made, on any mineral vein or ledge situated on the public domain, their heirs and assigns, where no adverse claim exists on the 10th day of May, 1872, so long as they comply with the laws of the United States, and with State, Territorial and local regulations not in conflict with the laws of the United States governing their possessory title, shall have the exclusive right of possession and enjoyment OF ALL THE SURFACE INCLUDED WITHIN THE LINES OF THEIR LOCATIONS,*” etc.

The fact that this section also applies as well to the rights of locators of all mining locations “which shall hereafter be made,” and that the right of possession and enjoyment is qualified generally by the terms “*so long as they comply* with the laws of the United States,” etc., affords no reply to the proposition that the locators of previous locations are expressly protected to the full extent of “ALL THE SURFACE INCLUDED WITHIN THE LINES OF THEIR LOCATIONS.”

The condition that all locators shall “*comply* with the laws of the United States,” can only refer to such acts of compliance as are affirmatively required by those laws.



The conditions of annual labor, and of the mode and terms of future applications for patents, or the presentation of adverse claims during the period limited therefor, must be complied with by all to whom those conditions apply. So likewise, all persons who undertake to locate claims after the passage of the Act of 1872, must comply with the requirements of that statute as to the manner and extent of the location. But the condition of *complying* with the Act of 1872, so far as regards the *location* of claims, manifestly does not and cannot apply to mining locations made before the passage of that Act. If a prior location had been made which was protected by the Act of 1866, the Act of 1872 nowhere requires the locator to *re-locate* it, or if it had been surveyed and diagrammed upon application for a patent under the former Act, nowhere requires him to *resurvey* his claim, or to *make, or file in the Land Office, any new diagram* thereof. He has therefore *nothing to comply with* on his part, *as respects the lines of his location*. But so long as he *complies* with the laws of the United States, and other laws *governing his possessory title* in so far as they require *acts of compliance* on his part, he is expressly protected, as are “the locators of all mining locations heretofore made,” in the “EXCLUSIVE RIGHT OF POSSESSION AND ENJOYMENT OF ALL THE SURFACE INCLUDED WITHIN THE LINES OF THEIR LOCATIONS.”

No good reason appears why the *length* of lode claims located prior to May 10, 1872, should be determined by the laws in force at the date of the location, to the exclusion of the *width* of surface lawfully occupied by the locators for working purposes. The *lode* is certainly *the*

*principal thing of value*: and if an association of persons can claim 3,000 feet along a lode, instead of merely 1,500 feet, because the location was made prior to the Act of 1872, there seems to be no good reason why they should not be allowed the *incidental privilege* of “a reasonable quantity of surface for the convenient working of the same, as fixed by local rules,” although the surface may on the only working side of the lode exceed three hundred feet in width. The bare and unproductive surface down a mountain side is presumably of far less value than the lode, and it seems unreasonable to construe the statute as *making more of the incident* than it does of *the principal thing*.

But no room is left for doubt as to the wholly prospective nature of the provision of the Act of 1872 limiting claims to three hundred feet in width on each side of the vein, when the express terms of that Act are considered. THE ACT OF 1872 CONTAINS THE MOST FORMAL AND EXPRESS RESERVATION OF ALL EXISTING RIGHTS ACQUIRED UNDER THE ACT OF 1866.

Sec. 9 of the Act of 1872, reads as follows:

“SEC. 9. That sections one, two, three, four and six of ‘An Act granting the right of way to ditch and canal owners over the public lands, and for other purposes,’ approved July twenty-sixth, eighteen hundred and sixty-six, are hereby repealed, BUT SUCH REPEAL SHALL NOT AFFECT EXISTING RIGHTS. APPLICATIONS FOR PATENTS NOW PENDING MAY BE PROSECUTED TO A FINAL DECISION IN THE GENERAL LAND OFFICE; but in such cases, where adverse rights are not affected there-

by, patents may issue in pursuance of the provisions of this Act; and all patents for mining claims heretofore issued under the Act of July twenty-sixth, eighteen hundred and sixty-six, shall convey all the rights and privileges conferred by this Act, where no adverse rights exist at the time of the passage of this Act."

The foregoing section expressly declares the intent of Congress to preserve unabridged and unaffected all of the "EXISTING RIGHTS" held by mining claimants under the Act of 1866. Instead of designing to abridge them in the least, they are expressly enlarged as are the rights of all prior patentees who received their patents under the law of 1866, by the grant of all lodes which may be discovered to have their apices within the boundaries of their claims. This is manifestly all that is intended by declaring that patents under pending applications "may issue in pursuance of the provisions of this Act," the only exception being where at the time of its passage there was an adverse claim to some other ledge extending within the lines of the surface applied for. A patent issued under the Act of 1866 alone, without this grant, would merely carry the lode applied for, with the right to use the surface granted for working purposes only, subject to the rights of any other locator to locate any other subsequently discovered ledge which might be found to cross the patented surface. By the grant of the additional privilege of any other ledges which may be discovered within the surface applied for by means of a patent issued under the Act of 1872, no limitation of any existing right as to the extent of surface properly enjoyed for working purposes under the provisions of the Act of

1866, can be at all inferred, in face of the express reservation of "*existing rights*" from the effect of the repeal of that Act. Nor is there any more ground to assume such limitation, because of the additional grant of privileges under the Act of 1872, to an applicant for a patent under the Act of 1866 than there is to assume a limitation upon prior patentees under that Act whose rights are expressly enlarged by grant in the same connection, without in any manner limiting the existing rights previously granted.

It is further to be observed that in Sec. 12, of the Act of 1872, are found the following additional words expressly preservative of rights previously acquired under the Act of 1866.

"Nothing in this Act shall be construed to enlarge or effect the rights of either party in regard to any property in controversy at the time of the passage of this Act or of the Act entitled 'An Act granting the right of way to ditch and canal owners over the public lands, and for other purposes,' approved July twenty-sixth, eighteen hundred and sixty-six, **NOR SHALL THIS ACT AFFECT ANY RIGHT ACQUIRED UNDER SAID ACT.**"

But, *as if to clinch, by a third nail*, BEYOND THE POSSIBILITY OF CONTROVERSY, THE PROPOSITION THAT THE ACT OF 1872, WAS INTENDED BY ITS TERMS TO BE PROSPECTIVE ONLY, AND NOT TO IMPAIR ANY EXISTING RIGHT WHATEVER, we find in Sec. 16, of that Act, the following **UNEQUIVOCAL LANGUAGE:**

"SEC. 16. That all Acts and parts of Acts inconsistent herewith are hereby repealed; **PROVIDED, THAT**

NOTHING CONTAINED IN THIS ACT SHALL BE CONSTRUED TO IMPAIR, IN ANY WAY, RIGHTS ACQUIRED UNDER EXISTING LAWS."

The effect of this proviso, taken in connection with the express reservation of "*existing rights*" under the Act of 1866, made in section 9, and of "*any rights acquired under said Act,*" in section 12, was undoubtedly to continue in existence by the very terms of the Act of 1872, every right acquired previous to its passage and existing at its date which was covered and protected by the Act of 1866, and *absolutely to forbid any retrospective construction or operation of the Act of 1872, so as to impair those rights* "IN ANY WAY."

The proviso contained in Sec. 16, of the Act of 1872, is embodied in the same terms in section 2344 of the revised statutes.

All of the rights preserved by the Act of 1872, are further expressly preserved and protected by section 5597, of the revised statutes, which is declarative of the uniform policy of Congress to preserve all rights, and not to impair them by any retrospective operation or construction whatever.

That section reads as follows:

"SEC. 5597. The REPEAL of the several Acts embraced in said revision SHALL NOT AFFECT ANY ACT DONE, OR ANY RIGHT ACCRUING OR ACCRUED, OR ANY SUIT OR PROCEEDING HAD or commenced in any civil cause BEFORE THE SAID REPEAL, BUT ALL RIGHTS and liabilities under said Acts SHALL CONTINUE, AND MAY BE ENFORCED IN THE SAME MANNER,

AS IF SAID REPEAL HAD NOT BEEN MADE," etc.

The Court is thus not only warranted, but expressly required to look to the terms of the repealed Act of 1872, to find out what rights existed under it, or were continued in existence by it; for all existing rights were regarded by Congress as *sacred*, and as enforceable under the terms of laws existing at the date of the revision in like manner, as if there had been no repeal of those laws. It is further to be considered that by the use of the words "*former laws*," in section 2328 of the revised statute, which declares that "*applications for mining claims UNDER FORMER LAWS now pending may be prosecuted to a final decision in the General Land Office*," etc., Congress expressly intended to refer to applications pending *under the original quartz mining law of 1866, and under the original placer mining law of 1870*, applications under both of which laws were expressly protected from all invasion or retrospective impairment "IN ANY WAY," by the express terms of the Act of 1872.

The Supreme Court has repeatedly recognized the justice and propriety of consulting the terms of the statutes embodied in the revision as an aid to their construction, and even in cases of their undoubted prospective operation, where there is any ambiguity in the revision.

*U. S. vs. Lacher*, 134 U. S., 624.

*U. S. vs. Bowen*, 100 U. S., 508, 513.

*U. S. vs. Hirsch*, 100 U. S., 33.

*Myer vs. Western Car Co.*, 102 U. S., 111.

*U. S. vs. Le Bris*, 121 U. S., 278.

*A fortiori*, must the original statutes be consulted in

order to ascertain what rights held under them were *intended to be preserved from any retrospective impairment* by the revision, *according to its express terms* to that effect.

## II. Retrospective Construction Inadmissible.

To sustain a retrospective construction of the statute in question, to the impairment of a right previously covered and protected by the law, it must appear, not only that such construction is not forbidden by the terms of the statute itself, but also that the right is not in the nature of a grant, or vested right of property, and that the intent to divest, impair or destroy it in any particular, is so clearly and unambiguously expressed beyond a reasonable doubt, that any merely prospective interpretation of the statute would be wholly inadmissible and unreasonable, and contrary to its express and unequivocal terms.

### A. *Nature of Mining Claims—Rights of Property Vested by Grant.*

It has been repeatedly held that a mere personal and unassignable privilege of pre-emption of public land is not such a vested right that Congress has not the power, if it chooses unequivocally to exercise it, to withdraw the privilege before payment is made under it, and to dispose of the land in some other manner. But a careful consideration of the decisions of the Supreme Court of the United States as to the nature of mining claims, and the effect thereupon of the mining Acts of Congress, will disclose that the rights of mining claimants under these laws, are ~~far~~<sup>far</sup> more than a mere pre-emption privilege, and that prior to payment or patent they are in the nature of *rights of property vested by conditional*

*grant from Congress bestowing a right of exclusive possession and enjoyment, which cannot be divested against the consent of the grantee, so long as the conditions are complied with, without impairing the obligation of a contract between the government and the owner of the claim.*

It is well settled that rights vested under a statutory grant can not be divested at the mere will of the law making power.

*Fletcher vs. Peck*, 6 Cranch., 87.

*Ferrett vs. Taylor*, 9 Cranch., 43.

*Town of Pawlett vs. Clark*, 9 Cranch., 292.

*Grogan vs. San Francisco*, 18 Cal., 591.

*Benson vs. Mayor*, 10 Barb., 223.

An accepted conditional grant made by law is a binding contract, the obligation of which cannot be impaired by the government, while the conditions are complied with by the grantee.

*McGechee vs. Mathis*, 4 Wall., 143.

*Davis vs. Gray*, 16 Wall., 203.

In the light of these principles we call attention to the following citations of authority from which we quote, to show that mining rights protected by the mining law of Congress, are in the nature of *vested rights of property*.

“The Government, by its silent acquiescence, assented to the general occupation of the public lands for mining.  
\* \* \* He who first connects his own labor with property thus situated, and open to general exploration, does, in natural justice acquire a better right to its use and enjoyment than others who have not given such labor. So



the miners on the public lands throughout the Pacific States and Territories, by their custom, usage and regulations, everywhere recognized the inherent justice of this principle; and the principle itself was at an early period recognized and enforced by the Courts of those States and Territories. \* \* \* ‘So fully recognized have become these rights, that, without any specific legislation conferring or confirming them, they are alluded to and spoken of in various Acts of the Legislature in the same manner as if they were *rights which had been vested* by the most distinct expression of the will of the law makers.’ This doctrine of *right by prior appropriation* was recognized by the legislation of Congress in 1866. The Act granting the right of way to ditch and canal owners over the public lands, and for other purposes, passed on the 26th of July of that year, in its 9th section, declares, ‘that, whenever by priority of possession right to the use of water for mining, agricultural, manufacturing or other purposes, have *vested and accrued*, and the same are recognized and acknowledged by the local customs, laws and decisions of courts, the possessors and owners of such VESTED RIGHTS shall be maintained and protected in the same.’ ”

*Atchinson vs. Peterson*, 20 Wall., 507.

“Such rights as the mining laws allow and as Congress concedes, to develop and work the mines, is *property in the miner*, and property of great value. \* \* \* Those claims are the *subject of bargain and sale*. \* \* \* They are PROPERTY IN THE FULLEST SENSE OF THE WORD, and *their ownership, transfer and use* are governed by a well de-

fined code or codes of law, and *are recognized by the States and Federal Government.*”

*Forbes vs. Gracey*, 94 U. S., 762, 767.

“It is the established doctrine of this Court that rights of miners who had taken possession of mines and worked and developed them, and the rights of persons who had constructed canals and ditches, etc., \* \* \* are RIGHTS WHICH THE GOVERNMENT HAD BY ITS CONDUCT RECOGNIZED AND ENCOURAGED, AND WAS BOUND TO PROTECT, BEFORE THE PASSAGE OF THE ACT OF 1866.”

*Broder vs. Natoma M. and M. Co.*, 101 U. S., 274.

“A mining claim perfected under the law is *property in the highest sense of that term, which may be bought, sold and conveyed and will pass by descent.* There is nothing in the Act of Congress which makes actual possession any more necessary for the protection of the *title acquired to such a claim by a valid location*, than it is for any other *grant from the United States.* The language of the Act is that the locators ‘*shall have the exclusive right of possession and enjoyment of all the surface included within the lines of their locations,*’ which is to continue until there shall be a failure to do the required amount of work within the prescribed time. \* \* \* A location, to be effectual, must be good at the time it is made. When perfected, *it has the effect of a grant by the United States of the rights of present and exclusive possession.*”

*Belk vs. Meagher*, 104 U. S., 279.

“Every interest in lands is the subject of sale and

transfer, unless prohibited by statute, and no words allowing it are necessary. *In the mining statutes numerous provisions assume and recognize the salable character of one's interest in a mining claim.* \* \* \* He can hold as many locations as he can purchase, and rely upon his possessory title. He is *protected thereunder as completely as if he held a patent* for them, subject to the condition of certain annual expenditures upon them in labor or improvements. If he wishes, however, to obtain a patent, he must, in addition to other things, pay the government a fee of \$5 an acre, a sum that would not be increased if a separate patent were issued for each location."

*St. Louis Smelting Co. vs. Kemp*, 104 U. S., 636.

"Though by appropriate proceedings and the payment of a very small sum, a legal title in the form of a patent may be obtained for such mines, the *possession under a claim established according to law is fully recognized by the Acts of Congress, and the patent adds little to the security of the party in continuous possession of a mine he has discovered or bought.*"

*Chambers vs. Harrington*, 111 U. S., 350.

Mining locations, "when perfected under the law, ARE THE PROPERTY OF THE LOCATOR, OR THEIR ASSIGNS, AND ARE NOT, THEREFORE, SUBJECT TO THE DISPOSAL OF THE GOVERNMENT." It appearing that the locators had "done all that was necessary under the law" to complete a valid location, "*they had then done all that was necessary under the law for the ACQUISITION OF AN EXCLUSIVE RIGHT TO THE POSSESSION AND ENJOYMENT OF THE GROUND.* The claim was thenceforth THEIR PROPERTY. They

needed only a patent of the United States to render their title perfect, and that they could obtain at any time upon proof of what they had done in locating the claim, and of subsequent expenditures to a specified amount in developing it. UNTIL THE PATENT ISSUED, THE GOVERNMENT HELD THE TITLE IN TRUST FOR THE LOCATORS OR THEIR VENDEES. THE GROUND ITSELF WAS NOT AFTERWARDS OPEN TO SALE.”

*Noyes vs. Mantle*, 127 U. S., 348.

Where an application for a patent has been made and the time for adverse claim is past, no third person can be heard, but *the applicant is* “THE EQUITABLE OWNER OF THE MINING GROUND, AND THE GOVERNMENT HOLDS THE PREMISES IN TRUST FOR HIM, TO BE DELIVERED UPON THE PAYMENTS SPECIFIED.”

*Dahl vs. Raunheim*, 132 U. S., 260.

*Dahl vs. Montana Copper Co.*, 132 U. S., 264.

“*The location itself has the effect of a GRANT*, or as Justice Knowles said in *Robertson vs. Smith*, 1 Mont., 416, ‘it is a TITLE GIVEN BY AN ACT OF CONGRESS, and hence EQUIVALENT TO A PATENT FROM THE UNITED STATES.’ THE PATENT IS SIMPLY THE EVIDENCE OF THIS PRECEDENT GRANT; and must necessarily relate back to it.”

*Talbott vs. King*, 9 Pac. Rep., 441; 6 Mont., 76.

“A valid location of a quartz lode mining claim is a GRANT FROM THE GOVERNMENT TO THE LOCATOR *thereof*, and carries with it the right, by a compliance with the law, of obtaining a full and complete title to all the lands included within the boundaries of the claim, which by the

location are withdrawn from sale and pre-emption, and *the patent when issued relates back to the location, and is not a distinct grant, but the consummation of the grant, which had its inception in the location of the claim.*"

*Butte City Smoke House Lode Cases*, 12 Pac. Rep.,  
859; 6 Mont., 397.

If the foregoing decisions are a correct enunciation of the law, it follows that each of the mining Acts of Congress created rights which were *vested by the grant of Congress*, and such VESTED RIGHTS could not be divested by the operation of any retrospective enactment,

B. *Retrospective Construction not Allowable, Prospective Construction Being Possible.*

But, further, regardless of the question whether an Act of Congress *could be effectual, to divest an existing right* to a mining claim which it had previously granted, and regardless of the fact that Congress *has expressly declared its intention to preserve all rights* which it had previously granted or protected, it is sufficient to forbid any retrospective construction of section 2320 of the revised statutes so as to divest an existing right of surface possessed for working purposes under the Act of 1866, that a prospective construction which will not impair or interfere with such right is possible, and is not expressly forbidden by the words of the statute.

In order that a prospective construction should be expressly forbidden by the language of the statute, we must insert after the words "*no claim,*" the words "*whether heretofore or hereafter located.*" But there are no such words in the statute; and there is nothing expressly to

forbid a prospective construction. On the contrary, the impairment *in any way* of any right existing under the Act of 1866, is expressly forbidden by the terms of the Act of 1872. Yet, if such impairment were not expressly forbidden by the terms of the statute, it would be equally forbidden by the uniform rule that a possible prospective construction not contrary to the express language of the statute forbids a retrospective construction of the statute. This rule is by no means limited in its operation to cases where vested rights are of such a nature that they could not be impaired by retroactive legislation; but is equally effective to forbid the *impairment of any right previously covered by law, by a retrospective construction* of a new law, which does not in express terms purport to impair or take away such right, although there may be constitutional power to take it away.

Endlich, in his admirable work on the Interpretation of Statutes, lays down the rules applicable to this question of retrospective construction in the most explicit terms, enforcing them by very numerous citations of authority. He says (*italics are ours*):

“ § 271. **General Presumption Against Retroactive Operation.**— *Upon the presumption that the Legislature does not intend what is unjust rests the leaning against giving certain statutes a retrospective operation. Nova Constitutio futuris formam imponere debet, non praeteritis.* They are construed as operating only on cases or facts which come into existence after the statutes were passed, unless a retrospective effect be clearly intended. Indeed, *the rule to be derived from the comparison of a vast number of judicial utterances upon this subject, seems to be, that,*

*even in the absence of constitutional obstacles to retroaction, a construction giving to a statute a prospective operation is always to be preferred, unless a purpose to give it a retrospective force is EXPRESSED BY CLEAR AND POSITIVE COMMAND, OR TO BE INFERRED BY NECESSARY, UNEQUIVOCAL AND UNAVOIDABLE IMPLICATION, FROM THE WORDS OF THE STATUTE, taken by themselves and in connection with the subject matter and the occasion of the enactment, ADMITTING OF NO REASONABLE DOUBT, BUT PRECLUDING ALL QUESTION AS TO SUCH INTENTION."*

"§ 272. **Prospective Effect Apparently Contrary to Words.**—*Even where there is that in the statute which would seem upon other principles of interpretation, to require a retroactive construction, THE PRESUMPTION AGAINST THE SAME, in the absence of intention otherwise demonstrable to give the statute such an effect, WILL OVERCOME THE INFLUENCE OF SUCH RULES."*

"§ 273. **Acts Affecting Vested Rights.**—It is chiefly where the enactment would prejudicially affect vested rights, or *the legal character of past transactions*, that the rule in question prevails. Every statute, it has been said, which takes away or impairs vested rights, or creates a new obligation, or imposes a new duty, or *attaches a new disability in respect of transactions or considerations already past*, MUST BE PRESUMED, OUT OF RESPECT TO THE LEGISLATURE, TO BE INTENDED NOT TO HAVE A RETROSPECTIVE OPERATION. On the contrary, it was said in a recent case in England, *prima facie the general rule of construing acts of Parliament is, that they are prospective, and RIGHTS ARE NOT TO BE INTERFERED WITH, UNLESS THERE ARE EXPRESS WORDS TO THAT EFFECT. And this*

*requisite of* EXPRESS DECLARATION, POSITIVE EXPRESSION, AND THE LIKE, HAS BEEN REPEATEDLY INSISTED UPON IN DECISIONS IN THIS COUNTRY.”

The Supreme Court of the United States has declared itself unequivocally in reference to these rules of construction:

“ WORDS IN A STATUTE OUGHT NOT TO HAVE A RETROSPECTIVE OPERATION, UNLESS THEY ARE SO CLEAR, STRONG AND IMPERATIVE THAT NO OTHER MEANING CAN BE ANNEXED TO THEM, OR UNLESS THE INTENTION OF THE LEGISLATURE CANNOT BE OTHERWISE SATISFIED. THIS RULE OUGHT ESPECIALLY TO BE ADHERED TO, WHEN SUCH A CONSTRUCTION WILL ALTER THE PRE-EXISTING SITUATION OF THE PARTIES, OR INTERFERE WITH THEIR ANTECEDENT RIGHTS.”

Per Paterson, J., in *U. S. vs. Heth*, 3 Cranch., 413.

“ *A statute is never to be so construed as to have this (viz., a retrospective) effect, if it can be reasonably avoided. THE PRESUMPTION UNTIL REBUTTED, IS THE OTHER WAY.*”

*U. S. vs. Moore*, 95 U. S., 760.

“ IF IT BE CONCEDED THAT CONGRESS COULD DO THIS, THE PRINCIPLE IS TOO WELL ESTABLISHED TO NEED THE CITATION OF AUTHORITIES, THAT NO LAW WILL BE CONSTRUED TO ACT RETROSPECTIVELY, UNLESS ITS LANGUAGE IMPERATIVELY REQUIRES SUCH A CONSTRUCTION.”

*Auffmordt vs. Raisin*, 112 U. S., 620.

“ COURTS UNIFORMLY REFUSE TO GIVE TO STATUTES A RETROSPECTIVE OPERATION;



WHEREBY RIGHTS PREVIOUSLY VESTED ARE INJURIOUSLY AFFECTED, UNLESS COMPELLED TO DO SO BY LANGUAGE SO CLEAR AND POSITIVE AS TO LEAVE NO ROOM TO DOUBT THAT SUCH WAS THE INTENTION OF THE LEGISLATURE.”

*Cheong Hong vs. U. S.*, 112 U. S., 536.

“EVEN THOUGH THE WORDS OF A STATUTE ARE BROAD ENOUGH IN THEIR LITERAL EXTENT TO COMPREHEND EXISTING CASES, THEY MUST YET BE CONSTRUED AS APPLICABLE ONLY TO CASES THAT MAY HEREAFTER ARISE, UNLESS THE LANGUAGE EMPLOYED EXPRESSES A CONTRARY INTENTION IN UNEQUIVOCAL TERMS.”

*Twenty per cent. Cases*, 20 Wall., 179.

“As a general rule for the interpretation of statutes, it may be laid down, that they NEVER SHOULD BE ALLOWED A RETROACTIVE OPERATION WHERE THIS IS NOT REQUIRED BY EXPRESS COMMAND OR BY NECESSARY AND UNAVOIDABLE IMPLICATION. WITHOUT SUCH COMMAND OR IMPLICATION THEY SPEAK AND OPERATE UPON THE FUTURE ONLY.”

*Murray vs. Gibson*, 15 How., 421.

“IT IS OF THE VERY ESSENCE OF A NEW LAW THAT IT SHALL APPLY TO FUTURE CASES, AND SUCH MUST BE ITS CONSTRUCTION, UNLESS THE CONTRARY CLEARLY APPEARS.”

*McEwen vs. Den*, 24 How., 242.

The rules thus laid down by Endlich, and approved by the Supreme Court of the United States, are everywhere recognized.

In *Dash vs. Van Kleeck*, 7 Johns, 503, Chief Justice Kent says:

“ A statute is not to be construed so as to work the destruction of a right previously attached. We are to presume *out of respect to the law-giver*, that the statute was not meant to operate retrospectively, and if we call to our attention the general sense of mankind, on the subject of retrospective laws, it will afford us the best reason to conclude that the legislature did not intend in this case to set so pernicious a precedent. \* \* \* *It is a principle in the English common law, as ancient as the law itself, that A STATUTE, EVEN OF ITS OWN OMNIPOTENT PARLIAMENT, IS NOT TO HAVE A RETROSPECTIVE EFFECT.*”

In *Sackett vs. Andros*, 5 Hill, 334, there is an able review of principles and authorities upon this important question. Brunson, J., says:

“ *It is a general rule that a statute should not be construed so as to give it a retrospect beyond the time of its commencement* (2 Mis., 492; 1 Black, Conn., 45-6; Pac. Atk., Statute 6.) *This is not only the doctrine of the common law, but it is a GENERAL PRINCIPLE OF GENERAL JURISPRUDENCE* (Dunn on Stat., 680; *Dash vs. Van Kleeck*, 7 Johns, 477, per Kent, C. J.) *AND GENERAL WORDS IN A STATUTE SHALL BE RESTRICTED SO AS NOT TO DO A WRONG TO ANY ONE.* \* \* \* The case of *Gibson vs. Shute*, is reported in several books. (1 Freer, 466; 7 Jones, 108; 2 Ler., 227; 1 Show., 17; 2 Wood, 310; 1 Vent., 330.) There was first a parol promise made in

consideration of marriage. Then came the statute of 29 Car. 2, Ch. 3, declaring 'that no action shall be brought whereby to charge any person upon ANY agreement in consideration of marriage,' unless the same shall be in *writing*. *Nothing could be more comprehensive than this language.* It included promises which had already been made, just as plainly as it did those which should be made in future, and yet in this action which was commenced after the passage of the Act, the plaintiff was allowed to recover upon the parol promise. Although the express words of the Act were strongly pressed upon the consideration of the Court by Serjeant Maynard, they held that past promises were not within the statute, 'for it would be very unreasonable to put such a construction upon the Act as should make it have a retrospect to invalidate and nullify contracts and agreements that were lawful at the time when they were made.' A case was mentioned by the Court which is directly to the present purpose. Another branch of the statute of frauds had provided that 'all devises and bequests of any lands' shall be in writing and be attested by three or four credible witnesses, or else they shall be utterly void and of no effect.' And yet the Court said, it had been resolved that a will made before the statute was formed, though not so attested was good, although the testator did not die until after the statute was enacted, and that was truly said to be a stronger case than the one in hand, '*because the party might have altered his will, if he had pleased; but an agreement he cannot, without the consent of the other party.*' In *Ashburnham vs. Bradshaw* (2 Atk., 36) there was a devise to charitable uses; then came a *new statute* of

mortmain, declaring *all* such dispositions of property to be void, and afterwards the testator died. The case was referred for the opinion of the judges, who certified that the devise was good notwithstanding the statutes and Lord Hardwicke thereupon established the will, and directed the trusts to be carried into execution. A like decision was made upon the same statute in *Attorney-General vs. Andrews* (1 Ves. Sen., 225) and see *Wilkinson vs. Meyer* (2 Ld. Raym., 1350.) In *Couch vs. Jeffries* (4 Burr., 2460) the same rule of construction was applied to another statute. ALTHOUGH THE PLAINTIFF'S CASE WAS CLEARLY WITHIN THE WORDS OF THE ACT, HIS RIGHT WAS SAVED BY DENYING THE RETROSPECTIVE OPERATION OF THE LAW. Lord Mansfield said: 'Here is a *right vested*, and it is not to be imagined that the Legislature could *by general words* mean to take it away. They certainly meant *future* actions.' The same doctrine was fully maintained by this Court in *Dash vs. Van Kleeck* (7 John., 477.) The question was whether a statute subsequently passed should take away a right of action previously vested in the plaintiff; and the Court held it should not, *although the case was plainly within the words of the law*. Thompson, J., said, 'it is repugnant to the first principles of justice, and the equal and permanent security of rights to take by law the property of one individual, without his consent, and give it to another. The principle contended for on the part of the defendant inevitably <sup>leads</sup> to and sanctions such a doctrine.' He added, 'IT CAN NEVER BE PRESUMED FROM THE GENERAL WORDS OF THIS STATUTE THAT THE LEGISLATURE INTENDED IT SHOULD WORK SUCH INJUSTICE.'

NOTHING SHORT OF THE MOST DIRECT AND UNEQUIVOCAL EXPRESSIONS WOULD JUSTIFY SUCH A CONCLUSION.' He said further that the Act established a *new rule*, 'AND AS SUCH OUGHT NOT TO HAVE A RETROSPECTIVE OPERATION, UNLESS SO DECLARED IN THE MOST UNEQUIVOCAL MANNER, *which it certainly is not.*' These views were fully sustained in the opinion delivered by Chief Justice Kent, who proved that *the same doctrine prevails in the civil law.* INDEED, IT IS SO CONSONANT WITH THE PRINCIPLES OF NATURAL JUSTICE, THAT IT MUST BE FOUND EVERYWHERE, UNTIL WE GET BEYOND THE LIMITS OF CIVILIZATION."

### III. Construction of Land Department to be Followed as a Rule of Property.

For more than twenty years the Land Department of the United States has construed the words in question here as prospective only, and a rule of property has grown up under its construction, which ought not at this late day to be disturbed.

On the 10th day of June, 1872, the Commissioner of the General Land Office issued its circular for the information of all the District Land Offices, and of mining claimants generally, embodying the text of the Act of May 10, 1872, and declaring:

"*Second.* By an examination of the several sections of the foregoing Act, it will be seen that *the status of lode claims located previous to the date thereof is not changed with regard to their extent along the lode* OR WIDTH OF SURFACE, such claims being restricted and governed both as to their *lateral* and *lineal* extent by the State, territo-

rial or local customs or regulations, which were in force at the date of such location, in so far as the same does not conflict with the limitations fixed by the mining statute of July 26, 1866.

“ *Eighth.* Applications for patents for mining claims pending at the date of the Act of May 10, 1872, may be prosecuted to final decision in the General Land Office, and when no adverse rights are affected thereby, patents will be issued in pursuance of the provisions of said Acts.

“ *Tenth.* With regard to the extent of surface ground adjoining a vein or lode, and claimed for the convenient working thereof, the Act provides that the lateral extent of location of veins or lodes *made after its passage*, shall in no case exceed three hundred feet on each side of the middle of the vein at the surface,” etc.

Copp’s U. S. Mining Dec. (ed. 1874), pp. 270, 275, 277.

These instructions were clearly warranted by the express reservations made in the Act of 1872, for the absolute protection of all existing rights.

Every circular of instruction issued from the General Land Office since that date, whether under the Act of 1872, or under the revised statutes, has followed the same construction, and hundreds of patents have been issued since May 10, 1872, and since the adoption of the revised statutes, in pursuance of that construction. The patent in controversy is a practical proof of the construction placed upon the revised statutes by the Land Department.

The Chollar-Potosi Mine in Nevada, patented under

the Act of 1866, appears to have had a width of 1,081 feet, and a length of 1,400 feet.

Copp's U. S. Mining Laws (ed. of 1874), pp. 96-7.

Many other patents have been issued both before and since the Act of 1872, in pursuance of the Act of 1866, conveying an irregular surface of many acres, occupied in connection with a lode for working purposes throughout the Pacific States and Territories.

On Dec. 26, 1872, the Commissioner of the General Land Office wrote as follows in a decision addressed to the Register of the local land office at Central City, Colorado:

“On the 10th of May, 1872, Congress passed a new mining Act, and repealed said section two of the Act of 1866, expressly declaring, however, in the ninth section thereof, that “such repeal shall not affect existing rights,” and again in the twelfth, “nor shall this Act affect any rights acquired under said Act” of July 26, 1866, and to impress this point more fully, the same idea is again repeated in the sixteenth section, where it declares that “nothing in this Act shall be construed to impair in any way rights or interests in mining property acquired under existing laws.” *Where the application for patent was pending under the Act of July 26, 1866, on the 10th day of May, 1872,* NONE OF THE RIGHTS WHICH THE APPLICANT HAD ACQUIRED BY VIRTUE OF COMPLIANCE WITH SAID ACT OF 1866, WERE AFFECTED OR IMPAIRED IN ANY WAY. \* \* \* AND ALL PATENTS ISSUED SINCE THE 10TH DAY OF MAY, 1872, UPON APPLICATIONS PENDING AT THAT TIME, EXPRESSLY CONVEY TO THE PATENTEE:

“*First. THE SURFACE GROUND EMBRACED BY THE INTERIOR BOUNDARIES OF THE SURVEY,*” etc.

Copp’s U. S. Mining Dec. (Ed. 1874), pp. 154–5.

In a communication to the Surveyor-General of Wyoming, Nov. 18, 1873, the Commissioner of the General Land Office wrote as follows:

“If the claim was located prior to May 10, 1872, the *size of the claim, both as regards the length and width*, is regulated by the local laws, customs and rules. If the claim was discovered since May 10, 1872, the size of the claim is limited by the Act bearing date the 10th May, 1872.

“Very respectfully, etc.,

“WILLIS DRUMMOND, Commissioner.”

*Id.*, p. 235.

On June 29, 1875, the Secretary of the Interior decided that “a *bona fide* application for a patent under the Act of 1866 is such *an appropriation of the premises embraced therein* as to take them out of the operation of the local laws” upon the question of an abandonment or forfeiture of the claim, and that consequently, under an application made Oct. 16, 1866, a patent might issue under an entry made in 1874, if there had been continuous possession of the claim, and no failure to comply with the provisions of the mining Act.

Sickles Mining Dec., p. 67.

Other decisions of the Land Department are as follows:

“*An application for a patent withdraws the lands therein described from subsequent application, until the first*



*application is withdrawn or rejected.*" (June 11, 1880.)

Sickles Mining Dec., p. 105.

"After an application has been made for a patent for a given mining claim, such claim is *virtually withdrawn from market*, pending the final disposition of the case." (Nov. 5, 1874.)

*Id.* p. 116.

"Where the application for patent was pending under Act of 1866, on the 10th day of May, 1872, *none of the rights which the applicant had acquired by virtue of compliance with said Act of 1866, were affected or impaired in any way*, but patents issued upon applications of this class convey the same rights which were conveyed under the Act of 1866, together with all other veins or lodes, the tops or apexes of which lie inside the exterior boundaries of the surface ground patented to the extent and in the manner provided by the third section of the Act of May 10, 1872." (Aug. 17, 1874.) *Id.*, p. 188.

These rulings of the Land Department, and many others not reported, in respect to the issuance of patents applied for under the Act of 1866, ought now to be followed as a RULE OF PROPERTY. If the original construction of the law were doubtful, their unchallenged construction of it, as prospective only, for a period of twenty years, ought not now to be challenged or overthrown.

"In the construction of a doubtful or ambiguous law, the contemporaneous construction of those who were called upon to act under it, *and were appointed to carry its provisions into effect, is entitled to very great weight.*"

*Edwards' Lessee vs. Darby*, 12 Wheat., 210.

*Hahn vs. U. S.*, 107 U. S., 402-406.

*U. S. vs. Johnson*, 124 U. S., 236.

“The construction given to a statute by those charged with the duty of executing it is always entitled to the most respectful consideration, and ought not to be overruled without cogent reason. The officers concerned are usually able men and masters of the subject. Not unfrequently they are the draftsmen of the laws they are afterwards called upon to interpret.”

*U. S. vs. Moore*, 95 U. S., 760.

*Brown vs. U. S.*, 113 U. S., 568.

*Heath vs. Wallace*, 138 U. S., 573.

“It is a familiar rule of interpretation, that, in the case of a doubtful and ambiguous law, the contemporaneous construction of those who have been called upon to carry it into effect is entitled to great respect. While, therefore, the question is by no means one free from doubt, we are not inclined to interfere at this late day with a rule which has been acted upon by the Court of Claims, and the executive for so long a time.”

*U. S. vs. Pugh*, 99 U. S., 265.

See also—

*U. S. vs. Philbrick*, 120 U. S., 52.

*U. S. vs. Hill*, 120 U. S., 169.

“This contemporaneous and uniform interpretation is entitled to weight in the construction of the law, and in a case of doubt, ought to turn the scale.”

*Brown vs. U. S.*, 113 U. S., 568.

“This construction of the statute in practice, concurred in by all the departments of the government and continued for so many years, *must be regarded as absolutely conclusive in its effect.*”

*U. S. vs. Hill*, 120 U. S., 169.

“The principle that *the contemporaneous construction of a statute by the executive officers of the government, whose duty it is to execute it, is entitled to great respect, and SHOULD ORDINARILY CONTROL THE CONSTRUCTION OF THE STATUTE BY THE COURTS*, is so firmly imbedded in our jurisprudence that no authorities need be cited to support it. ON THE FAITH OF A CONSTRUCTION THUS ADOPTED, RIGHTS OF PROPERTY GROW UP, WHICH OUGHT NOT TO BE RUTHLESSLY SWEEP ASIDE, unless some great public measure, benefit or right is involved, or unless the construction itself is manifestly incorrect.”

*Pennoyer vs. McConnaughey*, 140 U. S., 1.

“It is a settled doctrine of this Court that, *in case of ambiguity, the judicial department will lean in favor of a construction given to a statute by the department charged with the execution of such statute, and, IF SUCH CONSTRUCTION BE ACTED UPON FOR A NUMBER OF YEARS, WILL LOOK WITH DISFAVOR UPON ANY SUDDEN CHANGE, WHEREBY PARTIES WHO HAVE CONTRACTED WITH THE GOVERNMENT UPON THE FAITH OF SUCH CONSTRUCTION MAY BE PREJUDICED. IT IS ESPECIALLY OBJECTIONABLE THAT A CONSTRUCTION OF A STATUTE FAVORABLE TO THE INDIVIDUAL CITIZEN SHOULD BE CHANGED IN SUCH MANNER AS TO BECOME RETROACTIVE.*”

*U. S. vs. Alabama Great Southern R. R. Co.*, 142  
U. S., 615.

### Conclusion.

The plaintiff in error cannot believe that this Court has fully weighed all of the foregoing considerations and authorities, and that it intends deliberately to hold that the express declarations of Congress as to the reservation and protection of all rights acquired under or covered by the mining Act of 1866, are to be disregarded, in the construction of the Act of 1872, and of the revised statutes; that the decisions of the Supreme Court of the United States and other authorities cited, as to the nature of mining property, and against the retrospective construction of statutes, and in favor of a contemporaneous and long continued prospective construction by the officers charged with the execution of the laws, are all to be disregarded in favor of a retrospective construction of the section in controversy

It would seem that, unless the Court can at this late day judicially see that the prospective construction of the Act of 1872, and of the revised statutes, declared by their very terms to be the intention of Congress, and which has been uniformly followed by the Land Department for the past twenty years, is so inherently foolish and unreasonable, that it could not justify the establishment of any rule of property under it, and is not worthy to be dignified with the name of a construction of the statute, the Court ought, by every consideration, to adopt and follow it, and not to overthrow and set it aside. For these

reasons, plaintiff in error respectfully asks for a rehearing of this cause.

H. L. GEAR,  
Attorney for Plaintiff in Error.

---

I hereby certify that the foregoing petition for rehearing is presented in good faith, and not for delay, and in my opinion it is well founded in point of law.

H. L. GEAR,  
Attorney for Plaintiff in Error.



No. 30

UNITED STATES  
CIRCUIT COURT OF APPEALS  
FOR THE  
NINTH CIRCUIT.

OCTOBER TERM, 1891.

THE UNITED STATES of AMERICA,

*Appellee.*

vs.

THE STEAM TUG "PILOT," Her  
Steamers, Engines, Boilers, Ma-  
chinery, Tackle, Apparel, Furni-  
ture, Etc.,

*Respondent.*

JOAN OLIVE DUNSMUIR,

*Appellant,*

~ ~ RECORD. ~ ~

P. H. WINSTON, U. S. District Attorney,  
*Attorney for Appellee.*

BURKE, SHEPARD & WOODS,  
*Attorneys for Appellant.*

*Lowman & Hanford Stationery & Printing Co., Seattle.*

FILED

FEB 15 1892





UNITED STATES  
CIRCUIT COURT OF APPEALS

FOR THE  
NINTH CIRCUIT.

---

OCTOBER TERM, 1891.

---

THE UNITED STATES OF AMERICA.

*Appellee.*

vs.

THE STEAM TUG "PILOT," Her  
Steamers, Engines, Boilers, Machinery,  
Tackle, Apparel, Furniture, Etc.,

*Respondent.*

JOAN OLIVE DUNSMUIR,

*Appellant.*

---

: : RECORD. : :

IN THE DISTRICT COURT OF THE UNITED STATES FOR THE  
DISTRICT OF WASHINGTON, NORTHERN DIVISION.

<p>THE UNITED STATES OF AMERICA,</p> <p style="text-align: center;"><i>Libellant.</i></p> <p style="text-align: center;">vs.</p> <p>THE STEAM TUG PIOT, Her Steam- ers, Engines, Boilers, Machinery, Tackle, Appparel, Furniture, Etc.,</p>	}
---	---

*To Honorable C. H. Hanford, Judge of the District Court of the  
United States, in and for the District of Washington, North-  
ern Division.*

Comes now the United States Attorney for the District of Washington, and for and in behalf of the United States of America and all persons concerned and files this libel of information against the said steam tug Pilot, her steamers, engines, boilers, machinery, tackle, apparel, furniture, etc., etc., and informs the Court as follows :

That on the 5th day of May, 1891, within the Customs District of Puget Sound, and upon the waters of Puget Sound, and within the Northern Division of said District of Washington, the Honorable C. M. Bradshaw, the duly qualified and acting Collector of Customs for the District of Puget Sound did sieze and now hath in his possession as being forfeited to the United States for violation of Section 4370 of the Revised Statutes of the United States, that certain tug Pilot, her engines, boilers, steamers, machinery, tackle, apparel and furniture, etc., etc.

That the said steam tug boat was not at said date and at

no time a tug boat of the United States, but was a tug boat owned by foreigners at Victoria, British Columbia.

That on the 3rd day of May, 1891, the said steam tug boat Pilot, being then and there a British steam tug boat from Victoria, British Columbia, towed an American bark, Valley Forge, of 1286 tons burden, on her way from San Francisco, California, to Port Angeles, Washington, the said bark Valley Forge being then and there a documented vessel of the United States plying from one port of place in the same to another.

That upon the seizure of the said tug Pilot by said Collector of Customs as aforesaid a fine or penalty of fifty dollars per ton of the tonnage of the bark Valley Forge, amounting to six hundred and forty-three dollars, was assessed against the said steam tug Pilot, her steamers, engines, boilers, machinery, tackle, apparel, furniture, etc., etc. which penalty has not been paid to libellant, and for these reasons the said tug Pilot was seized by the Collector of Customs as aforesaid, and is still in his possession at Port Angeles, State of Washington.

That all and singular the premises are true and within the Admiralty and Maritime jurisdiction of the United States, and of this Honorable Court; and for which the United States Attorney prays process of this Honorable Court in the premises and for a monition that the steam tug Pilot may be decreed to be forfeited to the United States of America.

P. H. WINSTON,  
*United States Attorney.*

By P. C. SULLIVAN.  
*Asst. U. S. Atty.*

Interrogatories to be answered by any claimant of the tug boat Pilot; mentioned in the annexed libel.

1. Who are the owners of the tug boat Pilot, and who were the owners on May 5, 1891, and for thirty days prior thereto?

2. Who was the master of said tug boat?

3. At what foreign port or place is said tug boat registered and at what foreign port or place does she belong?

4. At what place did the said tug boat Pilot first commence towing the said bark Valley Forge?

And on the back of the foregoing is endorsed the words and figures following :

IN THE DISTRICT COURT OF THE UNITED STATES FOR THE  
DISTRICT OF WASHINGTON, NORTHERN DIVISION.

UNITED STATES,

vs.

THE STEAM TUG PILOT, Her  
Steamers, Engines, Boilers,  
Etc.

} 259. Libel.

Filed May 12, 1891, in the U. S. District Court.

R. M. HOPKINS,  
*Clerk.*

DISTRICT OF WASHINGTON, ss.

*The President of the United States of America to the Marshal of the United States for the Northern Division, District of Washington, greeting :*

[SEAL]

Whereas, a libel of Information hath been filed in the District Court of the United States for the Northern Division, District of Washington, on the 12th day of May, in the year of our Lord one thousand eight hundred and ninety-one by the United States Attorney for the District of Washington, against

The steam tug "Pilot" her boilers, machinery, tackle, apparel, furniture etc., for the reasons and causes in the said libel of information mentioned, and praying the usual process and monition of the said Court in that behalf to be made, and that all persons interested in the said steam tug Pilot, etc., may be cited in general and special to answer the premises and all proceedings be had that the said steam tug Pilot etc, may for the causes in the said libel of information mentioned, be condemned and sold to pay the demands of the United States of America.

You are therefore hereby commanded to attach the said steam tug "Pilot" etc, and to detain the same in your custody until the further order of the Court respecting the same, and to give due notice to all persons claiming the same, or knowing or having anything to say why the same should not be condemned and sold pursuant to the prayer of the said libel of information, that they be and appear before the said Court, to be held in and for the Northern Division, District of Washington, on the 6th day of August,

1891, at eleven o'clock in the forenoon of the same day, if the same day shall be a day of jurisdiction, otherwise on the next day of jurisdiction thereafter, then and there to interpose a claim for the same and to make their allegations on that behalf. And what you have done in the premises do you then and there make return thereof, together with this writ.

Witness the Hon. C. H. Hanford, Judge of said Court, at the City of Seattle, in the Northern Division, District of Washington, this 21st day of July in the year of our Lord one thousand eight hundred and ninety-one and of our independence the one hundred and sixteenth.

R. M. HOPKINS,  
*Clerk.*

P. H. WINSTON,  
*U. S. Attorney.*

And on the back of the foregoing is endorsed the words and figures following :

In obedience to the within monition, I attached the steam tug Pilot therein described on the 22nd day of July, 1891, and have given due notice to all persons claiming the same that this Court will on the 6th day of August, 1891, (if that day should be a day of jurisdiction, if not, on the next day of jurisdiction thereafter), proceed to the trial and condemnation thereof, should no claim be interposed for the same. Fees \$14.90.

THOS. R. BROWN,  
*U. S. Marshal.*

By W. A. PRINCE,  
*Deputy Marshal.*

Dated July 24th, 1891.

DISTRICT COURT OF THE UNITED STATES, DISTRICT OF WASHINGTON.

UNITED STATES  
 vs.  
 THE STEAM TUG PILOT, ETC. }

Monition returnable Aug. 6, 1891.

P. H. WINSTON,  
*U. S. Attorney.*

Issued July 21, 1891.

Filed July 25, 1891,

R. M. HOPKINS,  
*Clerk.*

IN THE DISTRICT COURT OF THE UNITED STATES FOR THE DISTRICT OF WASHINGTON, NORTHERN DIVISION.

UNITED STATES OF AMERICA, }  
   *Libelant,* } In Admiralty.  
 vs. }  
 THE SEATM TUG "PILOT" her }  
   steam engines, boilers, ma- }  
   chinery, tackle, apparel, fur- }  
   niture, etc., }  
   *Respondent.* }

Plea, civil and maritime upon fine or penalty for violation of Section 4370 of the United States revised statutes.

And now Joan Olive Dunsmuir intervening for her interest, appears before the above entitled Court and makes claim to the said steam tug "Pilot," her steam engines, boilers, tackle, apparel and furniture as the same are attached by

the Marshal under process of this Court at the instance of the United States of America, libelant; and the said Joan Olive Dunsmuir avers that she was in possession of the said steam tug Pilot, both at the time of the seizure of said steam tug by the Collector of Customs at Port Angeles and at the time of the attachment thereof by the Marshal, and that Joan Olive Dunsmuir, above named, is the true and *bona fide* owner of the said steam tug "Pilot," and that no other person or persons is or are the owners thereof, and that ——— Lawrence is the master of the said steam tug Pilot.

Wherefore she prays to be admitted to defend accordingly.

JOAN OLIVE DUNSMUIR,

By THOMAS BURKE,

*Proctor in Admiralty.*

Sworn and subscribed to on this

14th day of May, 1891, be-

fore me,

[SEAL]

JOSEPH M. GLASGOW,

*Notary Public in and for the State*

*of Washington, residing at Seattle.*

And on the back of the foregoing is endorsed the words and figures following:

DISTRICT COURT OF THE UNITED STATES, DISTRICT OF WASHINGTON, NORTHERN DIVISION.

UNITED STATES OF AMERICA, }

vs. }

STEAM TUG "PILOT." }

No. 259. Claimant's Plea.

Filed this 14th day of May, 1891.

R. M. HOPKINS,

*Clerk.*



IN THE DISTRICT COURT OF THE UNITED STATES FOR THE  
 DISTRICT OF WASHINGTON, NORTHERN DIVISION.  
 IN ADMIRALTY.

THE UNITED STATES OF AMERICA,	}	Amended Answer.
<i>Libelant,</i>		
vs.		
STEAM TUG PILOT, Her Steam En- gines, Boilers, Machinery, Etc.,		
<i>Respondent</i>		
And JOAN OLIVE DUNSMUIR,	}	
<i>Claimant.</i>		

*To the Honorable Cornelius H. Hanford, Judge of the District Court of the United States, in and for the District of Washington, Northern Division.*

The amended answer of Joan Olive Dunsmuir, claimant and owner of the steam tug "Pilot," her steam engines, boilers, etc., to the libel of the United States of America for alleged violation of Section 4370 of the Revised Statutes of the United States, showeth :

1. That the allegations of the libel that the certain steam tug "Pilot," violated Section 4370 of the Revised Statutes of the United States in towing a certain alleged American bark named "Valley Forge" into the port of Port Angeles on the 3rd day of May, 1891, is not true, the facts being as follows :

That on or about six P. M. on the 2nd day of May, 1891, the said tug boat "Pilot," spoke the said alleged American

Bark Valley Forge about three miles off Port San Juan on the Island of Vancouver, in the Province of British Columbia, the said Valley Forge being bound to Departure Bay upon the coast of the Island of Vancouver, in British Columbia, and the captain of said Valley Forge wishing to be towed to departure Bay in said British Columbia by way of Port Angeles, and from Departure Bay back through the straits of San Juan de Fuca ; that the captain of the said tug boat Pilot agreed upon the 2nd day of May, 1891, with the captain of the said Bark Valley Forge to tow the said Valley Forge from the said point about three miles off Port San Juan, off the coast of said Vancouver Island in said British Columbia, to Departure Bay by way of Port Angeles, and from Departure Bay back through the Straits of San Juan de Fuca to the Pacific Ocean. That under and in accordance with said agreement to tow the said bark Valley Forge from said point of meeting three miles off the said Port San Juan, the captain of the said tug boat Pilot did on the 2nd day of May, 1891, and on the subsequent day tow the said bark Valley Forge into the port of Port Angeles. That the said towing from the said point three miles off the said Port San Juan to the said port of Port Angeles was in part within and upon foreign waters, the said Port San Juan being as aforesaid situated upon the south shore of Vancouver Island in the Province of British Columbia. That after having towed the said bark Valley Forge to Port Angeles as aforesaid the captain of the said Valley Forge was unable to continue immediately to Departure Bay, and that the tug boat Pilot thereupon cleared from the port of Port Angeles on or about the 3rd day of May, 1891, and that subsequently on or about the 5th day of May, the said tug boat Pilot returned to said Port Angeles for the purpose of completing the towing in accordance with the contract made with the captain of the bark Valley Forge. That

upon the return of said tug boat Pilot to the said port of Port Angeles on or about the 5th day of May, said tug boat Pilot was seized by the collector of the port at Port Angeles which seizure is the seizure alleged in the libel of the libelant, and which acts as aforesaid are the acts referred to and complained of in the said libel as being in violation of Section 4370 of the Revised Statutes of the United States.

2. And for answer to the interrogatories propounded by the libelant herein, the claimant says, in answer to the first of said interrogatories that the owner of the said tug boat Pilot and the owner on May, 5, 1891, and for thirty days prior thereto was Joan Olive Dunsmuir of Victoria, British Columbia, Dominion of Canada; in answer to the second interrogatory claimant says the master of said tug boat Pilot was and now is Thomas Lawrence of Victoria, British Columbia, in answer to the third interrogatory, said tug boat Pilot is registered at Victoria, British Columbia, and belongs to the port of Victoria, British Columbia; for answer to the fourth interrogatory, the claimant herein says that the said tug boat Pilot first commenced towing the said bark Valley Forge at a place about three miles distant from Port San Juan upon Vancouver Island in the Province of British Columbia, Dominion of Canada.

3. That all and singular the premises are true.

Wherefore the claimant herein prays that the Court will be pleased to pronounce against the libel aforesaid and otherwise right and justice to administer in the premises.

BURKE, SHEPARD & WOODS,  
*Proctors in Admiralty for the Claimant.*

STATE OF WASHINGTON }  
COUNTY OF KING. } ss.

Andrew Woods, being duly sworn, says that he is one of the proctors for the claimant herein; that he has read the,

foregoing amended answer and knows the contents thereof and believes the same to be true ; that he makes this affidavit because the claimant and owner, Joan Olive Dunsmuir, of the said steam-tug pilot is not within the District of Washington but is a foreigner now residing at Victoria, British Columbia.

ANDREW WOODS.

Subscribed and sworn to before me, this 25th day of September, 1891.

R. M. HOPKINS,  
*Clerk.*

And on the back of the foregoing is endorsed the words and figures following :

U. S. DISTRICT COURT.

UNITED STATES	}	No. 259.
vs.		
STEAM TUG PILOT.		

BURKE, SHEPARD & WOODS,  
*Proctors for Claimants.*

Filed this 25th day of Sept., 1891.

R. M. HOPKINS,  
*Clerk.*

## UNITED STATES OF AMERICA.

IN THE DISTRICT COURT OF THE UNITED STATES FOR THE  
DISTRICT OF WASHINGTON, NORTHERN DIVISION.

THE UNITED STATES	}
<i>Libelant,</i>	
vs.	
THE STEAM TUG PILOT, Her Steam- ers, Engines, Boilers, Etc.,	}
<i>Claimant.</i>	

Trial before Hon. C. H. Hanford, September 25, 1891.

United States District Attorney Patrick H. Winston, for the libelant and Messrs. Burke, Shepard & Woods, for claimant.

Statement of the case by the United States District Attorney, Patrick H. Winston.

Mr. Bradshaw, a witness produced on the part of the libelant having been first duly sworn, testified as follows.

Question. Mr. Winston: Mr. Bradshaw, you are the duly qualified and acting Collector of Customs for the District of Puget Sound, are you not?

Answer. I am.

Q. State whether you seized the tug Pilot or caused her to be seized.

A. I caused her to be seized at Port Angeles on the 5th day of May.

Q. On the 5th of May?

A. Yes sir; last.

Q. 1891?

A. Yes sir.

Q. What was she engaged in doing at that time that caused this seizure?

A. She was accused of towing a vessel, the American vessel Valley Forge, on her way from San Francisco to Puget Sound, and of towing her into Port Angeles from the sea.

Q. Was that American vessel a documented vessel?

A. She is.

Q. What kind of a documented vessel is she.

A. She is

Q. I mean by that to ask you if—Was she required to clear when she sails from the port of San Francisco?

A. I think she was under enrollment and license at the time.

Q. She is under enrollment and license in your district?

A. No sir.

Q. Your impression is that she is under enrollment and license in the collection district of San Francisco?

A. Yes sir. She has been documented in this district but she changed her home port and owners to San Francisco. Of course her owners residing there she is compelled to do so.

Q. She was a documented vessel and under enrollment at that time?

A. Yes sir at that time.

Q. At what time do you speak of?

A. In May last.

Q. Now a vessel documented under enrollment and license is not required to clear?

A. No sir, not if passing from one district to another; if she goes foreign she has to change her papers and turn in and register.

Q. Had she done so?

A. I think she was under an enrollment and license at the time.

Q. She was towed into Port Angeles by this steam tug.

A. It was so reported to me by an official report.

Q. What was the burden of the American bark Valley Forge?

A. I think something over 1200 tons.

Mr. Winston: I believe that is not denied, Mr. Wood?

Mr. Wood: No sir; we do not deny that.

Q. Mr. Winston: The tug Pilot is owned by foreigners at Victoria, as I understand it?

A. She is a British vessel.!

Q. Do you know where the Valley Forge, where she cleared from this time,—where she came from?

A. I do not know, except what I have been told, that she was from San Francisco.

Q. You don't know when she left San Francisco?

A. No sir, she runs clear of custom houses, being under enrollment and license.

Mr. Winston: That is all.

#### CROSS EXAMINATION.

Q. Mr. Wood: How do you know, Mr. Bradshaw, that this Valley Forge was a documented American vessel?

A. I know she was documented in the Port Townsend Custom House.

Q. At what time was that?

A. I do not now remember. She changed her papers not long ago.

Q. How long ago?

A. I couldn't state that, but it is not more than a year ago.

Q. Was it a year ago?

A. Well, I could not say just how long ago.

Q. Do you know of your own knowledge whether or not, at the time of this towing, she was an American documented vessel?

A. I did not see her documents.

Q. Do you know whether she cleared from San Francisco or not, of your own knowledge?

A. I don't know as anybody knows that.

Q. Do you know her destination?

A. I know she did come to Puget Sound.

Q. Where did she go from here?

A. She went to Port Madison, I think.

Q. You do not know where the boat went after she left Port Angeles?

A. She came up the Sound.

Q. You are sure of that?

A. I am sure of that, yes sir; I am quite sure of that although I do not think I saw her, but that is my recollection of the circumstances.

Q. Is not all of this testimony that you have given here, Mr. Bradshaw, mere heresay?

A. It is what I have gathered from official reports. I have not stated that I saw the vessel at all.

Q. And you do not know the point at which she was first met by this tug "Pilot?"

A. No I do not.

Q. You know nothing about the towing—whether the towing actually occurred?

A. No sir.

Q. All of your information has been derived from reports? Made to you by others?

A. Yes; reports of an official character, and some of it from the attorneys of the "Pilot."

Q. You do not even know where the Valley Forge came from, of your own knowledge?

A. She came from San Francisco; I did not see her leave there.



Q. When was the date, according to your reports, of the seizure of the tug Pilot.

A. Well, I don't remember the date of the seizure. I think the date of the report of the towing in was on the 5th of May; that is my recollection.

Q. You think that the date of towing was on the 5th of May?

A. On the 3rd of May; I am not sure about the date; I may have gotten that confused with the date of the fining of the vessel.

Q. Do you know whether or not the seizure of the tug Pilot was made immediately upon her arrival?

A. No I think not; I think she came in subsequently, but I would not be certain. I could have refreshed my recollection by the records had I known that I was going to testify.

Q. You know nothing about the papers that the "Valley Forge" had?

A. No sir.

Q. Whether she cleared for an American or foreign port?

A. No sir:

Mr. Winston: We will excuse Mr. Bradshaw with the understanding that he may be recalled?

The Libelant rests.

Thomas Lawrence, a witness called on the part of the claimant having been first duly sworn testified as follows

Q. (Mr. Wood): Captain Lawrence, were you captain of the tug Pilot during the month of May, 1891?

A. Yes sir.

Q. Did you, on the 2nd day of May, 1891, speak the American bark Valley Forge in the waters off the coast of Vancouver Island?

A. In the Straits of Fuca, about three miles off the Port

San Juan, about ten miles inside the entrance of the Straits located on the south shore of Vancouver Island.

Q. What is the width of the Straits at that point ?

A. About twelve miles.

Q. Have you a chart of that part of the Straits ?

A. Yes sir.

Q. Is the width given there ?

A. No sir.

Q. Do you know Captain Lawrence, how much of these waters, in distance from Vancouver Island, is British waters ?

A. Half of the Straits, as I have always understood.

Q. What distance then would be within British waters ?

A. Six miles.

Q. All within six miles from San Juan would be British waters ?

A. Yes sir: my bearing of the point was four miles.

Q. At what time was it that you saw the Valley Forge ?

A. When I was first coming down the Straits, about 3 o'clock.

Q. What time did you speak them ?

A. Oh, between 4 and 5 o'clock.

Q. What took place then ?

A. I hailed the captain of the ship and asked where he was bound.

Q. What did he say ?

A. He told me he was bound to Departure Bay ; that is in British Columbia.

Q. Go on and state to the Court all that took place between you and the captain.

A. We talked there for probably half an hour or so making a bargain about the tow.

Q. What was the conversation ?

A. That would be about the tow. At last we came to a bargain about towing him to Departure Bay ; then he asked

me if I could call at Port Angeles with him ; I says, “ Yes ; as long as you are in our waters, I can.” He says, “ you are all right, you are way over on the Vancouver shore by a long way.”

Q. Was there any contract about towing from Departure Bay out ?

A. I asked him to take notice of where he was—his position.

Q. After arriving at Departure Bay what else were you to do ?

A. Tow him from where he was then to Departure Bay, calling at Port Angeles, and when he was loaded to tow him to sea.

Q. Did you at that time take the exact point of your location when you picked up the Valley Forge ?

A. Yes, we always do.

Q. At what point was that ?

A. The east point of San Juan, bearing southwest four miles.

Q. Have you any evidence of the correctness of that ?

A. I don't know about the bearing, but I have evidence of the distance.

Q. Did you make any record at the time that you took her in tow ?

A. Yes, by the log-book.

Q. Have you got that log-book here ?

A. Yes sir, it is here somewheres.

(Book produced.)

Q. Is that the log book ?

A. Yes sir.

Q. Have you any record in that book of the time when you first began to tow the Valley Forge ?

A. Yes sir ; we always make a record.

Q. (Referring to log-book) In the first place, what was the date?

A. Second of May, Saturday.

Q. Read the record please.

A. Saturday, May 2nd,—

Q. (Mr. Winston): Who made that record?

A. I did.

Q. Let me see that please (Referring to log-book).

Mr. Winston: If your Honor please, I don't know that this record is evidence.

Mr. Wood: I will ask him a few preliminary questions to show that this book is regularly kept, and that the entry was made.

Q. (Mr. Wood): You stated that the entry was in your own handwriting?

A. Yes sir.

Q. How soon after taking the boat in tow did you make this entry?

A. Generally about every six or eight hours.

Q. Do you recollect how soon after actually taking the boat in tow you made this entry?

A. No more than two hours anyway. It would be sometime about 8 o'clock.

Q. Is it or is it not your custom to make an entry in such cases?

A. Whenever we take a ship up we make an entry, and whenever we pass any prominent points we mark the time down.

Q. Of what did this entry consist of at that time?

A. Whenever we picked the ship up or whenever we passed any prominent points we put the time down.

Q. Did you put down the place?

A. Yes sir.

Q. Is that in that entry?

A. I suppose so.

Mr. Wood: I wish to offer that log-book in evidence.

Mr. Winston: The point in this case is to establish the place at which this towing began. I do not see how this log-book record establishes that. I object to it because it is incompetent.

The Court: Objection sustained.

Mr. Wood: I wish an exception, if your Honor please.

The Court: Exception allowed.

Q. (Mr. Wood): Do you know of your own knowledge that this point where you first picked up the bark Valley Forge was actually in British waters?

A. Yes sir, I am certain it was.

Q. Did you, after you first began towing the Valley Forge tow the Valley Forge in British waters?

A. Towed her in Vancouver shore to get the tide,—to keep the tide.

Q. State what took place.

A. I towed her up to the Vancouver shore, and then I slowed the boat down to go into Angeles in daylight, and went across slowly and went in.

Q. On what day did you reach Angeles?

A. On the morning of the 3rd.

Q. What occurred after that?

A. I anchored the ship there and went ashore and the captain of the ship went ashore, and we were there probably three or four hours, I think; and he told me he wouldn't be able to get through his business, and that he would have to go to Townsend, and he wouldn't be able to get back until Monday.

Q. What day of the week did you leave the ship there?

A. It was Sunday.

Q. Did he state any reasons?

A. He said something about his papers, I didn't ask him

what reason, but he told me he couldn't get through his business; he had to telegraph his owners.

Q. What arrangements did you make with him then?

A. I told him I had a ship in Departure Bay to take to sea, and I would go to Departure Bay and take the ship to sea and call on the way back for him, and he would probably be ready.

Q. Call for him at Port Angeles?

A. Yes sir, and then I cleared the Pilot and went to Departure Bay and done the tow I was to do.

Q. Was there anything said to you when you were about to leave?

A. Not a word. The collector gave me the clearance.

Q. Did you tow the vessel from Departure Bay to the sea?

A. Yes sir; and then cleared from Departure Bay to Port Angeles, towed the ship down and let her go.

Q. What day did you reach Port Angeles on your return?

A. On the 6th, I think.

Q. Was the tug seized on that day?

A. It was held there.

Q. For how long a time?

A. I was there about twelve or thirteen days; I came back and then he wouldn't clear me again. I came back to tow the ship Valley Forge, and I then telegraphed for another boat to British Columbia.

Q. Was she a foreign boat?

Mr. Winston: Objected to.

The Court; Sustained.

Q. Mr. Wood: Another boat came to do the work that you were to do?

A. Yes sir.

Q. And you were held?

A. I was held; or, at least, the boat was held there.

Cross-examination :

Q. (Mr. Winston): Captain, you were captain of the tug Pilot were you ?

A. Yes sir.

Q. Did you own any interest in her?

A. No sir?

Q. Did not then own any interest. or do you now ?

A. No sir, and never expect to.

Q. Will you please indicate on this chart the point at which you took up this vessel?

A. If I had anything to measure by I could come very near to it.

Q. Well, just measure.

A. I think, as near as I can judge, this would be about it. (Point where 'Valley Forge' was taken in tow by the tug Pilot indicated approximately by a black dot south of San Juan Point).

Q. What time of day was it you first picked that up?

A. When I first see them they were fifteen miles off, when I saw them first, and it would be half-past four or five o'clock when I picked them up.

Q. Where were you that morning?

A. Victoria.

Q. To go where?

A. To go seeking, with a clearance for Port Angeles

Q. You cleared from Victoria for Port Angeles to go out seeking?

A. Yes sir, as we generally used to pick up these vessels.

Q. How far is it from Victoria to the point at which you picked up this boat?

A. Probably, as near as I can judge, about fifty milés.

Q. What time did you leave Victoria, Captain?

A. I really forget ; sometime in the forenoon.

Q. Didn't you leave six o'clock in the morning?

A. Yes, but we didn't run down full speed.

Q. I didn't ask you about how fast you run. Now, you left there about six in the morning?

A. Yes sir.

Q. How fast does your tug boat run?

A. About nine knots.

Q. About nine knots; now, in five hours and a half that would bring you to the place you picked up this boat if you went right directly there?

A. Yes sir.

Q. That would bring you there about half past eleven?

A. If we went directly.

Q. Did you go directly.

A. No sir.

Q. Where did you go?

A. First when I left Victoria I saw a ship coming up by the "Race"—

Q. What is the "Race"?

A. "Race Rocks."

Q. Well, what is that?

A. (Indicating point).

Q. I understand. Go ahead.

A. A ship was coming up by the "Race." We come up from here (indicating) and went to see what ship it was.

Q. Then where did you go?

A. The ship was running up in the direction of Townsend, and after chasing her about half way up to Townsend I started for Cape Flattery again.

Q. What ship was that?

A. I didn't speak her.

Q. Why?

A. Because I saw she was bound to Townsend.

Q. You couldn't describe her? How near did you get to her?



A. Probably about four miles.

Q. How could you tell she was bound to Townsend?

A. By the way she was running; she was steering for Townsend.

Q. She may not have been going to Vancouver?

A. No sir.

Q. Nanaimo?

A. She might have after she got to Townsend.

Q. Did the captain of the bark seem to have some doubt about your right to tow him?

A. No sir.

Q. You discussed it some with him?

A. No sir; we discussed about the rates of towing and the prices.

Q. Didn't you discuss with him about your rights to take him at the point he was at?

A. He asked me if I could tow him to Departure Bay and call at Port Angeles. He asked me if I could.

Q. What do you mean?

A. I told him yes, if he was in our waters.

Q. And he told you that he was?

A. No sir. I said, "look where you are and take your position."

Q. Then you and he did go as far in this discussion as to take position to there determine whether or not you had a right to do this work?

Precisely, yes; that was the idea.

Q. You say the best you could fix it by taking an observation was that you were about four miles south-east of San Juan Point?

A. Yes sir?

Q. How wide is this strait there?

A. About twelve miles.

Q. Then you were about a mile outside of the three-mile limit?

A. No, not that far.

Q. Well you were about to the three-mile limit, and you were about three miles, according to your idea—

A. Off the shore.

Q. About the middle of the strait?

A. Yes sir.

Q. Where was the bark coming from? Captain.

A. From San Francisco; at least, I had seen her clearance from there sometime before that.

Q. Did you see any clearance papers at this time that you were seized for towing her?

A. I seen that she was from San Francisco. I knew that she was in that trade.

Q. Did you see her clearance papers?

A. No sir, I saw her clearance in the newspapers.

Q. On this voyage?

A. On the voyage I picked her up.

Q. In what paper?

A. The "Examiner."

Q. Where is that published?

A. San Francisco,

Q. What date did she clear?

A. I don't know the date; we didn't take the dates; we know the vessels are about due.

Q. What did she go to Port Angeles for?

A. Something about these papers I believe; that is what he told me, and he had to go to Port Townsend to fix them up.

Q. He had to go to Port Angeles; he told you about some paper connected with the custom-house?

A. Yes sir.

Q. At Port Angeles?

A. No, with his own papers.

Q. With his own ship's papers?

A. Yes sir; and to get papers and letters from his owners that is what he told me.

Q. Was it both or one that he was going to Port Angeles for?

A. Both.

Q. It was a mere casual call in at Port Angeles; he didn't go in there to load or unload?

A. No sir, not that I know of.

Q. Was this ship in ballast?

A. She had ballast to go to Departure Bay and load coal; she might have unloaded; I don't know whether she did or not.

Q. Now captain, when you first saw this ship, this bark, how far was she from the Cape?

A. Which Cape?

Q. Flattery.

A. Well, I couldn't tell you how far.

Q. How far was she from the ocean?

A. She was inside of Port San Juan, probably not half a mile from where I picked her up.

Q. I thought you said just now that she was fifteen miles down?

A. I didn't say from where I saw her; that is, where I first saw her.

Q. How far was she from where you picked her up when you saw her?

A. When I first saw her?

Q. Yes.

A. I couldn't tell you.

Q. How far were you from where you were when you first saw her?

A. About fifteen miles up the Straits from where I first saw her.

Q. When you first saw this boat can you state whether she was in American or British waters?

A. To the best of my knowledge she was in English waters, because there was no wind, or little if any.

Q. Can you swear positively that she was in British waters at that time?

A. Not positively because you can't tell when you are fifteen miles away.

Q. You say positively that you never saw her in the ocean?

A. Oh, no; where I was I couldn't see her in the ocean.

Q. You were not in the ocean that day?

A. No sir.

Q. And you state positively that your tug boat was not in the ocean that day?

A. She was not.

Q. Does it ever happen that these boats will go and make a bargain in American waters, and then sail over and get hitched on in British waters?

A. No sir.

Q. Did you ever hear of it before?

A. No sir.

Q. Did you ever hear it charged against any boats?

A. No sir.

Q. That is not the case with your boat?

A. No sir.

Q. Have you ever heard of that before?

A. I have heard of it about American boats.

Q. You have heard that American boat would get a British boat to come over into American waters and hook it, but never the other way?

A. Yes sir.

Q. It is not true that this boat did not go over into British water to be towed by you?

A. Not through my suggestion.

Q. Is it true that she did go over into British waters for the purpose of being towed by you?

A. Not that I am aware about.

Q. You were not a party to any such transaction, if it were true?

A. No sir.

Q. You are positive of that?

A. Positive.

Q. Did you ever tow this bark before this?

A. I think I did once.

Q. Who was her captain?

A. Bennel.

Q. Do you know whether she was under enrollment and license?

A. I couldn't say, I never seen her papers.

Q. Where did you tow her to when you towed her before?

A. Towed her from outside; somewheres from the sea.

Q. To what point?

A. To Departure Bay. She was in that trade between San Francisco and Departure Bay.

Q. When did you tow her up there? Since the 5th day of May?

A. Did I?

Q. When did you tow her to Departure Bay?

A. I think I have before and since.

Q. Did you ever tow her up to Departure Bay prior to the 5th of May?

A. I think so.

Q. Can you find it upon that book?

A. I can if it is there. (Witness referring to book.) Yes, here it is.

Q. (Referring to entry in book.) That does not say where you were carrying her to, that just says you brought her inside.

A. Perhaps not that day. Nanaimo, the next day.

Mr. Winston : That is all Captain.

Augustus Warren, a witness produced on the part of the claimant, having been first duly sworn, testified as follows :

Q. (Mr. Wood): What is your full name?

A. Augustus Warren.

Q. What is your occupation Mr. Warren?

A. I am an engineer.

Q. Were you an engineer on the tug Pilot during the month of May, 1891?

A. Yes sir.

Q. You are still the engineer of the tug Pilot?

A. Yes sir.

Q. Do you recollect picking up the bark Valley Forge on or about the 2nd day of May, 1891?

A. I do.

Q. Do you recollect any of the circumstances connected with the picking up of that bark?

A. I recollect of picking her up.

Q. About what point was that?

A. A little inside of Port San Juan.

Q. How far should you say it was from Port San Juan?

A. I should say, to the best of my knowledge she was between two and three miles from the Vancouver shore.

Q. Do you recollect the time of day?

A. I think about five o'clock, when I came on deck.

Q. Did you hear any of the conversation that took place

between the captain of the tug and the captain of the bark Valley Forge?

A. I didn't.

Q. Did you tow the bark Valley Forge about that time, soon after meeting her?

A. Yes sir.

Q. Do you recollect about how far it was that you towed her?

A. We towed her up the Vancouver shore as far as Race Rocks and crossed over.

Q. How far is that from the point of meeting?

A. It is, I think, 38 or 40 miles.

Q. Was that wholly within British waters?

A. I think so as I understand it.

Q. Where did you go then?

A. Crossed to Port Angeles with her.

Q. When did you reach Port Angeles?

A. I couldn't give you the exact time because I wasn't on watch.

Q. I mean the day?

A. I think it was on the morning of the 3rd.

Q. That was the next day?

A. Yes sir.

Q. Did you hear any conversation that took place after you reached Port Angeles, between the captain of the Pilot and the captain of the Valley Forge?

A. No, I can't say that I did.

Q. What was done by the tug Pilot after reaching Port Angeles?

A. We cleared for Nanaimo, for Departure Bay, to take a ship to sea.

Q. Did you take the ship to sea?

A. We did, yes sir.

Q. What did you do then?

A. We returned from sea to Port Angeles.

Q. What happened?

A. I was told that the boat was seized, that we were detained.

Q. How long were you detained there?

A. I think fourteen days.

Q. That is all you know of this transaction?

A. That is all.

#### Cross Examination.

Q. Mr. Winston. What were you doing when the tug hitched on to the Valley Forge?

A. I was standing on deck.

Q. Now, I ask you if it is not a fact that this Valley Forge crossed over from American waters into the British waters for the express purpose of being towed by the British tug boat?

A. I don't see how she could have, because there was no wind at the time I came on deck.

Q. I ask you if it is not a fact that when she was spoken by the tug boat she was in American waters.

A. I couldn't say; when I came on deck, about a quarter of five she was near the Vancouver shore at that time.

Q. How far was the tug boat from the ship?

A. Very close to her, about three-quarters of a mile.

Q. Don't you know it to be true that this tug boat coming down there got the ship to cross over in the British waters for the express purpose of giving you the right to tow her?

A. No sir.

Q. Do you know that is not so?

A. I don't know anything about it.

Q. That is sometimes done, isn't it?

A. I don't know; that is a thing that an engineer never troubles himself about.



Q. That is not within the province of the engineer?

A. No sir.

Re-Direct-Examination.

Q. (Mr. Wood): I would like to ask you this question: When you took the bark in tow you were to tow her to Departure Bay?

A. I understood we were, yes sir.

Q. You were so informed?

A. Yes sir.

Q. Do you know whether she went to Departure Bay? Whether the Valley Forge afterwards went to Departure Bay?

A. I saw the tug boat come in and take her out and I was told she went to Departure Bay, afterwards.

Re-Cross-Examination.

Q. (Mr. Winston): You don't know of your own knowledge whether she went to Departure Bay or Townsend, or where she went?

A. No sir. I have reason to think so because I saw her there afterwards.

Q. You don't know what the bargain was—where he was to tow her?

A. The captain told me he was to tow her to Departure Bay.

Q. Before you got to Port Angeles?

A. Yes sir.

Q. Why didn't you go straight over to Angeles after you hitched on this ship?

A. I don't know that.

Q. Sir?

A. I don't know that sir.

Q. Was there any wind that day?

A. No sir, it was very calm.

Q. Enough to fill the sails of the ship, move her along slightly?

A. I shouldn't think she could make any headway.

Q. A knot an hour?

A. No sir.

Q. Two knots?

A. No sir; I am not any sailor, and I shouldn't think she could make any headway with the wind we had.

Captain Lawrence recalled.

Q. Mr. Woods. Do you know whether the bark Valley Forge actually went to Departure Bay?

A. Yes, I know she did.

Q. I mean immediately after you were held up?

A. I towed her to sea about two weeks after that, loaded with coal.

Q. From Departure Bay?

A. Yes sir.

Q. You yourself towed her?

A. The boat that I was in.

Q. I mean the boat of which you were captain.

A. Yes sir; she was a trader; she traded there all the time; in fact she is due there now.

Q. She was plying between there and San Francisco?

A. Yes sir.

Q. Do you know whether she is due there now?

A. Yes sir; from Santiago now. She is a boat that has been engaged in that trade between both San Francisco and Santiago; she is a regular trader.

## UNITED STATES OF AMERICA.

IN THE DISTRICT COURT OF THE UNITED STATES FOR THE  
DISTRICT OF WASHINGTON, NORTHERN DIVISION.

THE UNITED STATES	}
<i>Libelant,</i>	
vs.	
THE STEAM TUG PILOT, Her Steam-	}
ers, Engines, Boilers, Etc.,	
<i>Claimant.</i>	

Continuation of trial before Hon. James Kiefer, United States Commissioner, October 3rd, 1891.

United States Attorney Patrick H. Winston, for the libelant and Messrs. Burke, Shepard & Wood, for the claimant.

John J. Bennett, a witness called on the part of the claimant, having been first duly sworn, testified as follows :

Q. (Mr. Wood): Captain, are you the captain of the Valley Forge?

A. I am.

Q. Were you captain of the Valley Forge in May, 1891?

A. Yes sir.

Q. During the month of May, 1891?

A. Yes sir.

Q. Do you remember coming through the Straits of San Juan De Fuca about the 2nd of May, 1891.

A. Yes sir.

Q. Did you meet the tug boat Pilot in the Straits of San Juan De Fuca on that day?

A. Yes sir.

Q. Do you recollect about the point that you met the tug Pilot?

A. Yes sir.

Q. Where was that point?

A. Off the entrance of San Juan harbor.

Q. Port San Juan?

A. Yes sir.

Q. How far is that inside the Straits?

A. I should judge about ten or twelve miles; about that.

Q. Were you and the Valley Forge at that time in British waters?

A. Yes sir.

Q. How wide is the Strait at that point?

A. I should judge about twelve miles.

Q. About how far were you from San Juan?

A. About three miles.

Q. Port San Juan is on Vancouver's Island?

A. Yes sir.

Q. And about how far inside of the Straits from the sea?

A. I should judge between ten or twelve miles.

Q. Do you recollect what time it was when you met the Pilot?

A. I think it was somewhere between four and five in the afternoon; I could not recollect exactly.

Q. That was the first you saw of her?

A. I saw her coming down the Straits before that, probably an hour or an hour and a half before.

Q. Before she actually spoke to you?

A. Yes sir; it was a clear day and I could see her a long ways.

Q. Were you in British waters all the time?

A. No sir; I was beating from one shore to the other.

Q. Was there very much wind at that time?

A. No sir; only a moderate breeze.

Q. What took place when the tug spoke you?

A. He came up along side and asked me where I was bound to, and whether I wanted a tug; and I told him I was bound to Nanaimo to load with coal.

Q. Did you make a contract?

A. Yes sir.

Q. What was that contract?

A. To tow me to Nanaimo, and back to sea by way of Port Angeles.

Q. About how much was paid for that towing?

A. It was between six and seven hundred dollars.

Q. Did the Pilot take you in tow then?

A. Yes sir.

Q. And what was the course that you followed?

A. Well, we towed up close to the Vancouver shore.

Q. How far did you run in British waters?

A. We went up very near to Race Rocks.

Q. How far is that do you think?

A. I don't know exactly; I suppose it is forty miles, ai'nt it; somewheres in that neighborhood; I wouldn't say exactly.

Q. Then where did you go?

A. Then we went across to Port Angeles.

Q. You went across, or the Pilot towed you across, at your request?

A. Yes sir.

Q. After you got to Port Angeles you were unable to go on, were you?

A. Yes sir; I had to go to Port Townsend for to get a register.

Q. And did the captain of the Pilot leave you then?

A. Yes sir.

Q. And the Pilot cleared?

A. The Pilot cleared ; I suppose she went away ; she was to tow another vessel to sea.

Q. You understood that she was to tow another vessel to sea ?

A. Yes sir ; I understood that she was to tow another vessel to sea, and then take me back.

Q. Do you know what happened ?

A. Yes sir ; she was seized then.

Q. By whom ?

A. By the deputy collector.

Q. Do you know for what she was seized ?

A. She was seized for towing me in there to Port Angeles.

Q. The contract was to tow you from the point where you met to Port Angeles, then to Departure Bay, and from there to sea ?

A. Yes sir.

Q. The Pilot did not tow you out of Port Angeles ?

A. No sir ?

Q. The Pilot was held there ?

A. Yes sir.

Q. What boat did tow you out ?

A. The boat Lorne.

Q. From there where did you go ?

A. To Departure Bay.

Q. Who towed you out to sea ?

A. The Lorne.

Q. You did not go up the Sound at all ?

A. No sir.

Q. You did not come into any American Port except Port Angeles ?

A. No sir.

Q. Did you load anything at Port Angeles ?

A. No sir.

Q. You were in ballast ?

A. Yes sir.

Q. And you continued in ballast until you got to Nanaimo?

A. Yes sir—Departure Bay.

Q. When you got to Nanaimo what did you load with?

A. Coal.

Q. From what port?

A. San Francisco.

Mr. Wood: I think that is all for the present.

#### Cross-Examination.

Q. (Mr. Winston): When the Valley Forge left San Francisco she was not a registered vessel, was she?

A. No sir, not at the time; she was a documented vessel.

Q. Sailing under a twelve months' license?

A. Yes sir.

Q. Coastwise?

A. Yes sir.

Q. She did not have to clear when she left San Francisco?

A. No sir, she didn't have to.

Q. So when you left San Francisco you left to go to Port Angeles there to [stop until you could have your ship registered?

A. Yes sir.

Q. And after you had her registered you intended to leave Port Angeles for Nanaimo?

A. Yes sir; that is correct.

Q. You did not intend to go to Nanaimo without clearing?

A. No sir.

Q. You entered the Straits and beat along the Straits,—tacking.

A. Yes sir

Q. And when you tacked over to the British side you met the tug?

A. Yes sir. That is correct.

Q. You are sure it was not on the American side?

A. I am sure it was on the English side.

Q. Did you ever hear of a custom—well, I'll hardly call it a custom, but did you ever hear of ships being on the American side and then sailing over to the British side to be hitched on in order to avoid the American Navigation laws?

A. Well, I don't know of any, but I have heard of it but didn't know of it myself. I saw the tug Pilot coming down the Straits.

Q. You didn't know where she was coming from?

A. No sir, I didn't know where she was coming from.

Q. Let me see if I understand this: The Valley Forge, an American ship, not registered, but under coasting license, in your command, started from San Francisco to Port Angeles for the purpose of stopping there until you could go to Port Townsend and take out a registry—

A. Yes sir.

Q. —and then come back and clear from Port Angeles and go to Nanaimo—

A. Yes sir.

Q. —was picked up by the British tug Pilot in the Straits over on the British side where she had tacked over to catch the wind?

A. Yes sir.

Q. Is that correct?

A. Yes sir.

Mr. Winston: That is all.

Q. (Mr. Wood): Had the tug Pilot ever towed you before into Departure Bay?

A. Yes sir.

Q. I mean before May, 1891?



Mr. Winston: Wait a minute, brother. I believe it is necessary to take exceptions in order to save these exceptions, and I except to that question.

A. Yes sir.

Q. (Mr. Wood): Has the tug pilot ever towed you into Departure Bay since May, 1891?

Mr. Winston: Exception.

A. Since May?

Q. (Mr. Wood): Yes.

A. No sir. Not since May.

Q. Do you recollect the day when the tug Pilot was seized,—the day of the month?

A. I think it was on the 5th.

Q. Do you recollect what day of the week that was?

A. Yes sir; but let's see,—I came in on Sunday, the 3rd. Monday was the 4th, Tuesday was the 5th. It was on Tuesday I think.

Q. You are sure?

A. No sir, I am not sure.

Q. The 5th might have been Monday?

A. No sir, I am not sure of that.

Q. The Valley Forge has been engaged in the coal business, has it,—carrying coal back and forth between Nanaimo and California.

Mr. Winston: Please enter an exception to that question.

A. Yes sir.

(Mr. Wood): How long have you \*been captain of the Valley Forge?

A. I have been captain of the Valley Forge since the 17th of September, last year.

Q. Of 1890?

A. Yes sir.

Q. And you have been on the run from California to Nanaimo ever since?

Mr. Winston; Exception entered.

A. Yes sir.

Mr. Wood: That is all, Captain.

Q. (Mr. Winston): Do I understand you to say that you have been trading between San Francisco and Nanaimo under a coastwise license?

A. No sir; under a registry.

Q. The time you went to Nanaimo, as spoken of by counsel, this was a registered ship, and it was cleared?

A. Yes sir.

Q. You never undertook to go from San Francisco to Nanaimo when the ship was not registered?

A. No sir:

James Christenson, a witness called on the part of the claimant, having been first duly sworn, testified as follows:

Q. (Mr. Wood): Are you the captain of the tug Lorne?

A. Yes sir.

Q. How long have you been captain of the Lorne?

A. Since March, 1891.

Q. Where does the tug Lorne belong?

A. In Victoria.

Q. You were captain of the tug Lorne in May, 1891?

A. Yes sir.

Q. Did you on or about May 5th tow the bark Valley Forge from Port Angeles to Nanaimo?

Mr. Winston: Objected to.

A. Yes sir.

Q. (Mr. Wood): And you actually reached Nanaimo with the Valley Forge.

Mr. Winston: Objected to.

A. Yes sir.

Q. (Mr. Wood): Do you know whether or not the Valley Forge came to any port on Puget Sound?

A. No sir, I do not.

Q. Did you tow the bark Valley Forge from Nanaimo to the sea?

Mr. Winston: Objected to.

A. Yes sir.

Q. (Mr. Wood): Do you know whether the tug Pilot was detained at Port Angeles?

A. Yes sir; I do.

Q. Do you know why the tug Pilot was detained at Port Angeles on May 5th?

Mr. Winston: Objected to.

Mr. Wood: I will withdraw that; that is not material.

Q. (Mr. Wood): You know that the tug Pilot was actually detained?

A. Yes sir.

Q. Where did the tug Pilot belong?

A. Victoria.

Q. I presume captain, you saw nothing of the matter in in the Straits.

A. No sir.

Q. All you know about the transaction is—you don't know anything at all about this transaction?

A. No sir.

Mr. Wood: That is all.

Cross Examination.

Q. (Mr. Winston.) What is the name of your tug boat?

A. The Lorne.

Q. You came over from Victoria to Port Angeles?

A. Yes sir.

Q. On what date, sir?

A. Fifth.

Q. Fifth of what?

A. May.

Q. Of this year?

A. Yes sir.

Q. And there hitched on to the bark Valley Forge?

A. Yes sir.

Q. And towed her from Port Angele to Nanaimo?

A. Yes sir.

Q. Where is the Lorne now?

A. Seattle.

Mr. Winston: That is all, sir.

Thomas Lawrence, a witness called on the part of the claimant having been first duly sworn testified as follows:

Q. Mr. Wood. Captain Lawrence, in your cross-examination, when you were examined before Judge Hanford, you testified to leaving Victoria and running down towards Port Townsend. I wish you would explain that—on the morning of May 2.

A. I didn't run down towards Port Townsend when I left Victoria.

Q. Account for your time during that day.

A. I got down to Race Rocks and I saw a ship running up the Straits—probably ten or twelve or fifteen miles up the Straits. I headed the boat up after the ship for probably an hour or an hour and a half, and then I saw that the ship was headed towards Port Townsend, and then I could tell by that that she was bound into Port Townsend, or somewhere on the American side, and I knew that there was no use going after her, and I then turned back and run down the Straits.

Q. How far are Race Rocks from Victoria?

A. They are south between nine and ten miles.

Q. How long a time did that consume?

A. It would take me an hour or a little better to go down to the Race, and run back in an hour and a half—it would be about four hours or so.

Q. What did you do after that?

A. We started down the Straits and I saw a ship on one side

Q. You have testified that you sighted this Valley Forge about fifteen or twenty miles away.

A. Probably about fifteen miles; it was a clear day.

Q. At the time you saw her you were quite a long distance down the Straits?

A. Yes sir.

Q. Now I wish you would explain your location. I think your location as you explained it before—there was one instance in your examination-in-chief, you said you were at “the east point of San Juan, bearing southwest four miles.”

A. Northwest; four miles off San Juan.

Q. And what was that—how far distant was that from the Vancouver shore?

A. That would bring her three or two and three-quarters off the land; that is to the best of my judgment; we couldn't measure the distance exactly.

Q. What was the day of the month that you were seized?

A. We were seized on the 5th, if I remember rightly.

Q. Did you know anything about the papers of the Valley Forge, Captain?

A. No sir.

Q. You did know that the Valley Forge had loaded coal in Nanaimo?

A. I knew that she had been trading there.

Q. You had towed that same boat before, had you not?

A. Yes, that is, while I was master of the boat, and I think she had towed her before while I was mate of her.

Q. And you kept the log-book at that time?

A. Yes sir. There was an old log-book that was kept before by Captain Hill.

Q. The tug Pilot was tugging (towing) into Nanaimo before 1891?

A. Yes sir.

Q. Do you recollect whether you ever towed them before in 1891?

A. I think I have once since, but I won't be certain.

Q. From Nanaimo?

A. Yes sir. We could hardly remember all the ships that we tow, but I think I have towed her once; the log-book will show all right. I think I have towed her once to sea.

Q. Now, I want you to explain, Captain, why it was, from the point of meeting, you went down along the Vancouver shore thirty miles?

A. Now, on one side of the Straits the tide will run stronger than on the other at times. If it is ebb tide we keep the American shore, if on the flow, the Vancouver shore; whichever way we can make the quickest time.

Q. From the point of meeting, I think you said you towed the Valley Forge thirty miles in British waters?

A. Probably more than that.

Q. How much more?

A. I think within two or three miles of the Race.

Q. And you said these were nine miles south of Victoria?

A. Yes sir.

Q. And when you got to that point, at the request of the captain you run over to Port Angeles?

A. He didn't request it then, but that was the agreement.

Q. And you did strike across to Port Angeles?

A. After getting up there, yes.

Q. You expected to go right on to Departure Bay?

A. As soon as he went in there and he fixed his business up.

Q. You don't know that the Valley Forge loaded or unloaded there?

A. I didn't see anything.

Q. That is the usual way of coming in when the tide is in the condition it was when you were in there?

A. Yes sir, it is according to the tide.

Q. You could make better time?

A. Yes sir, sometimes we go down the Vancouver shore and sometimes down the American shore.

Q. It was more favorable at that time for you to go up that way?

A. Yes sir.

Q. How heavy was this tow?

A. A ship of about thirteen or fourteen hundred tons?

Cross-Examination.

Q. (Mr. Winston): When you left Victoria to go to the point at which you hitched on to this bark would you shape your course to this Race?

A. You go south to go to Race Rocks and west going down the Straits.

Q. In going down the Straits you do not ordinarily go past Race Rocks?

A. Yes sir.

Q. When you are on your regular route from Victoria to the sea?

A. Yes, but not from Victoria; we were bound up the Straits. We left—

Q. I want to ask you if you were going from Victoria to Port San Juan would you go by Race Rocks from Victoria?

A. If we were bound there?

Q. Well, if you were bound there?

A. Yes sir.

Q. You understand my question?

A. Yes sir.

Q. (Counsel and witness referring to map): Show me Race Rocks there.

A. I sighted the ship over about where the A in the word "Fuca" is on the map. That is the first ship you know; not the Valley Forge; we didn't sight her there.

John J. Bennett, recalled.

Q. (Mr. Wood): You recollect Captain Bennett, that the Pilot did tow you once after May, 1891?

A. To sea.

Q. From what point to what point?

A. From sea; that was three voyages ago.

Q. If you can recollect.

A. It is every month with us and there is so much of it.

Q. You have been accustomed to be towed back and forth from Nanaimo to sea?

A. Yes sir.

Q. By British tugs?

A. Yes sir, and American tugs, too.

Q. And American tugs?

A. Yes sir; whichever come the handiest.

Q. Do the American tugs tow upon your side, too?

A. Yes sir.

Mr. Wood: That is all.

(At this point Mr. Winston directed several interrogatories to Captain Thomas Lawrence, not having recalled him to the stand formally, in relation to American tugs towing from point to point in British waters, and your reporter, imagining it was more for the purpose of information to counsel than for record, failed to take the same. District Attorney Winston then followed with the following questions, and requested that they be noted):

Q. You say that American boats tow in British waters from one place to another in British dominion?



A. Yes sir; if they take the boat in American waters they do.

Q. You mean to say that American tow boats tug from American waters over to British waters?

A. Yes sir.

Q. And that is all you mean to say?

A. Yes sir.

Cross-Examination of Witness John J. Bennett.

Q. (Mr. Winston): You say that this tug boat has towed you not very long ago from Nanaimo to sea?

A. Yes sir.

Q. Now I will ask you if when she did that if yours was not a registered boat?

A. Yes sir.

Q. And if you did not clear from Nanaimo for San Francisco?

A. Yes sir.

Q. And Nanaimo is in British waters?

A. Yes sir.

Q. And she is a British tug boat?

A. Yes sir.

Q. And she hitched on to you at a British custom house?

A. Yes sir.

Q. And you were bound to an American port?

A. Yes sir.

Mr. Winston: That is all.

Mr. Wood: I object to this examination in relation to towing from a British port out to sea; I object to these general questions about British tug boats towing from Nanaimo to sea when the boat goes to California.

Re-Direct Examination.

Q. (Mr. Wood): The tug Lorne—I believe you answered this before—the tug Lorne hitched on to you at Port Angeles and towed you to Nanaimo?

Mr. Winston , Objected to.

A. Yes sir.

Q. And that was before you were a registered vessel ?

A. Yes sir, I was registered.

Q. You were a documented vessel ?

A. Yes sir, but I got my registry at Port Townsend. Port Angeles was not a full port of entry at that time.

Q. That towing was partly in British waters ?

A. Yes sir.

Q. Captain, do not British tug boats tow American documented vessels from Port Angeles, and other ports in that vicinity, bound to San Francisco ?

Mr. Winston : Objected to.

A. Documented vessels ?

Q. Yes.

A. I couldn't say ; I don't know.

Q. A documented vessel that loaded lumber on the American side for instance—a documented vessel would not go on the British side ?

Q. (Mr. Winston): As she was tacking ?

A. Oh, yes, she could sail on their waters.

Q. (Mr. Wood): Did you ever hear of an American tug boat towing from sea into a British port ?

A. Yes sir.

Q. You have been towed that way yourself ?

Mr. Winston : Objected to.

A. Yes sir.

Q. (Mr. Wood). And from American waters into a British port ?

A. Yes sir.

Re-Cross examination.

Q. (Mr. Winston): Captain, did you ever hear of an American tug boat being seized over in British Columbia, and condemned over there by the Courts, for towing in British waters.

Mr. Wood. I object to that question.

A. They had some trouble here a short time ago about some tug boats towing some scows.

Q. Don't you know that one of them was seized in the Courts and by thy Courts?

Mr. Wood: Objected to.

A. I don't know any of the particulars about it, but I have heard of it.

Q. I don't want the particulars; I want to know if you do not know as a common fact that an American boat was seized there and condemned in the Courts?

(Mr. Wood): Objected to as immaterial.

A. Yes sir, I have.

Q. (Mr. Wood): Do you know the name of that boat? Do you know the name of any such boat? It was not the tug Pilot, was it?

A. No sir.

Q. Do you know the name of the boat?

A. Which? The American boat?

Q. Yes.

A. The Mogul.

Q. The Mogul?

A. Yes, she was one, and the other was the Frost. I don't recollect anything much about it.

Q. You don't know anything about the circumstances?

A. No sir, I don't know anything about it.

(Mr. Winston): Is that all, Mr. Wood?

(Mr. Wood): That is all, yes sir.

Q. (Mr. Winston): What papers was your boat sailing under, the Valley Forge?

A. She was under enrollment and license.

Testimony closed.

DISTRICT OF WASHINGTON.—ss.

I, James Kiefer, U. S. Commissioner, do hereby certify that the foregoing is a true and correct transcript of the testimony taken in above case before me this 3rd day of October, 1891.

JAMES KIEFER,  
*U. S. Commissioner.*

UNITED STATES DISTRICT COURT, DISTRICT OF WASHINGTON,  
NORTHERN DIVISION.

THE UNITED STATES OF AMERICA,	}	Opinion filed October 30, 1891.
vs.		
THE STEAM TUG PILOT, ETC.		

IN ADMIRALTY.

P. H. Winston, U. S. Attorney, *for Libellant.*  
Burke, Shepard & Woods, *for Claimant.*

Hanford, J:—

This is a case of seizure to enforce a penalty imposed by Section 4370 U. S. R. S. The facts are as follows: The Pilot, is a British Steam tug engaged in the business of towing upon the Strait of Juan de Fuca, and other waters of this State and British Columbia. The bark Valley Forge, is an American enrolled vessel of 1286 tons burden engaged in coast wise trade, and being bound on a voyage from San Francisco to Port Angeles, entered the Straits without assistance, and was beating against a headwind toward her port and destination. The Pilot found her on the north side of the Strait and within three miles of the shore of Vancouver Island, near Port San Juan, where she had sailed upon her port tack, and towed her across the Strait to Port Angeles pursuant to a contract made with her master at the time, to tow the Valley Forge, first to Port Angeles, thence to Departure Bay in British Columbia, to load and thence to sea. The Valley Forge, remained at Port Angeles while her master went to the custom house at Port Townsend, for the purpose of exchanging her certificate of enrollment for a register to entitle her to clear for a foreign port, and she was afterwards towed from Port Angeles to Departure Bay, by a

British tug, under the contract made with the master of the Pilot.

Section 4370, R. S, is the same as the twenty-first section of the act of July 18, 1866, entitled "An act to prevent smuggling and for other purposes." (14th U. S. Statutes 183,) as amended by the act of 1867 found on page 410 of the same volume. It reads as follows :

"Sec, 4370. All steam tug boats not of the United States found employed in towing documented vessels of the United States plying from one port or place in the same to another, shall be liable to a penalty of fifty cents per ton on the measurement of every such vessel so towed by them respectively which sum may be recovered by way of libel or suit. This section shall not apply to any case where the towing in whole or in part is within or upon foreign waters. \* \* \*"

Originally the section contained no exceptions, the last clause was added by the amendatory act.

The exact question now presented for decision is this ; Does the mere fact that a vessel is making a passage of the Strait crosses the inter-national boundry line, legalize a towage service which would be a violation of Section 4370 if performed wholly on the American side?

This Strait is an arm of the sea wholly within the jurisdiction of the United States and Great Britain, as part of the territory of the two countries, and is not like the open ocean, a free highway for the ships of all nations. By treaty stipulations the boundry between the two countries is upon a line following the middle of the Strait, and all that part of it north of the middle is British water, and all south of the line is American water. But by the treaty the entire Strait is free and open to both countries for purposes of navigation so that the vessels of each are free to sail anywhere in the Strait upon either side of the line. It is my opinion that while this treaty remains, no part of the Strait

can be regarded as *foreign waters* to either American or British vessels. The Appollon, 9th Wheaton, 362. And further that the term "foreign waters" as used in section 4370 means water under the exclusive dominion of a foreign government for all purposes. My conclusion is that foreign tugs are not privileged to tow American vessels bound from one American port to another on either side of the Strait. And that a penalty has been incurred by the tug Pilot as charged in the libel in this case.

C. H. HANFORD,

*Judge.*

IN DISTRICT COURT OF THE UNITED STATES FOR THE  
DISTRICT OF WASHINGTON, NORTHERN DIVISION.

THE UNITED STATES,

vs.

STEAM TUG PILOT, her tackle,  
apparel, furniture, etc.

} Findings of Fact.

This cause coming on to be heard this 6th day of October, 1891, in open Court, the Court upon the evidence introduced upon the trial of said cause, makes the following findings of fact:

1. That the said steam tug Pilot, during all the times mentioned in the libel, was and is a British steam tug, engaged in the business of towing upon the Straits of Juan de Fuca and other waters of the State of Washington and British Columbia.

2. That the bark Valley Forge, during all the time mentioned in the libel, was and is an American enrolled vessel of 1286 tons burden, engaged in coastwise trade, on the Pacific coast. That on May 3, 1891, the said bark Valley Forge was bound on a voyage from San Francisco, California, to Port Angeles, in the State of Washington, and

upon said voyage entered said strait of Juan de Fuca without assistance, and was beating against a headwind toward her port of destination.

3. That the said tug Pilot found the said bark Valley Forge on the north side of said Strait, and within three miles of the shore of Vancouver Island, near Port San Juan, where she had sailed upon her port tack, and the Pilot then towed her across the Strait to Port Angeles, a contract being made at the time with the master of said Valley Forge, that she should be towed by the said tug Pilot, first, to Port Angeles, thence to Departure Bay, in British Columbia, to there load, and thence again to sea.

4. That the Valley Forge remained at Port Angeles while her master went to the Customs House at Port Townsend, in the customs district of Puget Sound, for the purpose of exchanging her certificate of enrollment for a register, in order that she might be entitled to clear from a foreign port.

5. That the Valley Forge was afterwards towed from Port Angeles to Departure Bay by another British steam tug under the contract made with the master of said Pilot.

6. That the said vessel Valley Forge, in making its passage of the said strait, crossed the international boundary line between the United States and British Columbia.

7. That the said tug Pilot was not at the time it did the towing, as aforesaid, or at any time, a tug boat of the United States, but it was a tug boat owned by foreigners residing at Victoria, British Columbia.

8. That the said tug boat Pilot, by reason of doing the said towing as aforesaid, became liable to a penalty of \$643.

9. That on May 5, 1891, upon the waters of Puget Sound, and within the customs district of said Puget Sound, and within the northern division of said district of Wash-



ington, the Hon. C. M. Bradshaw, the duly qualified and acting collector of customs of said district of Puget Sound, did seize and take into his possession as being forfeited to the United States the said steam tug Pilot, her engines, boilers, machinery, tackle, apparel, furniture, etc., for having towed said Valley Forge, as aforesaid, after said Pilot had done the towing, as aforesaid; and, before the filing of the libel of information herein, the said collector of customs assessed a penalty of \$50 per ton of the tonnage of the bark Valley Forge against the said steam tug Pilot, her said engine, boiler, machinery, tackle, etc., which penalty has not been paid.

10. That at the time of the filing of the libel in this case, the said collector of customs aforesaid, still held said Pilot, her engine, boilers, machinery, tackle, etc., in his possession, under said seizure, and she has been duly attached and taken into the custody of the United States Marshal under the warrant issued from this Court.

11. That after the arrest of the Pilot by the Marshal, as aforesaid, her master Thomas Lawrence in behalf of her owner filed a claim and also a stipulation in the sum of two hundred and fifty dollars, with J. Keith Wilson and Robert Croft as sureties conditioned to pay all costs that may be decreed to be paid by said claimant and also a further stipulation in the sum of fifteen hundred dollars with R. Lea Barnes and Robert Croft as sureties conditioned to abide by and satisfy the decree herein.

12. That upon the filing of said claim and stipulations the Pilot was by order of the Court released from custody.

C. H. HANFORD,  
*Judge.*

And on the back of the foregoing is endorsed the words and figures following:

UNITED STATES,	}	No. 259. Findings of Facts.
vs.		
STEAM TUG PILOT.		

Filed Nov. 24, 1891, in the U. S. District Court.

R. M. HOPKINS,  
*Clerk.*

IN THE UNITED STATES DISTRICT COURT FOR THE DISTRICT  
OF WASHINGTON, NORTHERN DIVISION.

THE UNITED STATES	}	Decree.
vs.		
STEAM TUG PILOT, Her Tackle, Apparel, Furniture, Etc.		

Now, on this 24th day of November, 1891, the said Court having made its findings of fact in the said cause; and it appearing therefrom that said steam tug Pilot, her engines, boilers, machinery, tackle, etc., is subject to a penalty of \$643, for violation of Section 4370 of the Revised Statutes of the United States, which penalty has already been assessed

by Hon. C. M. Bradshaw, Collector of Customs for the District of Puget Sound, against the said steam tug Pilot, her engines, boilers, machinery, tackle, apparel, furniture, etc., and, it further appearing that Joan Olive Dunsmuir has duly made claim to be the owner of the said steam tug Pilot, her tackle, apparel, etc.; and that said claimant has also entered into a bond for the release of said vessel, with R. Lea Barnes and Robert Croft as sureties,

It is, therefore, ordered, adjudged and decreed that the United States do have and recover of and from said claimant Joan Olive Dunsmuir on said bond, the sum of (\$643) six hundred and forty-three dollars, with costs of the libel; and, if the said claimant do not within twenty days from the date hereof pay into Court said sum of six hundred and forty-three dollars, together with said costs judgment shall be entered upon the said bond, on motion in open Court, without further delay, against the sureties named in said bond.

C. H. HANFORD,  
*Judge.*

And on the back of the foregoing is endorsed the words and figures following:

UNITED STATES	}	259. Decree.
vs.		
STEAM TUG PILOT.		

Filed Nov. 24, 1891, in the U. S. District Court.

R. M. HOPKINS,  
*Clerk.*

IN THE DISTRICT COURT OF THE UNITED STATES FOR THE  
DISTRICT OF WASHINGTON, NORTHERN DIVISION.

IN ADMIRALTY.

UNITED STATES,	}	Decree.
vs.		
THE STEAM TUG PILOT, her Tackle, Apparel, Furniture, etc.,		
JOAN OLIVE DUNSMUIR, <i>Claimant.</i>		

A decree having heretofore been made and entered herein on the 24th day of November, 1891, by which it was adjudged and decreed that the United States do have and recover of the claimant of the steam tug Pilot, to-wit: of Joan Olive Dunsmuir, on her bond heretofore given by her for the release of said vessel, the sum of six hundred and forty-three dollars (\$643) for violation of section 4370 of the Revised Statutes of the United States, and it being provided in said decree that if the said claimant do not within twenty days from the date thereof pay into this Court the said sum of \$643, with costs of this action, then and in that event judgment should be entered upon said bond against the sureties therein named without further delay; and the claimant herein, the said Joan Olive Dunsmuir, having neglected and failed to pay into this Court the aforesaid sum of \$643, within twenty days from the date of said decree, as in said decree provided, and the said twenty days having long since expired,

Now, on application of P. H. Winston, Esq., United States District Attorney for the District of Washington,

It is ordered, considered, adjudged and decreed that the United States do have and recover of and from Joan Olive Dunsmuir the principal in said bond named and against R. Lea Barnes and Robert Croft, the sureties on said bond of the claimant herein, the sum of six hundred and forty-three dollars (\$643) together with costs of the libelant herein.

And it is further ordered that unless an appeal be taken from this decree within the time limited by law, and prescribed by the rules and practice of this Court, the libelant have execution to enforce satisfaction thereof.

C. H. HANFORD,  
*District Judge.*

Dated, Seattle, Dec. 18, 1891.

And on the back of the foregoing is endorsed the words and figures following :

U. S. DISTRICT COURT FOR DISTRICT OF WASHINGTON, NORTH-  
ERN DIVISION.

UNITED STATES,	}	No. 259. Final Decree.
vs.		
THE STEAM TUG PILOT, Her Tackle, etc.		

BURKE, SHEPARD & WOODS,  
*Proctors for Claimant.*

Filed this Dec. 18, 1891.

R. M. HOPKINS,  
*Clerk.*

IN THE DISTRICT COURT OF THE UNITED STATES FOR THE  
DISTRICT OF WASHINGTON, NORTHERN DIVISION.

UNITED STATES, <i>Libelant,</i>	}	Claimant's Exceptions.
vs.		
THE STEAM TUG PILOT, her tackle, apparel, furniture, etc., <i>Respondent.</i>		
and JOAN OLIVE DUNSMUIR, <i>Claimant.</i>		

Now comes Joan Olive Dunsmuir, the claimant of the steam tug Pilot, by Messrs Burke, Shepard & Woods, her proctors in admiralty, and excepts to the findings of fact heretofore made and filed by the Court in this cause and to the decrees against said Joan Olive Dunsmuir, and the sureties on her bond as follows :

1. She excepts to that part of the second finding of fact commencing at the third line thereof, which states that "the said bark Valley Forge was bound on a voyage from San Francisco, California, to Port Angeles in the State of Washington."

2. She excepts to that part of the third finding of fact commencing at the fourth line thereof, which states, "and the Pilot then towed her across the Strait to Port Angeles, a contract being made at the time with the master of said Valley Forge that she should be towed by the said tug Pilot first to Port Angeles, thence to Departure Bay in British Columbia to there load, and thence again to sea."

3. She excepts to the eighth finding, and to each and every part thereof.

4. She excepts to the decree made and entered by the Court in this cause on the 24th day of November, 1891, by which it was adjudged and decreed that she pay the sum of \$643 within twenty days from the date of said decree, and to each and every part thereof.

5. She excepts to the final decree in this cause made and entered herein on the 18th day of December, 1891, and to each and every part thereof.

BURKE, SHEPARD & WOODS,  
*Proctors for Claimant.*

And on the back of the foregoing is endorsed the words and figures following :

DIST. COURT OF THE U. S., DIST. OF WASH., NORTHERN  
DIVISION.

UNITED STATES,

vs:

STEAM TUG PILOT, etc.

JOAN OLIVE DUNSMUIR,  
*Claimant.*

} No. 259.  
} Claimant's Exceptions.

BURKE, SHEPARD & WOODS,  
*Proctors for Claimant.*

Filed this Dec. 26, 1891.

R. M. HOPKINS,  
*Clerk.*

IN THE DISTRICT COURT OF THE UNITED STATES FOR THE  
DISTRICT OF WASHINGTON, NORTHERN DIVISION.

UNITED STATES OF AMERICA,

*Libellant.*

vs.

THE STEAM TUG PILOT, Her Steam  
Engines, Boilers, Machinery,  
Tackle, Apparel, Furniture, Etc.,

*Respondent,*

and JOAN OLIVE DUNSMUIR,

*Claimant.*

} Notice of Appeal.

*Sirs:* Please to take notice that the claimant, Joan Olive Dunsmuir, hereby appeals to the Circuit Court of Appeals for the Ninth Circuit from the decree of the District Court of the United States for the District of Washington, Northern Division, and every part of said decree. entered on the 18th day of December, 1891, and prays that the records and proceedings herein may be returned to said Circuit Court of Appeals and that said decree may be reversed, or such other decree may be made as to said Circuit Court of Appeals shall seem just. Yours, etc.,

BURKE, SHEPARD & WOODS,  
*Proctors for Claimant.*

*To Patrick Henry Winston, Esq., United States District Attorney,  
and to R. M. Hopkins, Esq., Clerk of the District Court.*



And on the back of the foregoing is endorsed the words and figures following:

UNITED STATES DISTRICT COURT FOR DISTRICT OF WASHINGTON, MORTHERN DIVISION.

UNITED STATES OF AMERICA,	}	No. 259.
<i>Libelant,</i>		
vs.		
THE STEAM TUG PILOT, etc.,		
<i>Respondent.</i>	}	Notice of Appeal.
JOAN OLIVE DUNSMUIR,		
<i>Claimant.</i>	)	

BURKE, SHEPARD & WOODS,  
*Proctors for Claimant.*

Filed this Dec, 26, 1891.

R. M. HOPKINS,  
*Clerk.*

Service of within paper on the undersigned this 26th day of December, 1891, is hereby admitted.

P. C. SULLIVAN,  
*Assistant U. S. District Attorney.*

IN THE CIRCUIT COURT OF APPEALS FOR THE NINTH  
CIRCUIT.

UNITED STATES OF AMERICA,	}	Assignment of Error.
<i>Libelant,</i>		
vs.		
STEAM TUG PILOT, her engines, boilers, tackle, furniture, etc.,		
<i>Respondent.</i>		
JOAN OLIVE DUNSMUIR,	}	
<i>Claimant.</i>		

1. The Court below, the District Court of the United States for the District of Washington erred in finding as a fact "that on May 3, 1891, the said bark Valley Forge was bound on a voyage from San Francisco, California, to Port Angeles, in the State of Washington, and upon such voyage entered said Strait of Juan de Fuca without assistance and was beating against the head wind toward her port and destination."

2. The said Court erred in finding as a fact "that the said tug Pilot \* \* \* then towed her (the bark Valley Forge) across the Strait to Port Angeles, a contract being made at the time with the master of said Valley Forge that she should be towed by said tug Pilot first to Port Angeles, thence to Departure Bay in British Columbia, and to there load and thence again to sea."

3. The said Court erred in finding as a fact "that the said tug Pilot by reason of towing the said bark Valley Forge as aforesaid became liable to the penalty of \$643."

4. The said Court erred in entering the decree of November 24, 1891, "that the United States do have and

recover of and from said claimant Joan Olive Dunsmuir on said bond the sum of \$643., with costs of libelant.

5. The said Court erred in entering the decree of December 18, 1891, "that the United States do have and recover of and from Joan Olive Dunsmuir the principal in said bond named, and R. Lea Barnes and Robert Croft, the sureties on said bond of the claimant herein, the sum of \$643, together with costs of the libelant herein."

6. The said Court erred in not dismissing the libel herein.

BURKE, SHEPARD & WOODS,  
*Proctors for Appellant.*

And on the back of the foregoing is endorsed the words and figures following :

IN CIRCUIT COURT OF APPEALS FOR THE NINTH CIRCUIT.

UNITED STATES OF AMERICA,	}	No. 259.
<i>Libelant,</i>		
vs.		
STEAM TUG PILOT, etc.,	}	Assignment of Error.
<i>Respondent,</i>		
JOAN OLIVE DUNSMUIR,		
<i>Claimant.</i>	)	

BURKE, SHEPARD & WOODS,  
*Proctors for Claimant.*

Service of the within paper on the undersigned, this 31st day of Dec., 1891, is hereby admitted.

P. C. SULLIVAN,  
*Asst. U. S. District Attorney.*

Filed this Dec. 31, 1891.

R. M. HOPKINS,  
*Clerk.*

IN THE DISTRICT COURT OF THE UNITED STATES FOR THE  
DISTRICT OF WASHINGTON, NORTHERN DIVISION.

UNITED STATES OF AMERICA,	}	Bond on Appeal.
<i>Libelant,</i>		
vs.		
STEAM TUG PILOT, Her Steam En- gines, Boilers, Machinery, Tackle, Apparel, Furniture, etc.,	}	
<i>Respondent,</i>		
And JOAN OLIVE DUNSMUIR, <i>Claimant.</i>		

Know all men by these presents, that we, Joan Olive Dunsmuir, as principal, and J. W. George and Robert Croft, of Seattle, in the County of King and State of Washington, as sureties are held and firmly bound unto the United States of America in the sum of fifteen hundred dollars (\$1,500), lawful money of the United States for which payment well and truly to be made we bind ourselves, our heirs, executors and administrators, firmly by these presents.

Sealed with our seals and dated this 28th day of December, A. D. 1891.

Whereas Joan Olive Dunsmuir, claimant, has lately appealed to the Circuit Court of Appeals for the Ninth Circuit from the decree of the Hon., the Judge of the District Court of the United States, in and for the District of Washington, made and pronounced in a certain action to recover a fine or penalty for the alleged violation of a certain statute of the United States, to-wit: section 4370 of the Revised Stat-

utes of the United States, said action being lately pending between said libelant and said claimant ;

Now, if said appellant shall well and truly abide by and fulfill and perform the judgment and decree of said Circuit Court of Appeals in the premises, and shall pay and satisfy said decree and such costs and charges as shall be ordered and adjudged to be paid on her part, then this obligation shall be void, otherwise to be and remain in full force and virtue.

JOAN OLIVE DUNSMUIR.

By BURKE, SHEPARD & WOODS,

*Her Attorneys.*

J. W. GEORGE, [SEAL]

ROBT. CROFT. [SEAL]

Sealed and delivered in presence of

ANDREW WOODS,

F. S. GRIFFITH.

Taken and subscribed before me this 28th of December,  
A. D. 1891.

F. S. GRIFFITH,

*Notary Public in and for the State of  
Washington, residence, Seattle.*

[SEAL]

DISTRICT OF WASHINGTON, }  
COUNTY OF KING. } ss.

J. W. George and Robt. Croft, of Seattle, in the County of King and State of Washington, sureties named in the foregoing bond, being each severally sworn, each for himself deposes and says: That he is a resident of and freeholder in the District of Washington, and is worth the sum of fifteen

hundred dollars (\$1,500) over and above all liabilities and property exempt from execution.

[SEAL]

J. W. GEORGE.  
ROBT. CROFT.

Subscribed and sworn to before me this 28th day of December, 1891.

F. S. GRIFFITH,  
*Notary Public in and for the State of  
Washington, residence, Seattle.*

And on the back of the foregoing is endorsed the words and figures following:

The within bond is hereby approved both as to form and the sufficiency of the sureties.

Seattle, Washington, December 31, 1891.

C. H. HANFORD,  
*Judge of the United States District Court  
for the District of Washington.*

Examination and justification of sureties herein is hereby waived and the within bond is accepted as sufficient both as to form and sufficiency of sureties.

Seattle, Washington, December 31, 1891.

P. H. WINSTON,  
*U. S. District Attorney.*

By P. C. SULLIVAN,  
*Assistant U. S. District Attorney.*

DISTRICT COURT OF THE UNITED STATES, DISTRICT OF WASHINGTON, NORTHERN DIVISION.

THE UNITED STATES OF AMERICA,	}	No. 259.		
vs.				
THE STEAM TUG PILOT, Her Steam Engines, Etc., and			}	Bond on Appeal.
JOAN OLIVE DUNSMUIR, <i>Claimant.</i>				

BURKE, SHEPARD & WOODS,  
*Proctors for Claimant.*

Service of the within paper on the undersigned; the 31st day of Dec., 1891, is hereby admitted.

P. C. SULLIVAN,  
*Assistant U. S. District Attorney.*

Filed this Dec. 31, 1891.

R. M. HOPKINS,  
*Clerk.*

CITATION.

*The United States of America to Patrick Henry Winston, Esq.,  
U. S. District Attorney: Greeting:*

You are hereby cited and admonished to be and appear at the Circuit Court of Appeals for the Ninth Circuit, to be held at San Francisco on January 29, 1892, pursuant to an

appeal filed in the Clerk's office of the District Court of the United States for the District of Washington, Northern Division, wherein the steam tug Pilot and Joan Olive Dunsmuir, owner of said steam tug Pilot, are appellants, and the United States is appellee, to show cause, if any there be, why the decree rendered against the said appellants as in said appeal mentioned should not be corrected, and why speedy justice should not be done to the parties in that behalf.

Witness my hand at Seattle, in the District of Washington, this 31st day of December, in the year of our Lord one thousand eight hundred and ninety-one.

C. H. HANFORD,  
*Judge of the United States District Court  
 for the District of Washington.* \*

And on the back of the foregoing is endorsed the words and figures following:

DISTRICT COURT OF THE UNITED STATES, DISTRICT OF WASHINGTON, NORTHERN DIVISION.

UNITED STATES OF AMERICA,	}	No. 259. Citation.
vs.		
STEAM TUG PILOT and JOAN OLIVE DUNSMUIR.		

BURKE, SHEPARD & WOOD,  
*Proctors for Claimant.*



Service of within paper on the undersigned, this 31st day of December, 1891, is hereby admitted.

P. C. SULLIVAN,  
*Assistant U. S. District Attorney.*

Filed this Dec. 31, 1891.

R. M. HOPKINS,  
*Clerk.*

IN THE UNITED STATES DISTRICT COURT FOR THE DISTRICT OF  
WASHINGTON, NORTHERN DIVISION.

UNITED STATES OF AMERICA, }  
DISTRICT OF WASHINGTON, } ss.

I, R. M. Hopkins, Clerk of the United States District Court, District of Washington, do hereby certify that the foregoing, numbering from pages 2 to 73, inclusive, is a true and perfect copy of the record of the above entitled District Court in the case of

THE UNITED STATES OF AMERICA,	}	No. 259. Admiralty.
<i>Libelant,</i>		
vs.		
STEAM TUG PILOT, Her Steamers, Engines, Boilers, Machinery, Tackle, Apparel, Furniture, Etc.,		
<i>Respondent</i>		
And JOAN OLIVE DUNSMUIR,	}	
<i>Claimant.</i>		

On appeal from the said above entitled District Court, to the United States Circuit Court of Appeals for the Ninth Circuit.

In witness whereof I have hereunto  
set my hand and the seal of  
said District Court this 12th day  
of January, 1892.

-----  
*Clerk.*

# INDEX.

---

	PAGES.
Answer,—Amended	9 to 12
Assignment of Error	66 to 67
Bond on Appeal	68 to 71
Claimant's Plea	7 to 8
Citation	71 to 73
Clerk's Certificate	74
Decree,—Interlocutory	58 to 59
Decree,—Final	60 to 61
Exceptions,—Claimant's	62 to 63
Findings of Fact	55 to 58
Libel of Information	2 to 4
Monition and Marshal's Return	5 to 7
Notice of Appeal	64 to 65
Opinion	53 to 55
Testimony	13 to 52



No 30

UNITED STATES  
CIRCUIT COURT OF APPEALS  
FOR THE  
NINTH CIRCUIT

APRIL TERM, 1892

THE UNITED STATES OF AMERICA,

*Appellee,*

vs.

THE STEAM TUG "PILOT," Her Steam En-  
gines, Boilers, Machinery, Tackle, Apparel,  
Furniture, Etc.,

and

JOAN OLIVE DUNSMUIR,

*Appellant.*

BRIEF OF APPELLANT

BURKE, SHEPARD & WOODS,

*Proctors for Appellant.*



UNITED STATES  
CIRCUIT COURT OF APPEALS  
FOR THE  
NINTH CIRCUIT

APRIL TERM, 1892

THE UNITED STATES OF AMERICA,  
*Appellee,*

vs.

THE STEAM TUG "PILOT," Her Steam En-  
gines, Boilers, Machinery, Tackle, Apparel,  
Furniture, Etc.,

and

JOAN OLIVE DUNSMUIR,  
*Appellant.*

BRIEF OF APPELLANT

BURKE, SHEPARD & WOODS,

*Proctors for Appellant.*

STATEMENT OF THE CASE.

---

On or about four o'clock p. m. on the 2nd day of May, 1891, the steam tug Pilot, being a British tug boat registered at Victoria in British Columbia, and owned by Joan Olive Dunsmuir, the claimant and appellant in this action, spoke, in the straits of San Juan De Fuca, the American bark Valley Forge, a vessel engaged in the coal trade between San Francisco, California, and Departure Bay, British Columbia, about ten miles inside the entrance of the straits and about three miles off Port San Juan on the island of Vancouver in the Province of British Columbia.

(Record, pages 17, 18, 36.)

Said bark Valley Forge was at this time bound to Departure Bay in British Columbia to load there with coal and the captain wished to be towed to Departure Bay by way of Port Angeles, and from Departure Bay back through the straits of San Juan De Fuca to the Pacific Ocean.

(Record, pages 18, 19, 37, 38.)

Accordingly, the captain of the steam tug Pilot agreed with the captain of the Valley Forge to tow the latter from the point of meeting, about three miles off Port San Juan on the coast of Vancouver's Island in British Columbia, to Departure Bay by way of Port Angeles, and from Departure Bay back through the straits of San Juan De Fuca to the Pacific Ocean.

(Record, pages 18, 19, 37.)

At the point where the steam tug Pilot picked up the



bark Valley Forge the straits of San Juan De Fuca are twelve miles wide, half of that distance being in American waters and half in British waters.

(Record, page 18.)

All of this distance within six miles from Port San Juan would be British waters. After picking up the bark Valley Forge the tug Pilot towed the Valley Forge along the Vancouver shore, and wholly within British waters, to Race Rocks on the Vancouver shore, a distance of 38 or 40 miles. This course was taken in order to take advantage of the tide and to make the quickest time.

(Record, pages 31, 37 and 46.)

From Race Rocks the Pilot crossed with the Valley Forge to Port Angeles in the State of Washington, which lies nearly opposite, south of Race Rocks and upon the straits of San Juan De Fuca, where she arrived on the morning of the 3rd of May, 1891. The greater part of the towing over this entire distance from the point of meeting, about three miles off Port San Juan, to the port of Port Angeles, was within and upon foreign waters, being north of the middle line of the channel of the straits of San Juan De Fuca, which separates the State of Washington from Vancouver's Island. After the Valley Forge arrived at Port Angeles, the captain was unable to continue immediately to Departure Bay, and the tug Pilot thereupon cleared from the port of Port Angeles on the 3rd day of May, 1891, with the understanding between the captain of the Valley Forge

and the captain of the tug Pilot, that the latter, after towing another vessel from Departure Bay to sea, should call at Port Angeles on her return and complete the contract of towing to Departure Bay, as agreed upon by the two captains. On the 6th day of May, 1891, the tug Pilot returned to Port Angeles for the purpose of completing the towing in accordance with the contract made with the captain of the bark Valley Forge (Record, page 22), when the collector of the port of Port Angeles seized and retained the tug Pilot for fourteen days. The tug was afterwards libelled by the United States of America, and the towing and the acts aforesaid are the towing and acts referred to and complained of in the libel in this action as being in violation of Section 4370 of the Revised Statutes of the United States.

The Valley Forge was engaged in trade between San Francisco and Departure Bay, and had been towed by the tug Pilot from the sea to Departure Bay and from Departure Bay to the sea, both before and after the seizure hereinbefore described. After the seizure and detention of the tug Pilot at Port Angeles, another British tug boat named the "Lorne," came to Port Angeles, towed the Valley Forge from Port Angeles into Departure Bay, and subsequently, after being released from the custody of the collector at Port Angeles, the captain of the tug Pilot completed his contract by towing the Valley Forge from Departure Bay to the sea.

(Record, pages 22 and 38.)

SPECIFICATION OF ERRORS.

First: The court below, the District Court of the United States for the District of Washington, erred in finding as a fact, "That on May 3, 1891, said bark Valley Forge was bound on a voyage from San Francisco, California, to Port Angeles in the State of Washington," instead of finding as a fact, and as the evidence in the case shows, that the bark Valley Forge was actually engaged in the coal trade between San Francisco, California, and Departure Bay in British Columbia, and was on May 3, 1891, actually and in fact bound on a voyage from San Francisco, California, to Departure Bay in British Columbia, for the purpose of loading there with coal. (Record, Pages 27, 29, 33, 34, 37, 39, 41 and 45.)

Second: The court erred in finding as a fact that the tug Pilot towed the bark Valley Forge from the point of meeting, to-wit, three miles off the shore of Vancouver's Island, near Port San Juan, across the strait to Port Angeles, instead of finding as a fact, and as the evidence shows, that the tug Pilot towed the bark Valley Forge from the point of meeting, about three miles off Port San Juan, for 38 or 40 miles along the shore of Vancouver's Island to Race Rocks, and thence across the straits of San Juan De Fuca to Port Angeles, a contract having been made at the time with the master of said bark Valley Forge that she should be towed by said tug Pilot, first to Port Angeles, thence to Departure Bay in British Columbia and there to load and thence again to sea. (Record, Pages 31, 37 and 46.)

Third: Said court erred in finding as a fact, "That said tug Pilot, by reason of towing said bark Valley Forge as aforesaid, became liable to the penalty of \$643," levied upon her at the time of the seizure, inasmuch as the towing described in the libel in this action was within the exception of Section 4370 of the Revised Statutes, to-wit: "This Section shall not apply to any case where the towing, in whole or in part, is within or upon foreign waters."

Fourth: Said court erred in entering the decree of November 24, 1891, "That the United States do have and recover of and from said claimant Joan Olive Dunsmuir on said bond, the sum of \$643, with costs of libellant" as the steam tug Pilot herein was not subject to the penalty provided in case of a violation of Section 4370 of the Revised Statutes of the United States, but was within the exception therein stated, the towing having taken place in part in foreign waters, and the whole of the towing having been in waters where the tug Pilot had a right to be, and where navigation for it and the vessel it had in tow was free and open.

Fifth: Said court erred in entering the decree of December 18, 1891, "That the United States do have and recover of and from Joan Olive Dunsmuir, the principal in said bond named, and R. Lea Barnes and Robert Croft, sureties on said bond of the claimant herein, the sum of \$643, together with costs of the libellant herein," as the tug Pilot was not subject to the penalty provided in case of a violation of Section 4370 of the Revised Statutes of the United States, but was within the exception therein stated, the

towing having taken place in part in foreign waters, and the whole of the towing having been in waters where the tug Pilot had a right to be, and where navigation for it and the vessel it had in tow was free and open.

Sixth: Said court erred in not dismissing the libel herein.

Section 4370 of the Revised Statutes, or so much of it as is necessary for the decision of this case, is as follows :

“Sec. 4370. All steam tug boats not of the United States found employed in towing documented vessels of the United States plying from one port or place in the same to another, shall be liable to a penalty of fifty cents per ton on the measurement of every such vessel so towed by them respectively which sum may be recovered by way or libel or suit. This section shall not apply to any case where the towing in whole or in part is within or upon foreign waters \* \* \* \* ” (Act further to prevent smuggling and for other purposes, July 18, 1866.)

Article I of the Treaty between Great Britain and the United States in regard to limits westward of the Rocky Mountains, signed on the 15th day of June, 1846, is as follows :

“From the point on the forty-ninth parallel of north latitude, where the boundary laid down in existing treaties and conventions between the United States and Great Britain terminates, the line of boundary between the ter-

ritories of the United States and those of her Britannic Majesty shall be continued westward along the said forty ninth parallel of north latitude to the middle of the channel which separates the continent from Vancouver's Island, and thence southerly through the middle of the said channel, and of Fuca's Straits, to the Pacific Ocean : *Provided, however,* That the navigation of the whole of the said channel and straits, south of the forty-ninth parallel of north latitude, remain free and open to both parties.

## POINTS.

### I.

By reference to pages 27, 29, 33, 34, 37, 39, 41 and 45 of the record, it will be seen that the actual destination of the bark Valley Forge was not to Port Angeles, but to Departure Bay in British Columbia. The testimony of Captain John J. Bennett, the Captain of the Valley Forge, was that the captain of the tug Pilot "came up along side and asked me where I was bound to and whether I wanted a tug ; I told him I was bound to Nanaimo to load with coal," and a contract was then made to tow the Valley Forge to Nanaimo, situated upon Departure Bay, by way of Port Angeles, and after the Valley Forge had loaded with coal at Nanaimo to tow her back to sea. (Record, p. 37). The Valley Forge neither loaded nor unloaded anything at Port Angeles, nor did her captain intend either to load or unload there

but she was actually in ballast and bound for Nanaimo at the time that she left San Francisco.

Knowing that the Valley Forge was engaged in the coal trade between Nanaimo and San Francisco, the captain of the tug Pilot, at the time and place of meeting, took the Valley Forge in tow for a foreign port, to-wit, Nanaimo, upon Departure Bay, and not for an American port, under an express contract of towing as above stated. (Record, pp. 27, 29, 37, 39 and 45). After the seizure of the tug Pilot the Valley Forge actually went to Nanaimo in British Columbia, loaded there with coal, and cleared for San Francisco, in accordance with her custom. (Record, pp. 33, 34, 42 and 45). The facts being as indicated in the record, it is respectfully submitted that the finding of fact that the bark Valley Forge was bound on a voyage from San Francisco, California, to Port Angeles in the State of Washington was erroneous, and that the judge of the District Court should have found as a fact that the actual destination and voyage of the bark was as the evidence shows it to be.

If, therefore, the actual destination of the bark was to a foreign port the towing was in all respects lawful, and not at all within the terms of Section 4370 of the Revised Statutes of the United States. If the captain of the Valley Forge was seeking to evade the law by not clearing for the port of his actual destination, the captain of the tug Pilot should not be held responsible for the acts of the former, and should not have been prevented from completing the towing into a foreign port, even though

it was *through* the waters of Port Angeles under the terms of his contract. The towing was to have been one continuous act from the point of meeting, about three miles off Port San Juan, to Departure Bay in British Columbia, thence back to sea. The voyage of the Valley Forge really began at San Francisco, was not finished until she reached Nanaimo upon Departure Bay in British Columbia, and had there obtained what she was to load with. The mere calling at Port Angeles did not bring her within the statute or make the tug Pilot liable for a penalty under Section 4370 of the Revised Statutes, especially as the captain of the Valley Forge may have been evading some other statute which the captain of the Pilot knew nothing of and which did not in any way concern him.

## II.

The towing of the bark Valley Forge actually and necessarily began in foreign waters, about three miles off Port San Juan, and, on account of the condition of the tide, necessarily and in fact continued for forty miles in foreign waters. (Record, p. 46). It may be contended that the Valley Forge tacked across the middle of the channel of the Straits of San de Fuca for the purpose of being picked up by a British tug. This contention, however, is not supported by the evidence (Record, p. 40), as the bark had merely tacked across the middle of the channel to catch the wind, and as the captain of the Valley Forge testified that he had employed both British and American tugs to tow him into Nanaimo. He employed, as he says (Record, p. 48), "whichever came handiest," and



whichever tug he could make the best bargain with, as he actually testified at the trial, but which the reporter failed to take. (Record, p. 48). There was therefore no attempt or intention to evade Section 4370 of the Revised Statutes, and no fraud committed or attempt to be committed and, inasmuch as he was bound to a British port, to-wit, Nanaimo, he would naturally employ a British tug to do the towing, and especially as he knew that a law similar to Section 4370 prevailed in the British dominions. It seems, therefore, that the judge of the District Court erred in finding as a fact that the tug Pilot towed the bark Valley Forge from the point of meeting across the Straits to Port Angeles, when the evidence and all the facts therein showed that the towing began and continued for forty miles in foreign waters, and was a greater part of it in foreign waters. (Record, pp. 31, 37 and 46).

### III.

By the treaty with Great Britain of June 15, 1846, it will be seen that the boundary line between the British possessions in British Columbia and those of the United States is clearly defined, and that this boundary line after leaving the forty-ninth parallel of north latitude runs to the middle of the channel which separates the continent from Vancouver's Island, and thence southerly through the middle of said channel and Fuca's Straits to the Pacific Ocean. Therefore, all north of the middle of Fuca's Straits would be under the government and control of Great Britain, and hence foreign waters; and

all south of the middle of the channel would be under the government and control of the United States and hence domestic waters.

The purpose of the two countries is even more clearly expressed in their action subsequent to the award of the Emperor of Germany, dated October 21, 1872, that, "The boundary line between the Territories of Her Britannic Majesty and the United States should be drawn through the Haro Channel." On the 21st day of November, 1872, Sir Edward Thornton, in a note to Mr. Fish, said: "Earl Granville has further instructed me to propose to the Government of the United States that the work of the boundary commission, which was interrupted in 1859 should be resumed and completed by the preparation of a map or chart showing the exact position of the boundary line from the Gulf of Georgia through the Haro Channel to the Ocean, under the treaty of 1846, and the award of the Emperor of Germany." And thereupon, on the 10th day of March, 1873, Mr. Fish, in behalf of this government, and Sir Edward Thornton and Rear Admiral James Charles Prevost, in behalf of Her Britannic Majesty, signed a protocol specifically defining the exact boundary line between the two countries, through the straits in question to the Pacific Ocean, and tracing the same upon certain charts therein referred to. By treaty and by the acts of the two countries they have assumed and claimed the entire waters of the Straits of San Juan de Fuca as territorial and Mr. W. E. Hall in his work on international law, at page 140, cites this very case as one where the two nations have

divided the entire waters and assumed control of the same.

The opinion of the judge of the district court who decided this case concedes that the waters lying north of the middle of Fuca's Straits are foreign waters; for, in his opinion, he says: "By treaty stipulations the boundary between the two countries is upon a line following the middle of the strait, and all that part of it north of the middle is British water and all south of the line is American water." He concedes at the very beginning that a large part of the waters wherein the towing occurred are British waters, and therefore, it is respectfully submitted, he concedes that they are foreign waters. He continues in his opinion as follows: "But by the treaty the entire strait is free and open to both countries for purposes of navigation, so that the vessels of each are free to sail anywhere in the strait upon either side of the line." The conclusion that the judge of the district court draws from this treaty seems to us erroneous, when he states that no part of the straits can be regarded as foreign waters to either American or British vessels. These waters on either side of the middle line of the straits must, under the terms of the treaty, be under the government and control of the nations respectively named in the treaty. The waters north of the middle line are foreign waters to the United States of America, and the waters south of the middle line are foreign waters to Great Britain. Each nation, however, has given to the other the privilege of passing and repassing over the waters of the other for the purposes of navigation.

This privilege, it is respectfully submitted, is in the nature of a license, or, perhaps, of an easement, granted by the one nation to the other for the benefit of trade and navigation.

When we consider these waters with reference to Section 4370 alone, inasmuch as the distinction that is there drawn must necessarily be between foreign and domestic waters, the true construction of the treaty seems to us to be that all the waters of the Straits of Fuca that lie north of the middle of the channel must be designated as foreign waters, and all of the waters of the Straits of Fuca that lie south of the middle of the channel must be designated as domestic waters; and in construing the meaning of this statute, no such term as "common" waters could have been contemplated by the framers of the statute. For, if the waters of the Straits of Fuca can be called "common" waters in construing Section 4370 of the statute, then the waters along the northern boundary of the United States, between the States and Canada, and also the waters on the southern boundary between the United States and Mexico, must all be called *common* and the word *foreign* can mean nothing in the proviso in the statute, because, if the judge of the district court be correct, none of these waters are under the exclusive dominion of a foreign government for all purposes, and therefore are not foreign waters. Yet it is obvious that the statute was framed to meet cases of towing on these very waters and the word foreign waters as used in the proviso of Section 4370 must mean all waters lying on the other side of the dividing line

which separates the dominions of the United States and other nations, i. e., all waters which are not domestic waters and subject to the control of the home government.

If the judge of the district court is correct in his definition of foreign waters, then there would be no force in the exception in Section 4370 and no reason in making it the subject of an amendment as was done by Congress, (Feb. 25, 1867).

The word "foreign" is defined in Bouvier's Law Dictionary as that which belongs to another country, and in Rapalje & Lawrence's Law Dictionary as that which is out of a certain state, country, county, liberty, manor, jurisdiction, etc. Thus, in the law of divorce, "foreign" means anywhere out of the country or state.

An examination of the treaties with Great Britain which settled the boundary between the United States and the British possessions will show, as we think, the correctness of our contention.

By Article II of the Definitive Treaty with Great Britain of September 3, 1783, and by subsequent treaties the boundaries between the United States and the British possessions were fixed and wherever a river or lake was made the boundary between the possessions of the two nations, the middle of the river or lake was made the dividing line between the possessions of the respective nations. By Article III of the same treaty, the navigation of the river Mississippi from its source to the ocean was forever to remain free and open to the

subjects of Great Britain and the citizens of the United States.

By Article III of the treaty with Great Britain of 1794 it was "agreed that it at shall at all times be free to His Majesty's subjects, and to the citizens of the United States, and also to the Indians dwelling on either side of the boundary line, freely to pass and repass by land or inland navigation, into the respective territories and countries of the two parties, on the continent of America (the country within the limits of the Hudson's Bay Company only excepted) and to navigate all the lakes, rivers and waters thereof, and freely to carry on trade and commerce with each other. But it is understood that this article does not extend to the admission of vessels of the United States into the seaports, harbors, bays, or creeks of His Majesty's said territories; nor into such parts of the rivers in His Majesty's said territories as are between the mouth thereof, and the highest port of entry from the sea, except in small vessels trading *bona fide* between Montreal and Quebec, under such regulations as shall be established to prevent the possibility of any fraud in this respect. Nor to the admission of British vessels from the sea into the rivers of the United States, beyond the highest ports of entry for foreign vessels from the sea. The river Mississippi shall, however, according to the treaty of peace, be entirely open to both parties; and it is further agreed, that all the ports and places on its eastern side, to whichsoever of the parties belonging, may freely be resorted to and used by both parties, in as ample a manner as any

of the Atlantic ports or places of the United States, or any of the ports or places of His Majesty in Great Britain.”

By Article II of the treaty with Great Britain of August 7, 1842, the boundaries between the territories of the United States and the possessions of her Britannic Majesty in North America were defined, and the last sentence of Article II is as follows: “It being understood that all water communications and all usual portages along the line of Lake Superior to the Lake of the Woods and also Grand Portage, from the shore of Lake Superior to the Pigeon River, as now actually used, shall be free and open to the use of the citizens and subjects of both countries.”

By Article III of the same treaty it is provided that “In order to promote the interests and encourage the industries of all the inhabitants of the countries watered by the river St. John and its tributaries, whether living within the State of Maine or in the Province of New Brunswick, it is agreed that where, by the provisions of the present treaty, the river St. John is declared to be the line of boundary, the navigation of the said river shall be free and open to both parties, and shall in no way be obstructed by either.”

Section 4370 of the Revised Statutes was passed to regulate towing between the vessels of Great Britain and the United States, especially upon the Great Lakes. After the passage of the act, in 1866, a petition was presented to Congress by persons engaged in commerce upon the lakes asking that a proviso be adopted similar to the proviso

which was afterwards actually adopted on February 25, 1867. This proviso was made to remove the burden and hardship which the law of 1866 had imposed upon foreign tugs engaged in towing upon the lakes.

See Congressional Globe, 38th and 39th Sessions of Congress.

In considering and construing Section 4370, which is a penal statute, we contend, therefore, that there can be no such thing as common waters, but that the waters on each side of the boundary line between the United States and a foreign nation must be either foreign or domestic waters, and that whenever the towing is in whole or in part beyond the boundary line of the United States of America it is within foreign waters, within the exception of Section 4370, and is not a violation of Section 4370 of the Revised Statutes. The definition of the term "foreign waters," as waters under the *exclusive* dominion of a foreign government *for all purposes*, is a strict, rigid and erroneous definition. If this definition be correct, it might, with equal force, be argued that the soil of Mexico (Treaty with Mexico, December 30, 1853, Article VIII), or of some of the states of Europe which have treaties or agreements wherein they have granted to other nations the right to transport men and munitions of war across their territory in case of war, were not states foreign to the nations with which they have made such treaties or agreements, and that their soil was not foreign soil; because, as the learned judge would contend, they do not have *exclusive* dominion over their soil for *all* purposes. As it seems to us, however, the soil of the state that makes



a treaty or agreement as referred to is foreign soil, as far as the nation with which it makes the treaty or agreement is concerned, and that the soil is under the exclusive dominion of the state making the treaty or agreement, although it may, by mere license, or, perhaps, by an easement, give another nation the right to cross its dominion for certain purposes. In international law, we think that there can be no question that the soil of a state making such a treaty or agreement would be regarded as foreign soil. In the same way, as it seems to us, there can be no question that a foreign nation which merely allows to another nation the privilege of crossing and recrossing its waters is not deprived thereby of dominion over the waters within its boundary lines, and that its waters are still foreign waters to the nation possessing the privilege, notwithstanding the existence and continuance of the privilege. So the waters of the Straits of San Juan De Fuca north of the middle of the channel, are foreign waters, subject only to the license or easement granted to American vessels to sail upon them without interference. Inasmuch, therefore, as the towing in this case began in British waters and the larger part thereof was in British waters, and hence, as the appellant contends, in foreign waters, it is respectfully submitted that the facts in this case do not show any violation of Section 4370 of the Revised Statutes, and that this section does not apply to the acts complained of, the towing being in part within and upon foreign waters.

#### IV.

The towing into Port Angeles was only a small part of

the entire distance over which the bark Valley Forge was to be towed. The entire contract of towing was from the point of meeting, about three miles off Port San Juan, to Departure Bay by way of Port Angeles, and from Departure Bay to sea. The destination of the Valley Forge being Departure Bay, the most of the towing, had the Pilot been allowed to continue and perform her contract, would have been, and actually was in British, and hence foreign waters, and clearly within the exception pointed out by the statute. Had not the towing been prevented by the captain of the Valley Forge, it would have been a continuous towing from the point of meeting, about three miles off Port San Juan, in British waters, thence to Port Angeles, thence to Departure Bay, and from Departure Bay to the sea. There was in this case, no evasion or attempt at evasion, of Section 4370 of the Revised Statutes of the United States by the captain of the Pilot, and no fraud was committed or intended to be committed in the matter by him. The acts done by him had been done by him before, and were justified by the exception in the statute, which seems clearly to meet a case of towing like the case in question. It might almost be said that the exception (which was the subject of an act amending the original act by which the statute became law) was framed to meet and provide for such a case as this in question. If this case in question is a violation of the statute, and is not within the exception, then a strict, rigid and unreasonable construction of this statute must be adopted as the true construction; and in order to be within the exception provided for in the statute, it would be absolutely necessary

that the towing by a foreign tug should actually be from a foreign port in order to bring the towing under the exception which provides that the towing may be in part within or upon foreign waters. No such rigid construction of the statute could have been contemplated by the framers thereof, and any such construction is contrary to the spirit of the amendment to the original act. Had such been the intention of the statute, it would have been as easy to say that the towing must be wholly in foreign waters, or when in part in foreign waters must be from a foreign port, which is both unjust and unreasonable.

Moreover this cannot be the construction of the exception provided in the statute for the statute applies only to “documented vessels of the United States plying from one port or place in the same to another” and any towing from a foreign port to a port in the United States or from a port in the United States to a foreign port is entirely outside and independent of the statute.

It is contended for the appellee that the exception applies only where the towing is *necessarily* within or upon *foreign* waters, and yet where the vessel is a “vessel of the United States plying from a port or place in the same to another,” it will be difficult, if not impossible, to name a place along our entire boundary or an example, where the exception can apply, provided the contention of the appellee is correct.

The present case furnishes as good an example as can be thought of where the exception can apply. The towing in this case begins in foreign waters, even within a

marine league from the shore, continues for forty miles in foreign waters and, but for the seizure of the Pilot, would have ended in a foreign port or upon the sea.

If the towing must necessarily be in foreign waters to bring it within the exception, the exception cannot apply to navigation by American vessels upon the Great Lakes (unless in a case similar to this case), because the boundary line between the possessions of the two countries being in the middle of the lakes and rivers, it will be difficult to find any lake or river where the towing could not be done on the American side of the boundary line and the exception would have little, if any, force.

## V.

Port Angeles is situated on the Straits of San Juan de Fuca, nearly opposite Race Rocks and directly across the Straits of San Juan de Fuca from Vancouver's Island. Every part of the Straits of San Juan de Fuca must, under the treaty of 1846 with Great Britain, be free and open for navigation to the vessels of both Great Britain and the United States. If such is the case—and the language of Article I of the Treaty it seems to us cannot be questioned—then the vessels of each nation are free to sail anywhere, with whatever they may have in tow, in these straits, upon either side of the middle of the channel, and into every port situated upon these straits. This being the case, Section 4370 must, as it seems to us, be considered as suspended, so far as any place upon these straits is concerned, and navigation in these straits being free and open, a towing from the high seas or from

any point in foreign waters into a port upon these straits is not within the statute and hence not a violation of the same. Much less can this statute apply to a towing which, if uninterrupted, would have been only *through* the waters of Port Angeles and *through* and upon waters which have been declared by treaty to be free and open to navigation for vessels of both nations. If such is not the case, then the navigation of the Straits of San Juan de Fuca is restricted, and not free and open in accordance with the treaty. If the construction of the statute and the decision of the judge of the district court in this case be correct, the navigation of the Straits of Fuca is not free and open, and has at least one restriction upon it, to-wit: that which the learned judge has endeavored to impose by his decision under Section 4370 of the Revised Statutes. If the navigation of the Straits of San Juan de Fuca, and every part thereof, is free and open, a foreign tug can tow an American vessel from the high seas or from any point in foreign waters into any port upon these straits, and into any part of these straits or into any harbor, bay or inlet leading to the straits, without hindrance or interference. Much more, then, can a foreign tug tow an American vessel from foreign waters *through* a port in these straits and thence to a foreign port, as the tug Pilot would have done in this case if not prevented, and which actually was done by another foreign tug in completing this same towing to Departure Bay. It must be borne in mind that the towing in this case began in foreign waters, at a point within a few miles of a foreign shore; that the towing not only began

but was to terminate in a foreign port, and after the loading of the vessel was to end upon the high seas. This towing was made by way of an American port, which, by treaty between Great Britain and the United States of America, was situated upon waters which are free and open for navigation to British vessels, and the acts complained of are within the privilege conferred by the United States upon Great Britain when the former allowed to the vessels of the latter free navigation of every part of the Straits San Juan de Fuca. If, therefore, the treaty between Great Britain and the United States is still in force—and we know of nothing to the contrary—then the acts complained of, being in the exercise of a lawful right and within the express grant of the United States, cannot be a violation of Section 4370 of the Revised Statutes.

## VI.

All regulations respecting navigation should not be inconsistent with any treaty now existing and still in force between Great Britain and the United States. To hold that the towing in this case, which began in foreign waters, continued mostly within foreign waters, and was to end in foreign waters, is a violation of Section 4370 of the Revised Statutes and not within the exception therein provided, is clearly a regulation inconsistent with the proviso in Article I of the treaty between Great Britain and the United States dated June 15, 1846. But the statute can be construed so that there would be no inconsistency between it and the treaty of 1846, for

the language of the statute is plain and clear, that when the towing is in whole or in part in foreign waters there is no violation of the statute, and it is only by adopting a forced and erroneous definition of the word "foreign" that any difficulty is encountered. The statute should be examined as a whole and if this and the treaty can be reconciled by a reasonable construction of each, this should be done. It is the duty of the court to administer the laws as it finds them and as they exist without straining them to reach apparent but not real evasions and mischiefs that they are not designed to remedy. If the towing in this case is in part in foreign waters it is clearly within the exceptions of the statute and the claimant is not liable for any penalty. The question whether the captain of the tug Pilot intended and designed to evade the statute must be decided by the evidence in this record and not by mere general suspicions. There is no proof that there was any intention on the part of the captain of the tug Pilot to evade the statute or to commit a fraud. On the contrary, the whole evidence shows that he was acting honestly and doing what he honestly believed he had a right to do, and what both the statute itself and the treaty of 1846 gave him, as the appellant contends, the right to do. He was doing what he and other captains, both British and American, had done before under similar circumstances, believing that they had not only a right, but express permission under the government of each nation, respectively, to do. The captain of the tug Pilot knew nothing about the papers of the Valley Forge (Record page 45), but he did know

that the latter had been, and was at that time, engaged in the coal trade between Departure Bay and San Francisco. This court, therefore, can only consider the question whether this statute has been violated, and if it has not, then the claimant is not liable for the penalty imposed and the libel should be dismissed.

## VII.

A foreign tug can come into an American port and tow a vessel from it into a foreign port, and this is not within the statute. There is no difference between this case and that of a foreign tug towing an American vessel from any point in foreign waters into an American port. For example, we will suppose that an American documented vessel plying between Sitka in Alaska and Seattle in Washington voluntarily or involuntarily comes into the port of Victoria, British Columbia, and there engages a British tug to tow her to Port Angeles. There can be no question that such towing is not within the statute at all, or if it is within the statute then the proviso of Section 4370 of the Revised Statutes must apply, and if a British tug should tow such a vessel from Victoria into Port Angeles, the tug would not be liable to any penalty under the statute. But let us suppose that the towing of the American vessel plying between the same points begins a mile outside of the port of Victoria, in British waters, however, and continues to the port of Port Angeles. The cases, as it seems to us, are parallel cases; the towing in each case begins in, and is in part within foreign waters. If, how-



ever, the decision of the District Court be correct, the latter case would not be within the exemption of the statute and the British tug would be liable to a penalty under the statute. This, as it seems to us, is not a fair or reasonable construction of the statute. It is an attempt to stretch the statute to meet a case that is clearly within the exception to the statute, and an attempt to find a remedy for a mischief, whether real or imaginary, that the statute was not designed to remedy.

### VIII.

As Section 4370 of the Revised Statutes is a penal statute, it must be construed strictly and should not be so construed as to create an offence where one does not clearly exist. Therefore, all waters that are not domestic waters and under the control of the United States should, in construing this statute, be considered as foreign waters. Even the high seas, *not* being domestic waters and under the control of the United States should, in the examination of the statute, and that too a penal statute, be regarded as *foreign* waters, for the high seas, so far as this statute is concerned, are foreign waters and any steam tug boat not of the United States has a right to tow an American documented vessel upon them. If, therefore, the towing began either on the high seas or at any point in foreign waters and continued in foreign waters, especially when, as in the case of the Pilot, it was also to end in foreign waters, the presumption is against any violation of the statute and all of the facts and a sound and reasonable view of the statute is against a

construction that would make the tug liable to the penalty, as claimed in the libel. The towing in this case was a *bona fide* necessary towing in foreign waters which began in foreign waters and but for seizure would have terminated in foreign waters, without any intention or purpose on the part of the captain of the Pilot to evade the law or commit a fraud.

IX.

In the case of the Amerian tug Mogul, referred to in the evidence (record, page 51), the records of the treasury department show that the tug was seized and fined some months ago by the Canadian customs authorities for having towed a vessel from a place in the Straits of Juan de Fuca more than three miles from the shore of British Columbia, but on the British side of the center of the strait, to a port in British Columbia. This was clearly a violation of the Canadian statute, being a towing which began, continued and ended wholly within Canadian waters. The facts in the case of the tug Pilot are entirely different and we think clearly within the exemption in the statute of each country.

X.

The acts complained of in the libel of the appellee herein are not in violation of Section 4370 of the Revised Statutes of the United States, and the libel should be dismissed with costs to the appellant.

*and the decree of Nov 24, 1891 and Dec 18, 1891 should be set aside*

BURKE, SHEPARD & WOODS,  
*Proctors for Joan Olive Dunsmuir, Appellant.*

No 30

UNITED STATES  
CIRCUIT COURT OF APPEALS  
FOR THE  
NINTH CIRCUIT.

OCTOBER TERM, 1891.

THE UNITED STATES of AMERICA,

*Appellee.*

VS.

THE STEAM TUG "PILOT," Her  
Engines, Boilers, Machinery, Tackle,  
Apparel, Furniture, Etc.,

*Respondent.*

JOAN OLIVE DUNSMUIR,

*Appellant,*

BRIEF OF APPELLEE.

PATRICK H. WINSTON,  
*U. S. Attorney, Counsel for Appellee.*



UNITED STATES  
CIRCUIT COURT OF APPEALS  
FOR THE  
NINTH CIRCUIT.

OCTOBER TERM, 1891.

THE UNITED STATES OF AMERICA.

*Appellee.*

vs.

THE STEAM TUG "PILOT," Her  
Engines, Boilers, Machinery, Tackle,  
Apparel, Furniture, Etc.,

*Respondent.*

JOAN OLIVE DUNSMUIR,

*Appellant.*

BRIEF OF APPELLEE.

## STATEMENT OF FACTS.

This is a case of seizure to enforce a penalty imposed by Section 4370, Rev. St., U. S.

The facts are as follows: On the 2nd day of May, 1891, the Valley Forge, a documented vessel of the United States, of 1286 tons burden, engaged in coastwise trade, being bound on a voyage from San Francisco, California to Port Angeles, Washington, entered the Strait of Juan de Fuca without assistance and was beating from one shore of said strait to the other against a head wind towards Port Angeles, her port of destination (See Record, pp. 39 and 40).

The Pilot, a British steam tug-boat, was "out seeking," and picked up the Valley Forge on the north side of the strait and within three miles of the shore of Vancouver Island, where she had sailed on her port tack, and towed her across the strait to Port Angeles. The Valley Forge remained at Port Angeles until her master went to the custom-house at Port Townsend and exchanged her certificate of enrollment for a register to entitle her to clear for a foreign port (See Record, pp. 36 and 37).

## STATEMENT OF LAW.

## I.

Section 4370 of the Revised Statutes reads as follows:

"SEC. 4370. All steam tug-boats not of the United States found employed in towing documented vessels of the United States plying from one port or place in the same to another, shall be liable to a penalty of fifty cents per ton on the measurement of every such vessel so towed by them respectively which sum may be recovered by way of libel or suit. This section shall not apply to any case where the towing in whole or in part is within or upon foreign waters."

The only question in this case is whether the towing of the "Valley Forge" by the Pilot was "in whole or in part

within or upon foreign waters," within the meaning of Section 4370.

The mere fact that a documented vessel of the United States, plying from one port in the United States to another in making a passage of the Strait of Juan de Fuca, tacks across the international boundary line, will not legalize a towage service which would be a violation of law if performed wholly on the American side of the line.

Admitting that part of the strait north of the middle to be foreign waters it is respectfully submitted that the exception contained in Section 4370 applies only where the towing is *necessarily* within or upon foreign waters. Otherwise the statute can be evaded by a vessel crossing the boundary line for the sole purpose of bringing the towing within the exception of the statute.

## II.

The term "foreign waters," as used in Section 4370, means waters *wholly* foreign—waters under the *exclusive* dominion of a foreign government for all purposes.

*United States vs. The Pilot, Federal Reporter, Vol. 48, p. 319.*

## III.

The waters of the Strait of Juan de Fuca are not foreign waters to American vessels.

This strait is an arm of the sea wholly within the jurisdiction of the United States and Great Britain as part of the territory of the two countries, and the vessels of both coun-

tries by treaty stipulations are free to sail anywhere in the strait upon either side of the boundary line.

*The Appollon*, 9 Wheaton, 362.

*United States vs. The Pilot*, Federal Reporter, Vol. 48,  
p. 319.

Article 1, Treaty of Washington, June 15, A. D. 1846, re-  
affirmed by Protocol March 10, A. D. 1873.

9th. ~~and~~ Vol. U. S., ~~Revised Statutes~~, ~~266~~ at Large 869

PATRICK H. WINSTON,  
U. S. Attorney, Counsel for Appellee.



*United States Circuit Court of Appeals, Ninth Circuit.*

---

UNITED STATES	}	No. 30.
vs.		Filed April 19th, 1892.
THE STEAM TUG "PILOT," ETC.		

---

*Appeal from the District Court of the United States, for the District of Washington, Northern Division.*

---

Libel by the United States against the British tug Pilot for violation of Sec. 4370, Revised Statutes. Decree for Libellant for \$643 and costs. The owner appeals. Reversed.

---

Thos. R. Shepard, for Appellant,  
P. H. Winston, for Appellee.

FOREIGN WATERS—TOWAGE BY FOREIGN TUG BOATS.—The treaty between the United States and Great Britain of June 15th, 1846, fixes the boundary between the two countries in the Straits of San Juan de Fuca by a line following the middle of the strait, but also secures to each nation a right of free navigation over all the waters of the strait, held, that all the waters north of the boundary line are "foreign waters" within the meaning of Rev. St., Sec. 4370, which excepts from the penalty therein imposed against foreign tug boats towing vessels of the United States, cases where the towing is in whole or in part within or upon foreign waters.

GILBERT, Circuit Judge :

On the second day of May, 1891, the British tug Pilot, spoke the American bark Valley Forge in the Straits of San Juan de Fuca at a point about ten miles from the entrance to the straits and three miles off Port Vancouver in the Province of British Columbia. The bark was an enrolled vessel engaged in coastwise trade and was proceeding on her voyage from San Francisco to Port Angeles. A contract was made between the captains of the two vessels by which it was agreed that the tug should tow the bark to Port Angeles, where the bark would exchange her certificate of enrollment for a register to entitle her to clear for a foreign port, and then should tow her to Departure Bay a British port, thence back through the straits to the sea.

After picking up the bark the tug towed her along the Vancouver shore, a distance of 38 or 40 miles and thence across the straits to Port Angeles. The greater part of the towing was upon waters north of the middle line of the channel which separates the State of Washington from Vancouver's Island. The bark lay at Port Angeles until the sixth day of May when the tug was libeled by the United States for violation of Sec. 4370 of the Revised Statutes.

That section contains the act of July 18, 1866, entitled "An act to prevent smuggling and for other purposes," and the amendment to the same by the Act of Feb. 25th, 1867.

It reads as follows:

"Sec. 4370: All steam tug boats not of the United States, found employed in towing documented vessels of the United States plying from one port or place in the same to another, shall be liable to a penalty of fifty cents per ton on the measurement of every such vessel so towed by them respectively which sum may be recovered by way of libel or suit. This section shall not apply to any case where the towing in whole or in part is within or upon foreign waters."

The question is presented whether the waters of the Straits of San Juan de Fuca lying north of the dividing line between the United States and British Columbia are foreign waters within the meaning of the statute.

By the treaty between the United States and Great Britain of June 15th, 1846, the boundary line between the possessions of the two nations is made to run through the middle of the straits. By the same treaty, however, it is stipulated that the entire strait shall be open and free to both countries for the purposes of navigation so that the vessels of each may sail anywhere upon either side of the line, and under this provision it is contended that the waters north of the line cannot be considered foreign waters, but that all the waters of the strait are common to both nations.

We do not so construe the effect of the treaty. Notwithstanding the license of free navigation over the whole of the straits which is reserved to each of the contracting parties, a definite line of division is adopted, which determines the limit of jurisdiction of each nation. All waters north of the line are British waters subject to the control and dominion of Great Britain. All waters south of the line are American waters and are under the jurisdiction of the United States. The privilege of free navigation exercised by each nation of

the waters of the other is in the nature of an easement which in no way affects the question of the jurisdiction.

The decree of the District Court which is appealed from is itself a declaration of the doctrine of the exclusive jurisdiction of each nation over its own half of the waters of the strait, otherwise it is not perceived that a British tug could, for an act committed upon the American side of the line, be made subject to a penalty imposed by the laws of the United States.

The word foreign means belonging to another nation or country, belonging to or subject to another jurisdiction. The waters of the strait north of the boundary line belong to and are subject to the jurisdiction of Great Britain and hence are foreign waters.

The United States, although having a right of free navigation, has no jurisdiction over them except so far as regards its own citizens.

The case of *The Appollon*, 9 Wheat. 362, is relied upon by the appellee as supporting the doctrine that no part of the waters of the strait can be considered foreign to either British or American vessels. The question which arose in that case was whether a French vessel which had entered and anchored in the St. Mary's river and then proceeded out to sea and to a Spanish port had entered American waters so as to be required to make entry at the custom house of that district under Section 29 of the Collections Act of 1799. The St. Mary's River being the boundary between the United States and the Spanish possessions, upon the general principles of the law of nations, its waters were common to both nations for the purposes of navigation. The Court, without deciding whether any of the waters of the river were American waters, held that the true exposition of the 29th Section was that it meant to compel an entry at the custom house of all vessels coming into our waters *being bound to our ports*, and that the *Appollon* had not entered American waters within the meaning of that Statute.

It is proper to note that the evident object of the amendment contained in Sec. 4370 of the Statute is in harmony with the construction which we have adopted. The law as originally enacted did not embody the exception in regard to towage in whole or in part upon foreign waters. Upon the petition of "owners of tugs and vessels on the lakes and rivers of the northern frontier," the amendment of Feb. 25, 1867, was made. Its purpose was to avoid the difficulty and inconvenience which attended the application of the statute upon the lakes of the northern frontier, where, as in the Straits of San Juan

de Fuca, the boundary line is a fixed line, but in practical navigation its position upon the waters would always be difficult to locate with certainty.

The decree is reversed and the case is remanded with instructions to dismiss the libel and to enter a decree for claimant.

---

---

United States Circuit Court of Appeals  
FOR THE NINTH CIRCUIT.

---

OCTOBER TERM, 1891.

---

THE UNITED STATES OF AMERICA,  
*Appellee,*

*v.*

THE STEAM TUG "PILOT," her Steam  
Engines, Boilers, Machinery, Tackle,  
Furniture, etc.,

and

JOAN OLIVE DUNSMUIR,

*Appellant.*

---

ARGUMENT FOR APPELLANT

IN OPPOSITION TO

Appellee's Motion to Vacate Decree and Dismiss Appeal.

---

BURKE, SHEPARD & WOODS,

*Attorneys for Appellant.*

---

---

FILED

JUL 11 1892



United States Circuit Court of Appeals  
FOR THE NINTH CIRCUIT.

---

OCTOBER TERM, 1891.

---

THE UNITED STATES OF AMERICA,	}
<i>Appellee,</i>	
<i>v.</i>	
THE STEAM TUG "PILOT," her Steam Engines, Boilers, Machinery, Tackle, Furniture, etc.,	}
and	
JOAN OLIVE DUNSMUIR,	
<i>Appellant.</i>	

---

---

ARGUMENT FOR APPELLANT

IN OPPOSITION TO

**Appellee's Motion to Vacate Decree and Dismiss Appeal.**

The United States of America, the appellee in this case, has filed a motion to vacate the decree of the Circuit Court of Appeals herein, "for the reason that this court has no jurisdiction in this case."

The case arose upon a libel in admiralty filed by the United States against the Steam Tug "Pilot," a British tug, for an alleged violation of Rev. Stats. § 4370, which

prohibits, under penalty of a fine, the towing, by steam tug boats not of the United States, of documented vessels of the United States plying from one port or place in the same to another, but which provides that "this section shall not apply to any case where the towing, in whole or in part, is within or upon foreign waters." The libel simply charged that the Pilot on May 3, 1891, towed an American bark, the Valley Forge, on her way from San Francisco, California, to Port Angeles, Washington, the said bark Valley Forge being then and there a documented vessel of the United States plying from one port or place in the same to another. The claimant's amended answer sets up the details of the towing complained of, showing that the Pilot picked up the Valley Forge in the waters of the Straits of San Juan de Fuca, near Vancouver Island and northward of the center line of the straits, and towed her thence to Port Angeles, whence, under the contract of towage, she was to tow her on to a British port north of the straits, but was prevented from so doing by the seizure to enforce which the libel was filed; and that said towing was in part within and upon foreign waters. The proofs showed the facts to be as averred in the answer. The District Court rendered a decree for the libellant for the statutory fine and costs, to reverse which the claimant prosecuted her appeal to this court. The court below held, in its opinion (48 Fed. Rep. 319) upon which its decree was founded, that "By treaty stipulations the boundary between the two countries is upon a line following the middle of the strait, and all that part of it north of the middle is British water, and all south of the line is American water;" but that because "by treaty the entire strait is free and open to both countries for the purposes of naviga-



tion, so that the vessels of each are free to sail anywhere in the strait upon either side of the line," therefore "It is my opinion that while this treaty remains, no part of the strait can be regarded as *foreign waters* to either American or British vessels. . . . And further, that the term 'foreign waters' as used in section 4370 means water under the exclusive dominion of a foreign government for all purposes. My conclusion is that foreign tugs are not privileged to tow American vessels bound from one American port to another, on either side of the strait; and that a penalty has been incurred by the tug Pilot as charged in the libel in this case."

The decision of this court was rendered on April 19, 1892, reversing the decree of the court below and remanding the cause with instructions to dismiss the libel, and to enter a decree for claimant. This decision is embodied in the opinion of his honor Judge Gilbert (50 Fed. Rep. 437), which thus states the case: "The question is presented whether the waters of the straits of San Juan de Fuca, lying north of the dividing line between United States and British Columbia, are 'foreign waters,' within the meaning of the statute." The opinion holds that "Notwithstanding the license of free navigation over the whole of the straits, which is reserved to each of the contracting parties" by the treaty between the United States and Great Britain of June 15, 1846, "a definite line of division is adopted which determines the limit of jurisdiction of each nation. All waters north of the line are British waters, subject to the control and dominion of Great Britain. All waters south of the line are American waters, and are under the jurisdiction of the United States."

The motion now made by the libellant and appellee, to vacate the decree of this court for the reason that it has no jurisdiction herein, is based, it is understood, upon the contention, now raised for the first time on the part of the United States, that in this case the construction of a treaty made under the authority of the United States is drawn in question, within the meaning of subd. 5 § 5 Ch. 517, Vol. 26 U. S. Stats. at Large, the "Circuit Court of Appeals Act" of March 3, 1891, and that therefore an appeal from the decree of the District Court lay directly to the Supreme Court of the United States under that section, and no appeal lay to this court under the provisions of § 6 of that act.

The question involved in the decision of this motion is, then, Did this case, as presented in the district court, "draw in question the construction" of the treaty of 1846? The appellant insists that it did not, that the case presented merely drew in question the construction of the words "foreign waters" in Rev. Stats. § 4370, and that hence her appeal was properly prosecuted to this court, and could not have been prosecuted to the Supreme Court of the United States.

On neither side do the pleadings in this case invoke any right derived under the treaty, or charge any obligation imposed by that treaty, or mention the treaty at all. The treaty appears for the first time, on the record, in the opinion of the judge below, who there invokes it as an aid to his determination of the meaning of the words "foreign waters" in the act of Congress under which the penalty was claimed.

The first answer to the motion, then, is that even if the

decision in this case does amount to a construction of that provision of the treaty adverted to by the learned judge below, making the navigation of the whole strait free and open to both nations, yet the construction of the treaty is not “drawn in question” upon the record of the case, or necessarily involved in its issues. It has been held repeatedly that to give it a federal court jurisdiction of the cause on the ground that a “federal question” is involved, the federal question must be distinctly and necessarily raised upon the record.

*Simmerman v. Nebraska*, 116 U. S. 54.

*Germania Ins. Co. v. Wisconsin*, 119 Id. 473.

*Spies v. Illinois*, 123 Id. 131.

*Brooks v. Missouri*, 124 Id. 394.

*Chappell v. Bradshaw*, 128 Id. 132.

*Clark v. Pennsylvania*, *Ib.* 395.

*Quimby v. Boyd*, *Ib.* 488.

*Texas & Pac. Ry. Co. v. So. Pac. Ry. Co.*, 137 Id. 48.

*Butler v. Gage*, 138 Id. 52.

But, secondly, is the construction of this treaty, even if not expressly drawn in question on the face of the record, necessarily involved in the determination of the issue raised upon the record?

This cannot be so, unless it becomes indispensable to refer to the treaty in order to determine what are foreign waters on our northwestern frontier. But it is not thus indispensable. The word “foreign” has a settled and definite meaning altogether apart from the provisions of that treaty, as was pointed out in the opinion of this court. “The word ‘foreign’ means belonging to another nation

or country ; belonging to or subject to another jurisdiction.” Now the United States, acquiring this northwestern territory by discovery and settlement, claimed sovereignty over an indefinite yet not an unlimited extent of the western portion of North America. Its claims were never pushed farther north than the parallel of  $54^{\circ} 40'$  ; they were finally compromised and settled, by the treaty of 1846, at the parallel of  $49^{\circ}$ . But suppose that the treaty of 1846 had never been made, or that, prior to it, the penal statute giving rise to this case had been in force, and that a case had arisen thereunder, involving the towing by a British tug of an American documented vessel picked up in the coast waters of the British Dominions on the parallel of  $60^{\circ}$ , or at any other locality in the northwestern waters of that part of British America wherein the United States had never disputed Great Britain’s sovereignty. Under such circumstances, could it reasonably be claimed that a court could not hold the towing to have been partly in foreign waters, because there had been no treaty fixing the hither limit of the foreign country ? The claimant of the tug would certainly have had the benefit of the saving clause of the statute, notwithstanding there were in existence no means of determining at what definite line the towing in foreign waters ceased and the towing in American waters began. It is not necessary, then, to refer to the text of the treaty of 1846 to ascertain what are foreign waters within the meaning of this penal statute. Foreign waters, with or without a treaty, are those “belonging to another nation or country ; belonging to or subject to another jurisdiction.”

The court below held in this case, however, and the counsel of the United States now insists, that the treaty

stipulation that the navigation of the whole of the straits shall remain free and open to both parties gives the United States a right to prosecute for the penalty imposed on a foreign tug for towing a documented vessel in American waters, where the towing is in part north of the international boundary line fixed by the treaty, the same as though the towing had been wholly on this side of the boundary, that is, wholly in what are *strictly* American waters. But to make this claim, even had it been seasonably and formally made in the record below, is not to claim a right under the treaty, which right is denied by the opposite party. It does not amount to a claim by the United States of a *right* derived from the treaty, for it does not go to the extent of a claim of *sovereignty* or *jurisdiction* over the waters of the straits lying north of the boundary line. It is a mere claim that the waters of the north half have from the provisions of the treaty derived a *character*, as “common waters,” which excludes them from the benefit of the exemption of “foreign waters” from the scope of the penal statute under consideration, by the saving clause of that statute. This claim, indeed, though not set out in the record, is made by the United States, and denied by the appellant. But the question thus raised is not, What is the construction of the treaty ; does it make the waters of the north half of the straits “foreign” within the meaning of the saving clause of the penal statute (enacted twenty years later)? But it is rather, What is the construction of the saving clause of the penal statute ; does its phrase “foreign waters” embrace such as, under the treaty, are free to the navigation of American vessels, though lying outside the international boundary line?

Again, the claim that the waters of the north half of the straits are “foreign” within the saving clause of the statute is not a claim of a right derived under the treaty, set up by the appellant and denied by the United States. For, as has been said, the waters north of our boundary and within another sovereignty are *foreign* apart from and in the absence of any treaty ascertaining the location of that boundary. The appellant claims the benefit of the exemption of foreign waters in the *statute*; she claims nothing that rests on the *treaty*; she makes no mention of it.

The statute is penal, and the burden lies on the libellant to bring the case both within its terms and without its exceptions. If the libellant seeks, by a reference to the treaty, to exclude the waters within which the towing was in part done from the scope of the saving clause in the statute, that is not a claim of a right derived under the treaty, but, as we have seen, a mere claim that waters over which no right of sovereignty or jurisdiction is asserted nevertheless derive from the treaty a certain *character* in the contemplation of our domestic penal laws; no more is it a denial of a right claimed by the appellant under the treaty, because the exemption from the penalty is claimed irrespective of the treaty. Viewed either as assertion or denial, the libellant’s contention on the merits amounts merely to urging a construction of the *statute* that will exclude from the scope of its saving clause waters that, otherwise foreign, are by the treaty made free and open to the navigation of both parties.

The attempt to give this case the aspect of involving the construction of a treaty goes farther than any of several in which the Supreme Court has disclaimed jurisdiction sought to be thrust upon it on that ground.

*Owings v. Norwood's Lessee*, 5 Cr. 344.

*Crowell v. Randell*, 10 Pet. 368.

*McDonough v. Millaudon*, 3 How. 693.

*Maney v. Porter*, 4 Id. 55.

*Gill v. Oliver's Exrs.*, 11 Id. 529.

*Carson v. Dunham*, 121 U. S. 421, 428-9.

*Metcalf v. Watertown*, 128 Id. 586.

As well, indeed, might the United States claim the appellate jurisdiction herein for the Supreme Court rather than this court, by contending that the case involves the construction of the Constitution of the United States, upon the ground, for instance, that the exception in the statute gives preference, by a regulation of commerce, to the ports of one state over those of another, by subjecting the towing business of ports that open on waters in part foreign to foreign competition from which it protects other ports entirely. Indeed, almost any case admits of some fanciful theory that a great constitutional right or a solemn treaty obligation hangs upon its decision. But such claims, along with the one now advanced in this case, are at war with the logic and spirit of the decisions by which the Supreme Court has carefully limited the scope of the judiciary act. This court had the jurisdiction of this appeal and the motion to vacate its decree should be denied.

BURKE, SHEPARD & WOODS,

*Attorneys for Appellant.*





# TRANSCRIPT OF RECORD.

---

---

UNITED STATES CIRCUIT COURT OF APPEALS  
FOR THE NINTH CIRCUIT.

OCTOBER TERM, 1891.

No. 33.

---

THE JOHNSON COMPANY,

APPELLANT,

*vs.*

PACIFIC ROLLING MILLS COMPANY,

APPELLEE.

---

TRANSCRIPT ON APPEAL.

(FROM U. S. CIRCUIT COURT, NORTHERN DISTRICT OF CALIFORNIA.)

---

---

FILED, FEBRUARY 18, 1892.

FILED  
FEB 24 1892



UNITED STATES CIRCUIT COURT OF APPEALS  
FOR THE NINTH CIRCUIT.

---

THE JOHNSON COMPANY,

APPELLANT,

*vs.*

PACIFIC ROLLING MILLS COMPANY,

APPELLEE.

---

TRANSCRIPT ON APPEAL.

(FROM U. S. CIRCUIT COURT, NORTHERN DISTRICT OF CALIFORNIA.)

---

INDEX.

	Original.	Print.
Answer .....	9	5
Assignment of Errors.....	90	60
Bill of Complaint.....	1	1
Bond on Appeal .....	95	62
Certificate to Enrollment.....	20	12
Certificate to Deposition .....	42	25
Certificate to Deposition.....	68	41
Complainant's Exhibit "Brevoort Diagram".....	45	27
Caption to Deposition .....	46	28
Complainant's Exhibit A.....	69	42
Complainant's Exhibit B.....	72	49
Complainant's Exhibit C.....	75	51
Complainant's Exhibit E.....	89	60
Decree .....	17	10
Deposition of Henry L. Brevoort.....	32	19
Deposition (introduction of evidence).....	47	28
Deposition of Patrick Noble.....	50	30
Enrollment .....	16	9
Exhibit "Drawing of Complainant's Exhibit E".....	44	26
Memorandum of costs and disbursements.....	18	10
Opinion .....	21	12
Order Allowing Appeal.....	94	62
Order Allowing Withdrawal of Original Exhibits.....	98	64
Petition for Order Allowing Appeal.....	92	61
Replication to Answer.....	15	9
Subpœna <i>ad respondendum</i> .....	7	4



1

*Bill of Complaint.*

Circuit Court of the United States, in and for the Northern District of California. In Equity.

No. 10393. February Session, 1889.

THE JOHNSON COMPANY

*vs.*

PACIFIC ROLLING MILLS COMPANY.

} Johnson Patent,  
} No. 272,554.

To the Honorable the Judges of the Circuit Court of the United States, in and for the Northern District of California.

The Johnson Company, a corporation organized by virtue of and under the laws of the State of Kentucky, and a citizen of that State, brings this its bill against the Pacific Rolling Mills Company, a corporation organized by virtue of and under the laws of the State of California, and a citizen of that State, and having its principal office in the city and county of San Francisco, in said State.

And thereupon your orator complains, and says that heretofore, on or about the 17th day of December, 1888, under and by virtue of the laws of the State of Kentucky, the name of the said Johnson Company was changed from the "Johnson Steel Street Rail Company" to "Johnson Company."

And your orator further shows unto your Honors, that heretofore, and before the twentieth day of February, A. D., 1883, Tom L. Johnson, of the city of Indianapolis, State of Indiana, was the true, original and first inventor of a certain new and useful improvement in street-railroad rail, not known or used before, and not in public use or on sale for more than two years prior to his application for a patent therefor.

2 And your orator further shows unto your Honors, that the said Tom L. Johnson, so being the inventor of the said improvement in street-railroad rail, made application to the proper department of the Government of the United States for letters patent in accordance with the then existing Acts of Congress, and duly complied in all respects with the conditions and requirements of the said Acts of Congress, and that on the twentieth day of February, A. D. 1883, Letters Patent Numbered 272,554, in due form of law, were issued and delivered to the said Tom L. Johnson, for the said invention or discovery, in the name of the United States of America, and under the seal of the Patent Office of the United States, and were signed by the Secretary of the Interior Department of the United States, and countersigned by the Commissioner of Patents, whereby there was granted to the said Tom L. Johnson, his heirs, executors, administrators or assigns, for the term of seventeen years from the twentieth day of February, A. D. 1883, the full and exclusive right of making, using and vending the said invention or

discovery throughout the United States and Territories thereof, as by said letters patent, or a duly authenticated copy thereof, ready in court to be produced, will more fully and at large appear.

And your orator further shows unto your Honors, that the said Tom L. Johnson, on the ninth day of March, A. D. 1883, by an instrument in writing, duly executed and delivered, and bearing date of the last named day, did assign unto your orator, the Johnson Company (formerly the Johnson Steel Street Rail Company) the whole right, title and interest in and to the said letters patent and the invention therein described, the said assignment having been duly recorded in the Patent  
3 Office of the United States on the thirtieth day of April, 1883, in Liber R. 29, page 184, as by the said assignment, or a duly authenticated copy thereof, ready in court to be produced, will more fully and at large appear.

And your orator further shows unto your Honors that, but for the infringement herein complained of, and others of like character, it would have been, and would still be, in the undisturbed possession, use and enjoyment, of the exclusive privileges secured by the said letters patent.

And your orator further shows unto your Honors that, as it is informed and believes, the said Pacific Rolling Mills Company, well knowing all the facts set forth, did make, use and sell the said patented improvement, or street-railroad rails, substantially the same in construction and operation as in the said letters patent are shown, described and claimed, the exclusive right to make, use and vend, which said patented street-railroad rails throughout the United States and Territories thereof, is by law vested in your orator.

And so it is, may it please your Honors, that the said respondent, as your orator is informed and believes, without the license of your orator, against its will and in violation of its rights, has made, used and vended, and intends to continue still to make, use and vend, the said patented improvement within the Northern District of California and elsewhere, all of which is in violation of the said letters patent, and to the great gain and profit of the respondent and to the great loss of your orator.

And now, to the end that the respondent may be compelled to account for and pay over the income thus unlawfully derived  
4 from the violation of the rights of your orator as above, and be restrained from any further violation of the said rights, your orator prays that your Honors may grant a permanent writ of injunction issuing out of and under the seal of this Honorable Court, directed to the said Pacific Rolling Mills Company.

Strictly enjoining and restraining it, its officers, agents and

employees from any further construction, use or sale in any manner, of said patented improvement in street-railroad rails, or any part or parts thereof, in the violation of the rights of your orator, and that all specimens of the said improvement, or any part or parts thereof, in the possession or use or under the control of the said respondent, the Pacific Rolling Mills Company, may be destroyed or delivered up to your orator for that purpose.

Your orator also prays that your Honors, upon the entering of a decree for an infringement, as above prayed for, may proceed to assess, or cause to be assessed, under your direction, in addition to the profits to be accounted for by the respondent aforesaid, the damages your orator has sustained by reason of such infringement, and that your Honors may increase the actual damages so assessed to a sum equal to three times the amount of such assessment, under the circumstances of the wilful and unjust infringement by the said respondent, as herein set forth.

And your orator prays also for a provisional or preliminary injunction against the said respondent, and for such other relief, together with the costs of the suit, as the equity of the case may require and to your Honors may seem meet.

To the end, therefore, that the respondent may, if it can show reason why your orator should not have the relief herein prayed for, and that the said respondent may make a  
5 full disclosure and discovery of all the matters aforesaid, under the oath of its proper officers, and according to the best and utmost of their knowledge, remembrance, information and belief, full, true, direct and perfect answer make to the several allegations of this bill, as though specially interrogated relative thereto.

May it please your Honors to grant unto your orator, not only a writ of injunction conformable to the prayer of this bill, but also a writ of subpœna of the United States of America, issuing out of and under the seal of this Honorable Court, directed to the respondent herein, the said Pacific Rolling Mills Company, commanding it to appeal and answer unto this bill of complaint, and to abide by and perform such order and decree in the premises as to the Court shall seem meet, and be required by the principles of equity and good conscience.

And your orator will ever pray.

GEORGE HARDING,  
*Solicitor for Complainant.*

GEORGE HARDING,  
WM. F. BOOTH,  
GEORGE J. HARDING,  
BUTLER KENNER HARDING,  
*Of Counsel for Complainant.*

6 STATE OF PENNSYLVANIA, }  
*County of Cambria,* } ss.

Arthur J. Moxham, being duly sworn according to law, doth depose and say: That he is the President of the corporation, the Johnson Company, the complainant named in the foregoing bill of complaint; that he has read the foregoing bill of complaint and knows the contents thereof, and that so far as the statements therein contained are within his own knowledge, they are true, and so far as they are derived from the information of others, he verily believes them to be true.

And he further doth depose and say: That he verily believes the said Tom L. Johnson, in the said bill of complaint named, to be the true, original and first inventor of the street-railroad rails which are described in the said letters patent granted to him, and mentioned in the foregoing bill of complaint.

And he doth further depose and say: That he verily believes the title of complainant as set forth in the said bill is true.

ARTHUR J. MOXHAM.

Subscribed and sworn to before me this 13th day of May, A. D. 1889.

[SEAL.]

A. MONTGOMERY.

*A Notary Public of the State of Pennsylvania,  
in and for the County of Cambria.*

(Endorsed:) Filed June 4th, 1889. L. S. B. Sawyer, Clerk.

*Subpoena.*

UNITED STATES OF AMERICA:

Circuit Court of the United States, Ninth Judicial Circuit,  
Northern District of California. In Equity.

The President of the United States of America, Greeting: To the Pacific Rolling Mills Company, a corporation, organized by virtue of and under the laws of the State of California.

You are hereby commanded, That you be and appear in said Circuit Court of the United States aforesaid, at the court room in San Francisco, on the first day of July, A. D. 1889, to answer a Bill of Complaint exhibited against you in said Court by the Johnson Company, a corporation, organized by virtue of and under the laws of the State of Kentucky, and a citizen of that State, and to do and receive what the said Court shall have considered in that behalf. And this you are not to omit, under the penalty of five thousand dollars.



Witness, the Honorable Melville W. Fuller, Chief Justice of the Supreme Court of the United States, this 4th day of June, in the year of our Lord one thousand eight hundred and eighty-nine, and of our independence the 113th.

[SEAL.]

L. S. B. SAWYER, *Clerk.*

*Memorandum Pursuant to Rule 12, Supreme Court U. S.*

You are hereby required to enter your appearance in the above suit, on or before the first Monday of July next, at the Clerk's Office of said Court, pursuant to said bill; otherwise the said bill will be taken *pro confesso*.

L. S. B. SAWYER, *Clerk.*

(Endorsed:)

UNITED STATES MARSHAL'S OFFICE,  
NORTHERN DISTRICT OF CALIFORNIA.

I hereby certify that I received the within writ on the 4th day of June, 1889, and personally served the same on the 5th day of June, 1889, upon the Pacific Rolling Mills Company, by delivering to and leaving with Wm. Alvord, President of the Pacific Rolling Mills Company, said defendant named therein, personally, at the City and County of San Francisco, in said District, an attested copy thereof.

J. C. FRANKS,

*U. S. Marshal,*

By JAMES R. DEANE,

*Deputy.*

San Francisco, June 5th, 1889.

Filed June 5, 1889.

L. S. B. SAWYER, *Clerk.*

*Answer.*

In the Circuit Court of the United States, Ninth Circuit, in and for the Northern District of California.

THE JOHNSON COMPANY, Complainant,

*vs.*

PACIFIC ROLLING MILLS COMPANY, Defendant.

The answer of the Pacific Rolling Mills Company, the defendant to the bill of complaint of the complainant, herein filed.

This defendant now, and at all times hereafter, saving and reserving unto itself all benefit and advantage of exception which can or may be had or taken to the many errors, uncertainties and other imperfections in the said complainant's said

bill of complaint contained, for answer thereto, or unto so much and such parts thereof as this defendant is advised, is or are material or necessary for it to make answer unto, this defendant, for answering, saith:

That the defendant admits that Letters Patent Numbered 272,554, and bearing date on the 20th day of February, 1883, for an alleged improvement in street railroad rails, were granted by the Government of the United States to Tom L. Johnson, as alleged in the said bill. But the defendant denies that the alleged invention which was covered by said letters patent was either new or useful; on the contrary, the defendant avers that it is informed and believes, and so states to be true, that the said alleged improvement which was covered by said letters patent has never been used by the owners  
10 of said letters patent or by anyone else, for the reason that it was not useful. That the said alleged invention was for rolling said rails in a peculiar form, and that said form was injurious and not beneficial to said rails, and the same was not and never has been of any utility, or of any value whatever.

Defendant denies that the said letters patent are valid, or that they cover or protect any patentable invention, or that they have secured to the said Tom L. Johnson, or his assigns, any exclusive right of making, or using, or vending the said alleged invention or discovery throughout the United States, or any part thereof, or in any place, or for any time.

Defendant avers that it is not informed, save by said bill, as to whether said letters patent were assigned to the Johnson Steel Street Rail Company, as alleged in said bill, or not. It therefore denies that the same were so assigned, and leaves the complainant to make such proof thereof as it may be advised and be able to do.

Defendant further says that it is not advised, save by said bill, whether the name of the Johnson Steel Street Rail Company was changed to "Johnson Company," as alleged in said bill, or not; it therefore denies that the said name was so changed, and leaves the complainant to make proof thereof as it may be able to do.

This defendant denies that, except for the infringement complained of, or any infringements, the complainant would be in the undisturbed use and enjoyment of the exclusive privileges secured by the said letters patent. On the contrary, the defendant avers that it is informed and believes, and so states to be true, that the said letters patent never have been infringed and the possession by the complainant of the alleged invention has never been disturbed; but notwithstanding these facts, the complainant has neither used or en-  
11 joyed the said exclusive privileges, or any of them.

This defendant, the Pacific Rolling Mills Company denies that it has either made or used or sold the said patented improvement or any steel railroad rails, or any railroad rails which were substantially, or at all, the same in construction, or operation, as those shown, described and claimed in the said letters patent. This defendant denies that it has ever made, or has ever used or has been vended, or that it intends, or ever intended, or that it will under any circumstances either make, or use or vend in the future, the said patented improvement, either within the Northern District of California, or in any place whatever, either to the great gain and profit of this defendant, or to the great loss of the complainant or at all.

And this defendant denies that it has infringed upon said letters patent, or that it is now infringing upon said letters patent, or that it will in the future infringe upon said letters patent, and denies that it intends or ever intended to infringe upon said letters patent; and denies that it has obtained, or in any way realized any income, or gains, or profits from any infringement of said letters patent, and denies that the complainant has sustained any loss or any damage or that it will sustain any loss or any damage on account of any infringement of said letters patent by this defendant.

And further answering this defendant avers that it is informed and believes and so states to be true, that the said letters patent are null and void for the reason that the effects stated therein will not be produced by the means therein described for producing those effects. Defendant avers that the pocket formed between the head and foot of the rail described therein will not clasp and hold street ballast and thereby  
12 prevent the wearing away of the street alongside of said rail as stated in the said bill of complaint. Neither are the masses of metal in the head, web, flange and foot of the rail described in the patent so nearly equal that all parts will shrink alike and obviate the necessity of cambering in rolling said rails as stated in said patent, and defendant states generally that the changes which are claimed in said patent to be produced by the peculiar forms therein described will not be so produced by those forms.

Defendant avers and will prove on the trial of this case that street railroad rails similar to those described in said letters patent and with pockets formed on each side of the webs thereof, for the reception of the street ballast long prior to the alleged invention of the patentee, Tom L. Johnson, were in public use on California street, between Kearny and Larkin streets, in the City and County of San Francisco in the State of California. That the same were so used by the California Street Railroad Company, which had, and still has, its principal place of

business and residence at the southeast corner of said California and Larkin streets in said City and County of San Francisco.

This defendant further avers and will prove on the trial of this cause that street railroad rails, similar to those described in said letters patent, and with pockets formed on each side of the webs thereof for the reception of street ballast as therein described, were shown and described in the following described letters patents, each one of which was granted by the government of the United States to Henry Root of the City and County of San Francisco, viz:

13 Letters Patent Numbered 262,126, applied for on the third day of September, 1881, and bearing date on the first day of August, 1882, and being granted for a "Construction of Cable Railways."

Also Letters Patent Numbered 247,781, applied for on the sixth day of May, 1881, and bearing date on the fourth day of October, 1881, and being granted for a "Cable Railroad."

And further answering, the said defendant denies that the said complainant is entitled to the relief or any part thereof in the said bill of complaint demanded. And this defendant prays the same advantage of its aforesaid answer, as if it had pleaded or demurred to the said bill of complaint, and this defendant prays leave to be dismissed with its reasonable costs and charges in this behalf most wrongfully sustained.

M. A. WHEATON,  
*Solicitor for Defendant.*

M. A. WHEATON,  
*Of Counsel for Defendant.*

STATE OF CALIFORNIA, }  
*City and County of San Francisco,* } *ss.*

William Alvord, being duly sworn, does depose and say, that he is the President of the Pacific Rolling Mills Company, the defendant in the foregoing answer, and that by means of his said office he has acquired and possesses particular knowledge of the matters stated in said answer; that he has read the foregoing answer and knows the contents thereof, and that the same is true of his own knowledge except as to the matters therein stated on information and belief,  
14 and as to those matters he verily believes it to be true.

WILLIAM ALVORD.

Subscribed and sworn to before me, this 5th day of August, A. D. 1889.

[SEAL.]

JAMES MASON,  
*Notary Public.*

(Endorsed:) Service of the within answer and receipt of a copy thereof admitted this 5th day of August, 1889. Wm. F. Booth, Solicitor for Plaintiff. Filed 5th day of August, A. D. 1889. L. S. B. Sawyer, Clerk.

15 *Replication to Answer.*

In the Circuit Court of the United States, Ninth Judicial Circuit, in and for the Northern District of California.

THE JOHNSON COMPANY, Complainant,	) In Equity. } No. 10393.
vs.	
PACIFIC ROLLING MILLS COMPANY, Respondent.	) Replication.

This repliant, saving and reserving unto itself all and all manner of advantage of exception to the manifold insufficiencies of the said answer, for replication thereunto saith, that it will aver and prove its said bill to be true, certain, and sufficient in the law to be answered unto; and that the said answer of the said defendant is uncertain, untrue, and insufficient to be replied unto by this repliant; without this, that any other matter or thing whatsoever in the said answer contained, material or effectual in the law to be replied unto, confessed or avoided, traversed or denied, is true; all which matters and things this repliant is, and will be, ready to aver and prove, as this Honorable Court shall direct; and humbly prays, as in and by its said bill it hath already prayed.

WM. F. BOOTH,  
*Of Counsel for Complainant.*

Service of the above replication admitted this 2nd day of September, 1889.

M. A. WHEATON,  
*Defendant's Solicitor.*

(Endorsed:) Filed Sept. 2nd, 1889. L. S. B. Sawyer, Clerk.  
By F. D. Monckton, Deputy Clerk.

16 *Enrollment.*

In the Circuit Court of the United States, Ninth Circuit, Northern District of California.

THE JOHNSON Co., Complainant,	} No. 10393.
vs.	
PACIFIC ROLLING MILLS Co., Respondent.	

The complainant filed its bill of complaint on the 4th day of June, 1889, which is hereto annexed.

A subpoena to appear and answer in said cause was thereupon issued, returnable on the 1st day of July, A. D. 1889, which is hereto annexed.

The respondent appeared herein on the 1st day of July, 1889, by M. A. Wheaton, Esqr., its solicitor.

On the 5th day of August, 1889, an answer was filed herein, which is hereto annexed.

On the 2nd day of September, 1889, a replication was filed herein and is hereto annexed.

Thereafter a final decree was filed and entered herein in the words and figures following, to wit:

17

*Decree.*

At a stated term, to wit: the July term, A. D. 1891, of the Circuit Court of the United States of America, of the Ninth Judicial Circuit, in and for the Northern District of California, held at the court room in the City and County of San Francisco, on Monday the 27th day of July, in the year of our Lord one thousand eight hundred and ninety-one.

Present: The Honorable Thomas P. Hawley, U. S. District Judge, District of Nevada.

THE JOHNSON COMPANY,  
*vs.*  
 PACIFIC ROLLING MILLS COMPANY. } No. 10393.

This cause came on to be heard at the July, 1890, term of said Court, and was argued by counsel, and submitted to the Court for consideration and decision.

Thereupon, upon consideration thereof, it is ordered, adjudged and decreed that the complainant's bill of complaint herein, be and the same hereby is dismissed at complainant's cost, taxed at \$89.75.

(Signed) HAWLEY,  
*Judge.*

(Endorsed:) Filed and entered July 27, 1891. L. S. B. Sawyer, Clerk.

18

*Memorandum of Costs and Disbursements.*

United States of America. Circuit Court of the United States,  
 Ninth Circuit, Northern District of California.

THE JOHNSON COMPANY, Complainant, } Memorandum  
*vs.* } of Costs and  
 PACIFIC ROLLING MILLS COMPANY, Defendant. } Disbursements

Disbursements:

Copy of the bill of complaint.....\$ 2 00  
 Clerk's fees..... 10 00

Deposition fees for 2 witnesses, Henry L. Brevoort and Patrick Noble, at \$2.50 each.....	\$5 00
Examiner's fees.....	52 00
Docket fee.....	20 00
Affidavit to answer.....	50
Affidavit to cost bill.....	25

Taxed at.....Total sum..\$89.75

L. S. B. SAWYER,  
*Clerk.*

UNITED STATES OF AMERICA,  
*Northern District of California,* } *ss.*  
*City and County of San Francisco,* }

F. J. Kierce being duly sworn, deposes and says: That he is one of the solicitors for the defendant in the above entitled cause, and as such is better informed, relative to the above costs and disbursements, than the said defendant.

That the items in the above memorandum contained are correct, to the best of this deponent's knowledge and belief, and that the said disbursements have been necessarily incurred in the said cause.

(Signed) F. J. KIERCE.

Subscribed and sworn to before me, this 30th day of July, A. D. 1891.

F. D. MONCKTON,  
*Commissioner of U. S. Circuit Court,*  
*Northern District of California.*

To Messrs. George Harding, G. J. Harding and Wm. F. Booth,  
Solicitors for Complainant:

You will please take notice that on Saturday, the first day of August, A. D. 1891, at the hour of 10:30 o'clock, A. M., we will apply to the Clerk of said Court to have the within memorandum of costs and disbursements taxed pursuant to the rule of said Court, in such case made and provided.

WHEATON, KALLOCH & KIERCE,  
*Solicitors for Defendant.*

(Endorsed:) Service of within memorandum of costs and disbursements, and receipt of a copy thereof acknowledged, this 30th day of July, A. D. 1891. Wm. F. Booth, Solicitor for Complainant. Filed this 31st day of July, A. D. 1891. L. S. B. Sawyer, Clerk.

20

*Certificate to Enrollment.*

Whereupon, said pleadings, subpoena and final decree and a memorandum of taxed costs are hereto annexed, said final decree being duly signed, filed and enrolled, pursuant to the practice of said Circuit Court.

Attest, etc.

[SEAL.]

L. S. B. SAWYER, *Clerk.*

(Endorsed:) Enrolled papers. Filed July 27, 1891. L. S. B. Sawyer, Clerk.

21

*Opinion.*

In the Circuit Court of the United States, Ninth Judicial Circuit, Northern District of California.

JOHNSON COMPANY, Complainant,	}	No. 10393.
<i>vs.</i>		
PACIFIC ROLLING MILLS COMPANY, Respondent,	}	No. 10394.
AND		
JOHNSON COMPANY, Complainant,	}	No. 10394.
<i>vs.</i>		
SUTTER STREET RAILWAY COMPANY, Respondent.		

July 27, 1891.

WM. F. BOOTH and HARDING & HARDING, for complainants,  
both cases: WHEATON, KALLOCH & KIERCE, and NAPHTALY,  
FREIDENRICH & ACKERMAN, for respondents.

HAWLEY, J.

These cases were tried together, and involved precisely the same questions.

They are actions in equity to recover for an alleged infringement of Letters Patent Number 272,554, bearing date February 20, 1883, granted to Tom L. Johnson, for a street railroad, and by him assigned to the corporation complainant in both cases. The alleged infringement is for the manufacture and sale of certain rails by the Pacific Rolling Mills Company in one case, and in the other case, for the use of said rails by the Sutter Street Railway Company.

The specifications of the patent are quite lengthy. The following quotations therefrom have more or less bearing upon the points involved:

22        "The object of my said invention is to improve the form of that class of railroad rail, used principally by street railroads, which combine the principal features of the tramrail, ordinarily used for such purposes, and those of the T-rail used on steam railroads.



“ I am aware that rails embodying the general features above mentioned are old, and I therefore disclaim the same, and confine myself to the form hereinafter particularly described and claimed as new.

“ Referring to the accompanying drawings, which are made a part hereof, and on which similar letters of reference indicate similar parts, Figure 1 is a perspective view of a portion of a rail formed in accordance with my invention, and Fig. 2, a transverse vertical section of the same. Fig. 3 shows a section of a street railway bed and ordinary rails as commonly laid.

“ In said Figs. 1 and 2 the letter A indicates the flanged portion of the rail; B, the head of the rail; C, an offset under the head of the rail, abutting the web E on the side of said web, opposite to that continued out in the flange A. The web E extends from the foot D to the angles respectively formed on opposite sides by its union with the offset C and flange A, thus securing a uniform depth of web proper for the fish-plates to clamp.

“ In Fig. 3 the letter G indicates an ordinary cross-tie, the letters HH, stringers, such as are ordinarily used upon street railways, and KK an ordinary form of street rail laid thereon. The letters *xx* indicate the edges of the adjacent and underlying roadway.

“ A peculiar and important feature of this rail is the offset C, which, while serving the purpose of a close fit for the splice-bar or fish-plate, as above mentioned, also serves another equally or more important purpose in the general conformation of and peculiar disposition of metal in the rail.”

“ The splice-bar offset C, is a large factor, in the proper retaining of this ballast, for it is large enough with its square corner, in connection with the curved or arched shape of the lower part of the head and T shaped foot to allow the surrounding and superincumbent traffic to press the ballast—gravel and stones of the streets—into and against the rail, instead of (as shown in Fig. 3—cutting away the surface of the street from the rails.”

There are six claims to the patent; but only one—the fifth—that it is contended is infringed. This claim reads as follows: “ 5. In the combined tram and T rail described, the web E, located relatively to the flange A, and head B, offset at C, as described, whereby a maximum capacity of outside pocket is secured with a minimum quantity of metal consistent with the proper stability of the rail, substantially as set forth.”

The defenses to this patent, set up by defendants, are (1) non-infringement (2) non-patentability.

1. In construing the patent it is the duty of the Court to confine its deliberations to the fifth claim as that is the only one

that is claimed to be infringed. It is also proper to restrict the interpretation of the patent to the particular class to which it belongs, viz: to patents for mere form, as distinguished from patents involving mechanical action or patents for some particular kind of process. This case is one "where in view  
24 of the state of the art, the invention must be restricted to the form shown and described by the patentee."

*Duff vs. Sterling Pump Co.*, 114 U. S., 639.

The fifth claim required the web E, to be located relatively to the flange A, and head B, as described. This relative location, when compared with the drawings and specifications places the head B, to the left hand side of the vertical line of the web E, and the whole of the upper face of the flange A, over the whole width of the web. The form of the defendant's rail, in this respect, locates the head over the web, and the flange is to the right of the vertical line of the web. The difference in the relative location of the different parts of the patented rail and of the defendant's rail is shown in the cross-examination of complainant's expert witness, Breevort, who, in answer to questions, testified as follows:

"Q. 8. In the patented rail is there any part of the head that is over the web in a vertical line?

"A. No.

"Q. 9. In the defendant's rail is the head in vertical line over the web or not?

"A. The head is over the web.

"Q. 10. Then in this respect referred to in the last two questions is the relative location of the head and web, the same in the defendant's rail as it is in the patented rail?

"A. It is not.

"Q. 11. In the patented rail is the flange in a vertical line over the web.

"A. Yes.

"Q. 12. In the defendant's rail is the flange in a vertical line over the web?

"A. No.

25 "Q. 13. Then in this respect is the relative location between the web and the flange the same in the defendant's rail as it is in the patented rail?

"A. No."

If, therefore, the patent is to be limited to the form that results from having "the web E located relatively to the flange A and head B, as described," it would seem to follow that there is no infringement by the defendant's rail.

The relative location between the web, the head and the flange is made—by the fifth claim—a material part of the form of the patented rail, as distinguished from the prior state of

the art; and in connection with the offset C, constitutes the "Improvement in street railroad rails" for which the patent was obtained.

When a claim is so explicit the courts cannot alter or enlarge it. If the patentee has not claimed the whole of his invention, and the omission was the result of inadvertence, he should have sought to correct the error by a surrender of his patent and an application for a re-issue. He cannot expect the courts to wade through the history of the art and spell out what he might have claimed, but has not. "Since the act of 1836, the patent laws require that an applicant for a patent shall, not only by a specification in writing, fully explain his invention, but that he shall particularly specify and point out the part, improvement or combination which he claims as his own invention or discovery. This provision was inserted in the law for the purpose of relieving the courts from the duty of ascertaining the exact invention of the patentee by inference and conjecture, derived from a laborious examination of previous inventions, and a comparison thereof with that claimed by him. This duty is now cast upon the Patent Office. There his claim is, or is supposed to be, examined, scrutinized, limited and made to conform to what he is entitled to. If the office refused to allow him all he asks, he has an appeal. But the courts have no right to enlarge a patent beyond the scope of its claim as allowed by the Patent Office, or the appellate tribunal to which contested applications are referred. When the terms of a claim in a patent are clear and distinct, as they always should be, the patentee, in a suit brought upon the patent, is bound by it. *Merrill vs. Yeomans*, (*ante*, 235.) He can claim nothing beyond it. But the defendant may at all times, under proper pleadings, resort to prior use and the general history of the art to assail the validity of a patent or to restrain its construction. The door is then opened to the plaintiff to resort to the same kind of evidence in rebuttal; but he never can go beyond his claim. As patents are produced *ex parte*, the public is not bound by them, but the patentees are. And the latter cannot show that their invention is broader than the terms of their claim; or, if broader, they must be held to have surrendered the surplus to the public."

*Keystone Bridge Co vs. Phoenix Ins. Co.*, 95 U. S. 278.

See also *Railroad Co. vs. Mellon*, 104 U. S., 118.

*Sargent vs. Hall Safe and Lock Co.*, 114 U. S., 86.

*Western Electric Co. vs. Ansonia Co.*, 114 U. S., 452.

*Clark vs. Beecher M. Co.*, 115 U. S., 86.

*Yale Lock Co. vs. Greenleaf*, 117 U. S., 588.

2. The contention of defendants—with reference to the defense of non-patentability—is, “that the complainant’s patent is absolutely void, for the reason that it is only for one especial form of the well known girder rails and that such especial form did not develop any new or unknown mode of operation.”

27 It is undoubtedly true, as has often been said, that no more difficult task can be imposed upon the Court in patent cases, than that of determining what constitutes invention, and of drawing the line of distinction between the work of the inventor and the constructor. It is very often difficult to determine what degree of improvement takes a case out of the mere exercise of mechanical skill and judgment and places it within the domain of invention or discovery. Certain well defined general principles have, however, from time to time, been announced in plain, clear and distinct terms, which are calculated to materially aid the courts in deciding cases of like character with the cases under consideration.

The Supreme Court “has repeatedly held that, under the Constitution and the Acts of Congress, a person, to be entitled to a patent must have invented or discovered some new and useful art, machine manufacture, or composition of matter, or some new and useful improvement thereof, and that ‘it is not enough that a thing shall be new, in the sense that in the shape or form in which it is produced it shall not have been before known, and that it shall be useful, but it must, under the Constitution and the statute, amount to an invention or discovery.’” *Hill vs. Wooster*, 132 U. S., 700. “The cases on this subject are collected in *Thompson vs. Boissilier*, 114 U. S., 1, 11, 12, to them may be added *Stephenson vs. Brooklyn Railroad*, 114 U. S., 149; *Yale Lock Co. vs. Greenleaf*, 117 U. S., 544; *Gardner vs. Herz*, 118 U. S., 180; *Pomaco Holder Co. vs. Ferguson*, 119 U. S., 335; *Hendy vs. Miners Iron Works*, 127 U. S., 370, 375; *Holland vs. Shipley*, 127 U. S., 396; *Pattee Plow Co. vs. Kingman*, 129 U. S., 294; *Brown vs. District of Columbia*, 130 U. S., 87; *Day vs. Fairhaven and Westville Railway Co.*, 132 U. S., 98; *Watson vs. Cincinnati, Indianapolis, etc., Railway Co.*, 132 U. S., 161; *Marchand vs. Enken*, 132 U. S., 195; *Royer vs. Roth*, 132 U. S., 201.

In the light of these principles the facts in these cases as shown by the evidence, must be applied and considered in order to enable the Court to determine upon which side of the border line the patent falls.

The prior art is represented by the ordinary T-rail and the California street rail. Neither of these rails possessed all the advantages of the patented rail. In fact the object of the patentee in changing the form of the rail—as stated in his speci-

fications heretofore quoted—was to secure in one form all the advantages possessed by the rails then in public use. The general features of his invention were admitted to be old and he therefore disclaimed the same and confined himself “to the form hereinafter particularly described and claimed as new.”

The advantages testified to by complainant’s witness, Breevort, that the patent rail “is adapted to be placed on a sleeper below the street level so that the paving can be brought up to it—it has a head for the bearing of the wheel, a flange which permits ordinary street traffic, a vertical web and foot,” were all possessed by the California street rail.

Speaking of the California street rail, the witness said: “The said rail has not got the same disposition of metal or the same combination of parts as claimed in the fifth claim of the patent. It is true that the sample of rail shown me has a head, a flange, a web, and a foot, but these parts are differently shaped and are differently located in regard one to the other, when compared with either the defendant’s or the complainant’s rail. The rail shown me has an offset under the head, and if such a rail, was used with fish-plates, one set of fish-plates would have to be used for the side of the rail on which the head was turned, and another and narrower set of fish-plates would have to be used for that side of the rail on which the flange is turned. Both in the defendant’s and complainant’s rail, the offset under the head enables fish-plates of like size to be used on both sides of the rail, besides furnishing strength to the head. In the sample of rail shown me, strength for the head has been obtained by a different disposition of metal, and the offset has been dispensed with.”

The flanged rails are shown by the testimony of both parties to be advantageous, by reason of their adaptability for street paving. The California street rail is a flanged rail and in this respect it was an improvement upon the T-rail. This advantage is secured in the form of the patented rail. The advantage of even fish-plating in the patented rail was obtained by the use of the offset C, and this is the most prominent feature upon which the invention of the patented rail is claimed. The form of the California street rail did not admit of even fish-plating. The old T-rail, however, had that advantage. Its form was such as to allow even fish-plating. The rails were even on both sides and the plates could be transferred from one side to the other and only one size of plates were required to be purchased. It will thus be seen as stated by complainant’s witness, Breevort, that “the patent of Johnson described an improved form of rail, intended principally for use in streets for car service and street railway service. The said rail described in the patent is designed to present many of the advantages of the T-rail

30 and possessing also some of the advantages of the ordinary tram-rail." The change in the form of the rail so as to secure these advantages, as shown by the evidence, was, in my opinion, the result of ordinary mechanical skill, which did not require the exercise of the inventive faculty of the mind.

In *Busell Trimmer Co. vs. Stevens*, the Supreme Court, in passing under a similar question involved in that case, said:

"Effort was made to show by other witnesses that the features in the Orcutt patent, specified in the statement of counsel above quoted, are all patentable novelties, especially the combination of them into one devise. We repeat, that in view of the previous state of the art we think otherwise. The evidence, taken as a whole, shows that all of those claimed elements are to be found in various prior patents—some in one patent, and some in another, but all performing like functions in well-known inventions having the same object as the Orcutt patent, and that there is no substantial difference between the Brown metal cutter and Orcutt's cutter, except in the configuration of their molded surface. That difference, to our minds, is not a patentable difference, even though the one cutter was used in the metal art, and the other in the leather art. A combination of old elements, such as are found in the patented device in suit, does not constitute a patentable invention." 137 U. S., 433.

The changes made by Johnson in the form of the rail were changes of degree only, and did not involve any new principle. It was a combination of old elements into a new form without producing any new mode of operation. It is, as was said by the Supreme Court in *Burt vs. Evory*, 133 U. S., 358, "a mere aggregation of old parts with such changes of form or  
31 arrangement as a skillful mechanic could readily devise—the natural outgrowth of the development of mechanical skill as distinguished from invention. The changes made—in the construction—were changes of degree only and did not involve any new principle—performed no new function."

In *Florsheim vs. Shilling*, 137 U. S., 77, the Supreme Court adopted the rule announced in *Pickering vs. McCullough*, 104 U. S., 318. "In a patentable combination of old elements all the constituents must so enter into it as that each qualifies every other. It must form either a new machine of a distinct character or function, or produce a result due to the joint and co-operating action of all the elements, and which is not the mere adding together of separate contributions. The combination of old devices into new articles, without producing any new mode of operation, is not invention." *Burt vs. Evory*, *supra*. See also *Hailes vs. Van Wormer*, 20 Wall., 353; *Recken-*

*dorfer vs. Faber*, 92 U. S., 347; *Tack Co. vs. Two Rivers Manufacturing Company*, 109 U. S., 117; *Bussey vs. Excelsior Manufacturing Company*, 110 U. S., 131; *Phillips vs. Detroit*, 111 U. S., 604; *Stephenson vs. Brooklyn Railroad Co.*, 114 U. S. 149; *Beecher M'f'g Co. vs. Atwater M'f'g Co.*, 114 U. S., 523; *Thatcher Heating Co. vs. Burtis*, 121 U. S., 286; *Hendy vs. Miners Iron Works*, 127 U. S., 370. See also *Campbell vs. Bailey*, 45 Fed. R., 564, and authorities there cited.

The contention of defendants is, in my opinion, sustained, and complainant's bills must be dismissed. It is so ordered.

(Endorsed:) Opinion read in open Court July 27, 1891. L. S. B. Sawyer, Clerk.

32 *Deposition of Henry L. Brevoort.*

U. S. Circuit Court, Northern District of California.

JOHNSON COMPANY  
*vs.*  
 SUTTER STREET RAILWAY COMPANY. } In Equity.  
 No. 10,394.

JOHNSON COMPANY  
*vs.*  
 PACIFIC ROLLING MILLS COMPANY. } In Equity.  
 No. 10,393.

Testimony taken on behalf of complainant in above entitled causes before R. G. Monroe, Notary Public, special examiner, at his office, No. 140 Nassau St., New York, N. Y., April 29th, 1890.

Present: Geo. J. Harding, Esq., for complainant; M. A. Wheaton, Esq., for defendant.

It is stipulated that R. G. Monroe act as special examiner in these causes, and that the testimony taken before him shall have the same force and effect as if taken before a standing examiner of this Court.

It is further stipulated that the proof taken shall be read as taken separately in each suit.

HENRY L. BREEVOORT, a witness called on behalf of the complainant, having been first duly sworn, testified as follows:

Q. 1. What is your name, age, residence and occupation?

A. Henry L. Brevoort; 41 years; Brooklyn, N. Y.; Engineer.

Q. 2. What qualifications have you for testifying in this case?

33 A. As a boy I learned the trade of a machinist and for a number of years owned and operated a machine shop. For the last fifteen or sixteen years I have been almost exclusively

engaged in examining patents and patented devices and I have, during this period, been called upon to testify in suits relating to patents, having testified in many hundred of such cases.

Q. 3. Have you examined and do you understand the letters patent in suit?

A. I have read it and I think I understand what is described and claimed in said patent.

Q. 4. Have you examined certified copy of Complainant's Ex. E, and do you understand the same? I now show you a section of a rail. Please state how said section compares with the drawing, Exhibit E.

A. I have examined the Ex. E and I understand the rail there shown in section. I have compared the section of rail shown me with the said exhibit and I find that the said section is practically the same as the drawing, Exhibit E.

Said section is here offered in evidence and marked "Complainant's Exhibit Section Defendant's Rail."

Q. 5. Please compare Comp'ts. Ex. E and the rail section last offered with the rail set out and described in complainant's patent and specifically pointed out in the fifth claim thereof and state wherein you find similarity or identity of structure between said exhibit and rail section and the patent in suit?

A. I have made the comparison called for in the question between the patent in suit, No. 272,554, dated Feb. 20th, 1883, and granted to Tom L. Johnson, and the rail marked Ex. E, and also the section of the actual rail, and I think that  
34 the said defendant's rail contains the invention of the fifth claim of the patent in suit. I will give my reasons for this opinion.

(Defendant objects to the answer so far given and also the answer the witness proposes to give in so far that it contains the opinion of the witness as to what invention is or is not described in or covered by said claim five, upon the ground that the same is giving a construction of the claim by the witness, and it is therefore incompetent testimony.

Defendant here also puts in an objection to all opinions of the witness which may be hereafter given as to what invention or inventions are or are not covered by any of the respective claims of the patent, upon the ground that the same is incompetent testimony, for the reason that they give a construction to the patent and its claims, and thus trench upon the exclusive province of the Court. This objection is put in here to apply to all such testimony for the purpose of saving a constant repetition of the objection).

The patent of Johnson describes an improved form of rail intended principally for use in streets for car service or street rail-



way service. The rail described in the patent is designed to present many of the advantages of the T-rail and possessing also some of the advantages of an ordinary tram-rail. By making the rail deep like the T-rail ordinarily used on steam roads; the support of the rail can be placed below the street level and the paving can be brought close up on either side to the rail, and above the supporting sleeper.

The rail is also made stiff and ridged by its depth of flange. The rail of the patent is one having a head (lettered B in the patent) which is to be placed in laying the rail slightly  
35 above or level with the surrounding street surface.

There is a flange A which may be just below the street level and which prevents the wheels of ordinary vehicles to find a track between the heads of the rails composing the road. The head and flange are carried by the web marked E in the patent, located below the junction of the head and flange. This web terminates at its base in a foot, D, which is adapted to run upon and be spiked to this sleeper, upon which the rail is laid. Under the head there is an offset marked in the patent, C, which serves to strengthen the rail and which evens up the two sides of the rail so that the fish plates used with the said rail may be alike for both of its sides. The patent says as follows: "The web E extends from the foot D to the angles respectively  
" formed on opposite sides by its union with the offset C and  
" flange A, thus securing a uniform depth of web, proper for  
" the fish-plates to clamp." By disposing the metal in this way in the rail the maximum strength is obtained with the least amount of metal and the metal is so disposed as to produce the most efficient rail that can be produced with the metal used. The patent points out that one of the advantages of the rail section there shown is that substantially equal masses of metal are contained in the head, the flange and foot, and that this disposition of the metal possesses advantages in rolling. The fifth claim refers to a combined tram and T-rail, having a web located relatively to the flange, A, and head, B, as described, and having an offset, C, as shown in the patent located under the head. The claim also says that this structure provides a maximum capacity of outside pocket for, I presume, the ballast. The rail is to be provided, as I understand  
36 the claim, with the base, D, as shown, so that it is adapted as is any T-rail for fish-plating; the foot, D, furnishing a rest for the fish-plates at the lower edge.

There is much in the patent relating to the relationship of the rail and the ballast, which may or may not be true. I am unable to state the facts in this regard as they could only be ascertained by a series of experiments, which I have not made. Turning now to the defendant's rail, I find that this is a com-

bined tram and T-rail of the same character as the rail of the patent, and intended for the same uses. The rail has a head which is substantially the head of the patent, and it has the flange and the offset under the head, as in the patent, with the web and foot all substantially as shown in the patent. The only difference to which attention need be called between the defendant's and complainant's rail lies in the fact that in the defendant's rail the head emerges into the flange at a point nearer the center of the rail, thus bringing the web under the head of the rail, and not directly below the point where the head merges into the flange. I have made two diagrams, one of the defendant's rail and the other of the rail of the patent, both being in cross-section, and I have divided this diagram up into five divisions each way, using the extreme dimensions of the rail in both directions as a basis. This leaves two diagrams divided in small parallelograms, each containing a portion of the rail section. Now, by comparing the respective squares which occupy a like portion in the diagrams, it will be seen at a glance that the rails are of almost identically the same section, with the one exception that I pointed out, to wit, that in the defendant's rail the head has been carried slightly to the right and the web has been carried slightly to the left.

37 The defendant's rail possesses all the advantages of the rail of the patent. It is adapted to be placed on a sleeper below the street level so that the paving can be brought up to it; it has a head for the bearing of the wheel, a flange which permits ordinary street traffic, a vertical web and foot, and an offset under the head for giving strength to the rail and which offset makes the two sides of the rail alike, so that fish-plates of the same size can be used. The defendant's rail also has the same maximum capacity of outside pocket as has the defendant's rail, and though the force of the particular advantage does not impress me, the defendant's rail, nevertheless, contains it. I do not think that the moving of the head and web, relatively, to the extent shown, makes any substantial or material difference. In my opinion the defendant's rail, as illustrated by the exhibits before me, is a rail containing the construction of parts specified in the fifth claim of the patent in suit. Complainant's counsel offers in evidence the diagram and requests the examiner to mark the same "Comp'ts Ex. Brevoort Diagram."

Q. 6. Please look at the section of rail which I now show you and state whether the said rail structure is similar or dissimilar to the structure set out in the patent in suit and the rail Comp'ts Ex. E, and Comp'ts Ex. "Section Defendant's Rail."

A. I have examined the rail shown me. The said rail has not got the same disposition of metal or the same combination

of parts claimed in the fifth claim of the patent. It is true that the sample of rail shown me has a head, a flange, a web and a foot, but these parts are differently shaped and are differently located in regard one to the—when compared with either the defendant's or complainant's rail. The rail shown me has no offset under the head, and if such a rail was used with fish-plates, one set of fish-plates would have to be used for the side of the rail on which the head was turned and another narrower set of fish-plates would have to be used for that side of the rail on which the flange is turned. Both in the defendant's and complainant's rail, the offset under the head enables fish-plates of like size to be used on both sides of the rail besides furnishing strength to the head. In the sample of rail shown me, strength for the head has been obtained by a different disposition of the metal and the offset has been dispensed with; I think the sample shown me is clearly a different rail from the one described in the patent and specifically claimed in the fifth claim thereof, and likewise I think it is substantially a different rail from complainant's or defendant's rail here before me.

The section of rail referred to in witness last answer is offered in evidence and same is marked "Section California Street Rail."

It is admitted by counsel on both sides that the exhibit just marked "Section California Street Rail," correctly illustrates the rail set out in the answer under California St. Railroad prior use and prior patents Nos. 262,126 and 247,781.

Cross-examination by MR. WHEATON.

X.-Q. 7. Why in your direct examination have you quoted claim five of the patent and have not quoted any of the other claims?

A. My attention was only called by the question to the fifth claim and consequently I did not consider any other.

X.-Q. 8. In the patented rail is there any part of the head that is over the web in vertical line?

A. No.

X.-Q. 9. In the defendant's rail is the head in vertical line over the web or not?

A. The head is over the web.

X.-Q. 10. Then in the respect referred to in the last two questions, is the relative location of the head and web the same in the defendant's rail as it is in the patented rail?

A. It is not.

X.-Q. 11. In the patented rail is the flange in a vertical line over the web?

A. Yes.

X.-Q. 12. In the defendant's rail is the flange in a vertical line over the web?

A. No.

X.-Q. 13. Then in this respect, is the relative location between the web and the flange the same in defendant's rail as it is in the patented rail?

A. No.

X.-Q. 14. Please describe what a tram-rail is as commonly understood?

A. It is a flat rail having a head and flange and no web, and is adapted for being laid on longitudinal stringers; the bottom of the rail is flat.

X.-Q. 15. How long to your knowledge has the ordinary T-rail been in use in combination with fish-plates on ordinary steam railroads?

40 A. I don't know the date exactly. It must be about twenty years ago, perhaps more.

X.-Q. 16. How does the form of the web and the projections from it on both sides, both at its upper and lower ends of the rail of the patent in suit, compare with the form of the web and the projections from it both at its upper and lower ends, commonly used in the old ordinary T-rails referred to?

A. The old ordinary T-rails had webs that merged into the head and foot by curves of small radii just as in the patent in suit but in such rails the head was symmetrical on both sides and there was no offset like C, and no flange like A.

X.-Q. 17. Is there any difference between the form of the fish-plates mentioned in the patent and the form of the web to which they are to be attached shown in the patent, or in the method of attaching such fish-plates to such web from the form of the fish-plates and webs and methods of attaching them together which were in common use on ordinary steam railroads. If so, please describe in what such difference or differences consist?

A. There are no differences.

X.-Q. 18. Are there any differences between the head and flange of the rail shown in the patent and the head and flange of some of the tram-rails which were in public use long prior to 1880. I refer to the top surface of the patented rail only?

A. I have no special rail in mind, but I dare say that old tram-rails could be found whose top surface would be the same.

X.-Q. 19. In view of the fact that the old California street rail had a web and foot attached to a head and flange which, as to its upper service might have corresponded with some of the forms of the upper surfaces of ancient tram-rails, and in  
41 view of the further fact that the use of rails in which the webs were alike upon both sides and with which

fish-plates precisely alike were used upon both sides were common on steam railroads. Will you please describe if you can, how there could possibly be any invention in attaching such webs and fish-plates to any other tram-rail having a somewhat different shape and form to its upper surface?

A. I do not think that the invention consisted in the application of fish-plates to the rail of the patent. The invention consisted of the general conformation of the rail having the head, the flange and offset, the whole forming with its web and foot a very desirable form of rail, and one of the advantages of the form is that it admits of even fish-plating on both sides, while a strong and rigid rail is got with a minimum of metal or rather with the metal located in the best possible way.

X.-Q. 20. Will you please attach a section of fish-plates to the exhibit marked Complainant's Exhibit Section of Defendant's Rail so as to show the connection of the fish-plates and rail?

A. I have made the attachment to said exhibit.

HENRY L. BREVOORT.

Sworn and subscribed to before me this 29th day of April, 1890.

[SEAL.]

ROBERT GRIER MONROE,  
*Notary Public,*  
*New York Co.*

*Certificate to Deposition.*

42 STATE OF NEW YORK, }  
*City and County of New York,* } ss.

I, Robert Grier Monroe, a Notary Public in and for the City and County of New York, State of New York, do hereby certify that the foregoing deposition of Henry L. Brevoort was taken before me on behalf of the Johnson Company, the complainant in two civil causes in the Circuit Court of the United States for the Northern District of California, on the equity side of said Court, wherein the Johnson Company is complainant and the Sutter Street Railway Company and the Pacific Rolling Mills Company respectively defendants, in actions for infringement of a patent; that said deposition was taken in pursuance of notice; that the reason for taking said deposition was and is, and the fact was and is, that said deponent lives at a greater distance from San Francisco, the place of trial of the said actions, than one hundred miles, to wit: In the City of New York, State of New York; that said deposition was taken at my office, No. 140 Nassau street, in the City and County of New York, on the 29th day of April, 1890; that said deponent was by me duly cautioned and sworn to testify the whole truth before the

commencement of his testimony; that the testimony of said witness was reduced to writing by me and by no other person, and that said witness subscribed his testimony after it had been so reduced to writing; that the complainant was represented by George J. Harding, Esq., of counsel, and the respondents by M. A. Wheaton, Esq., of counsel; that the entire testimony

was commenced and concluded on the same day, to wit:  
43 On the 29th day of April, 1890.

In testimony whereof, I have hereunto set my hand and affixed my seal of office at the city of New York, County and State of New York, this 5th day of May, 1890.

[SEAL.]

ROBERT GRIER MONROE,  
*Notary Public N. Y. Co.*

(Endorsed:) Depositions opened by consent, Aug. 27, 1890. G. J. Harding for Complainant, M. A. Wheaton, for Respondents. Opened by agreement and re-filed August 27, 1890. L. S. B. Sawyer, Clerk, by F. D. Monckton, Deputy Clerk.

44 *Exhibit "Drawing of Complainant's Exhibit E."*

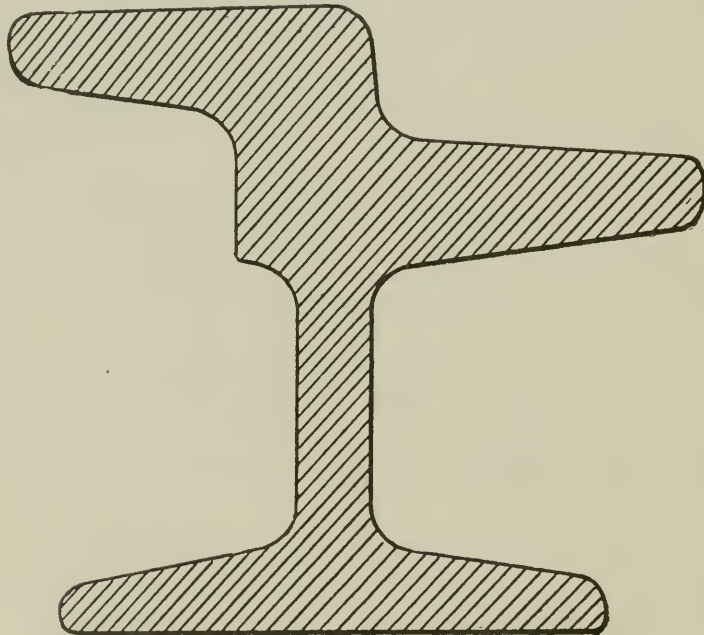

I certify that the above is a true and correct tracing of a drawing introduced in evidence and marked "Complainant's Exhibit E," in the case of the *Johnson Company vs. Sutter Street Railway Company*, in the U. S. Circuit Court for the Northern District of California.

(Signed)

S. C. HOUGHTON,  
*Examiner in Chancery of said Court.*

(Endorsed:) Opened by agreement and re-filed August 27, 1890. L. S. B. Sawyer, Clerk. By F. D. Monckton, Deputy Clerk.

45

*Complainant's Exhibit Brevoort Diagram.*

Defendant's Rail, Figure 1.

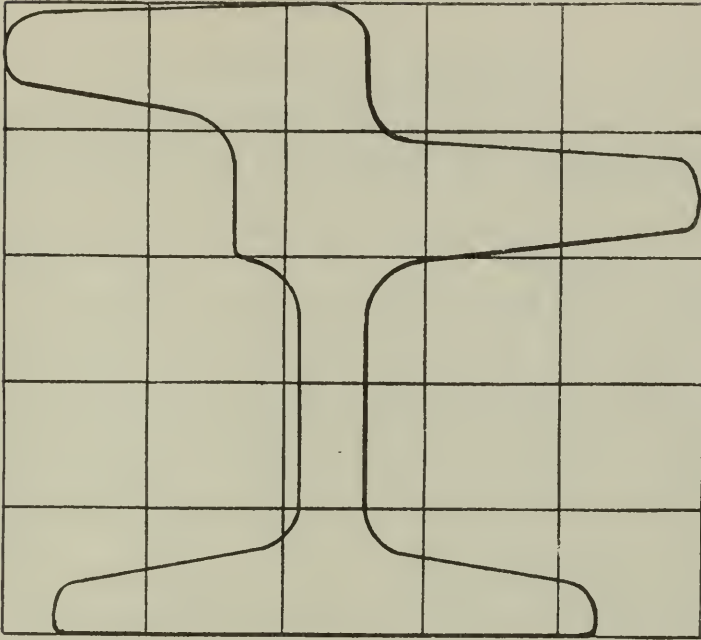

Patented Rail, Figure 2.

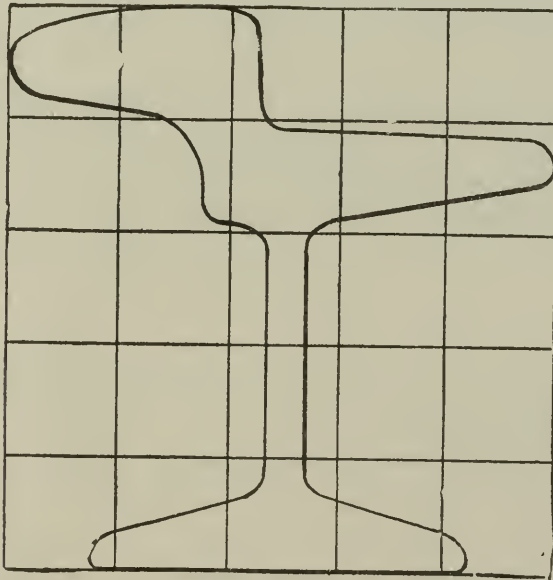

U. S. Circuit Court, N. D. of California.

JOHNSON Co. }  
 vs. } No. 10,394.  
 SUTTER ST. RY. Co. }

JOHNSON Co., }  
 vs. } No. 10,393.  
 PACIFIC ROLLING MILLS Co. }

*Complainant's Ex. Brevoort Diagram.*

R. G. MONROE, *Exr.*, April 29, 1890.

(Endorsed:) Opened by agreement and re-filed August 27, 1890. L. S. B. Sawyer, Clerk. By F. D. Monekton, Deputy Clerk.

46

*Caption to Deposition.*

In the Circuit Court of the United States for the Ninth Judicial Circuit in and for the Northern District of California.

THE JOHNSON COMPANY, Complainant,	}	In Equity. No. 10,393.
<i>vs.</i>		
PACIFIC ROLLING MILLS COMPANY, Respondent.		

Be it remembered, that, on the seventh day of November, A. D. 1889, and on the several days thereafter to which the examination was regularly adjourned, as hereinafter set forth, at my office, room 57, in the United States Appraisers' Building, on the northeast corner of Washington and Sansome streets, in the City and County of San Francisco, State of California, before me, S. C. Houghton, Examiner in Chancery, of the Circuit Court of the United States for the Ninth Circuit and Northern District of California, personally appeared the several witnesses whose names are hereinafter set forth, who were produced and examined on behalf of the respective parties to the above entitled cause.

W. F. Booth, Esq., and G. J. Harding, Esq., appeared as counsel on behalf of complainant, and M. A. Wheaton, Esq., as counsel on behalf of respondent.

Following is a record of the proceedings:

47

*Deposition.*

THURSDAY, *November 7th*, 1889.

Present: Mr. Booth, of counsel for complainant; Mr. Wheaton, of counsel for respondent.

(Complainant introduces in evidence copy, duly certified by the United States Commissioner of Patents, of United States Letters Patent No. 272,554, granted February 20th, 1883, to Tom L. Johnson, for improvement in street railroad rail. Marked "Complainant's Exhibit A.")

(Complainant also introduces in evidence like certified copy of assignment, dated the ninth day of \_\_\_\_\_, 1883, conveying all rights under the patent "Exhibit A" from Tom L. Johnson, the patentee, to Johnson Steel Street Rail Company. Marked "Complainant's Exhibit B.")

(Complainant also introduces in evidence copy, certified by the Clerk of the Jefferson County Court, Kentucky, of the articles of incorporation of the Johnson Steel Street Rail Company, a corporation organized under and by virtue of the laws



of Kentucky, and also of the amendments to said articles of incorporation whereby the name of said corporation is changed to that of "The Johnson Company." Marked "Complainant's Exhibit C.")

(Complainant also introduces in evidence section of street rail. Marked "Complainant's Exhibit D.")

(Complainant also introduces in evidence sectional drawing representing the rail "Exhibit D." Marked "Complainant's Exhibit E.")

(It is admitted as a fact by both complainant and respondent herein, that the Pacific Rolling Mills Company, respondent herein, manufactured and sold at its mills, in the City and County of San Francisco, State of California, after the 20th day of February, 1883, and before the 4th day of June, 1889, the date of the commencement of this suit, the railway rails like that shown by the rail section and sectional drawing thereof, Complainant's Exhibits "D" and "E," respectively.)

(Examination continued, in conformity with agreement of counsel for the respective parties herein, subject to agreement and notice.)

49

SATURDAY, *August 23d*, 1890.

Present: Mr. G. J. Harding, of Counsel for Complainant.

This day was set apart for taking testimony herein, at the request of counsel for complainant.

No counsel on the part of respondent, and no witness appearing, the examination is continued at the request of counsel for complainant until Monday, August 25, 1890, at half past ten o'clock, A. M.

MONDAY, *August 25*, 1890.

Present: Mr. G. J. Harding, of Counsel for Complainant.

(Examination further continued, in conformity with agreement of counsel, until Tuesday, August 26, 1890, at half past ten o'clock A. M.)

TUESDAY, *August 26*, 1890.

Present: Mr. G. J. Harding and Mr. Booth, of Counsel for Complainant, Mr. Wheaton, of Counsel for Respondent.

(Examination further continued, in conformity with agreement of counsel, until Wednesday, August 27, 1890, at two o'clock P. M.)

WEDNESDAY, *August 27*, 1890.

Present: Mr. Harding and Mr. Booth, of Counsel for Complainant, Mr. Wheaton, of Counsel for Respondent.

Examination-in-chief of PATRICK NOBLE, on behalf of respondents.

By Mr. WHEATON:

Q. 1. State your name, age, place of residence and occupation.

A. My name is Patrick Noble, my age forty-one years. I reside in San Francisco, and am by occupation Superintendent of the Pacific Rolling Mills.

Q. 2. Have you read the specification and drawings of the complainants' patent sued on in this case, and do you understand them?

A. I have read them, and understand them.

Q. 3. How many of the cable street-railroads in this city have used girder rails with the web and foot of the ordinary T-rails?

A. I think all—all, except the Clay Street and Sutter Street up to this time. The Sutter Street now uses it; so I think the Clay Street is the only one—No, there are three roads that do not use them: the Clay Street, the Geary Street, and the Union Street.

Q. 4. What kind of a rail was put on the Clay Street road when it was first built?

A. Well, it was a T-rail-girder rail.

Q. 5. What was the difference between that rail, as to shape, and the ordinary T-rail.

A. Of which, the Clay Street?

Q. 6. Yes.

A. It was an ordinary T-rail.

Q. 7. Now listen to the question I asked you a moment ago, as to how many of the cable street roads use girder rails with the web and foot of an ordinary T-rail, and see whether  
51 you understood it.

(Q. 3 repeated.)

A. My answer was, all except three. Now, you want me to enumerate them?

Q. 8. No. I cannot understand why you make an exception of the Clay street road?

A. I ought not to have done so in the case of the Clay Street Railroad. I had my mind on the patent rail. It was a girder rail that was used. I should have said that all the cable roads in this city, except two, used such rails, those two being the Union street and the Geary street roads.

Q. 9. Which was the first cable road built here?

A. The Clay street.

Q. 10. When was that built?

A. Well, I don't remember exactly. It was somewhere about 1877.

Q. 11. Wasn't it set running in 1873?

A. No, I don't think so. I don't know. I don't recollect.

Q. 12. Which was the next cable road built after the Clay street, in this city?

A. My recollection is that it was the California street road. I am not exactly certain, but it was either the California street or Sutter street. I think the California street was prior.

(The following are admitted as facts in this case by both complainant and respondent, namely:

That the Clay Street Cable Road commenced operating in San Francisco in the year 1873.

52 That the Sutter Street Cable Road commenced operating in 1876;

That the California Street Cable Road commenced operating in San Francisco in 1878;

That the Geary Street Cable Road commenced operating in San Francisco in 1880.)

Q. 13. Please look at this section of the defendant's rail, "Exhibit D," and state what the differences are, if any, between that rail and the rail shown in the patent sued upon?

A. This "Exhibit D" has a straight bearing for the wheel, and we avoid, as a disadvantage, the curve which the complainant claims in his patent is an advantage.

Q. 14. Does your last answer refer to the curve on the top of the head of the rail on which the tread of the wheel runs?

A. Yes, sir.

Q. 15. Please explain why you consider that curve shown in the patent to be a disadvantage?

A. A street railroad in San Francisco would not accept of a rail of that construction, because it would wear out the wheels too fast, and also the rail.

Q. 16. How much surface for the head of the wheel that would be practically level do the railroads require for the tread of the wheel to run on?

A. From an inch and three-quarters to two inches, in this city. The complainant's rail is about half an inch.

Q. 17. Half an inch of what?

A. The bearing for the wheel. That would not be salable in this city—that is, so far as the head is concerned.

Q. 18. Has there ever any rail been used in this city, or  
53 made by your company, having the curvature on the surface of the head which is shown in the patent?

A. No. Every rail of the girder shape has to have a slight taper in order to clear the roll—come out of the groove

in the rail. But we make the top of the head of the rail as nearly straight across as mechanical difficulties will permit in rolling. This rail is rolled upon its side, and in rolling the head of the rail, if it was absolutely straight it would not clear the roll, and we make it as nearly straight as possible in order to clear the roll, and avoid the complainant's curve, which we think to be a defect.

The next point of difference is that we make the head of the rail as much over the web as possible, in order to make the rail a balanced rail. The complainant's rail, with the head outside the center line, is directly opposite to what he claims—an unbalanced rail. We so construct a rail as to put the weight of the car on the center line, and the complainant throws it back, giving it a tendency to spread the tracks. I think those are the two most prominent differences in the rails. We have, in fact, adopted his dotted line for the head of the rail, which he is avoiding. He, in his claims, claims that the dotted line is not a good section, and so, in order to get his patent, he adopts the black line. Now, we adopt the dotted lines on our section, nearly, without needing anything about this patent at all. It is simply a question of mechanics.

Q. 19. In your last answer do you refer to the lines in "Fig. 4" of the patent?

A. Yes, sir. As to the dotted line below the head, he claims that he changes it from the "j L g" line to the "j h g" line, in order to give a better pocket for sand, gravel, or macadam, affording a backing to his rail; and that shape  
54 never was made that I know of. We never made it.

Q. 20. Which shape was never made?

A. The shape represented by the "j L g" line. H assumes a deceptive which has never been used.

Now, in reference to the offset "C," he claims that by using that offset he affords a greater pocket capacity for the packing of sand, macadam or gravel. We put it on ours simply to make the two fish-plates equal. As a pocket to receive sand, gravel or macadam, it is a defect, it is an obstruction to the packing as it comes in. If the curve "j h" were continued around in a true curve it would afford a better pocket. So, in that respect, we look upon that offset "C" as a defect.

I will make another statement here, from what I see in the claims of the patent. He claims that the making of this rail in this peculiar shape, the combination of the head "B," the flange "A," and the foot "D"—that he distributes his metal in such a way as to do away with the necessity of cambering or curving while it is hot, during rolling. In our rail we have it put at four or five inches to the camber or curve because the distribution of the metal in our rail makes the foot cool faster

than the head, and it is necessary while it is hot to bring it on a curve with the foot, on the inside of the curve, so that the head cooling slower and later, it draws it straight almost. Now, the cambering is simply a part of the process of straightening the rail, and only a part. It is easier while the rail is hot to put the cambering in, and the cooling brings it to a straight line. The balance of the process is carried out when it is cold.

55 Q. 21. The balance of the process of straightening?

A. Yes. The cambering is part of the process of straightening. In the specification of the patent it says: "All necessity of cambering in the rolling of said rail is therefore obviated, and if the rail be delivered straight and true from the rolls, then it will remain perfectly straight and uncurved when cold." Well, I know that we have never, and I don't think any mill in the world has ever delivered a rail to put down on a surface. It has got to go through the process of straightening, either when hot or when cold. We do part of ours when hot and part of it when it is cold. This rail marked "Exhibit D" required more camber than any rail we have ever made; so that in that respect complainant's claim does not touch us at all.

Referring to the arrangement set out in Claim 5 of the patent, we arrange the relative position of head, flange and web entirely different from the patentee. To go back to this claim: "Another peculiarity of this rail is that the head, flange, web and foot are substantially of equal mass of material." This is not making a comparison, but his head, web and flange are not an equal mass of material. The preponderance is with the head and flange. I am calling attention to that in reference to the heating and cooling off, the contraction in cooling. His rail will require cambering also. That is why I call attention to that. The mass of metal above the web is so much greater than the mass below the web that the cooling will not be equal in the complainant's rail; and that is self evident.

Another peculiarity of the figures that he gives is that he connects all the comparisons of the rails that he desires  
56 to patent with an old tram-rail, entirely ignoring the fact that a girder rail had been made years before (referring to Figures "2" and "3" of the patent sued on.) If he had taken the rail made for the California-street road, which was well known when his patent was taken out, and made a comparison there between his form of rail and the form used on the California-street road, these claims he makes would not have been apparent, and especially the one where he uses the back of the rail as a pocket for the sand, gravel and cement,

because the old California-street rail furnishes a better pocket, the offset "C" being an obstruction.

Q. 22. In the defendant's rail is the web located relatively to the flange, "A," and head, "B," as described in the patent?

A. As I have said, no.

Q. 23. In that respect, how does the relative location of the web, head and flange compare in the defendant's rail with the relative location of the web, head and flange in the old California-street rail?

A. They are practically the same. That is, the weight of the car comes directly over the web.

Cross-examination PATRICK NOBLE.

By Mr. HARDING:

X.-Q. 1. What I understand you to say is that your rail is more nearly represented by what is shown in the dotted lines, "d," in "Fig. 4" of the patent sued on. Is that so?

A. Yes; with the exception of the curve on the back side of the head, our head being straight.

57 X.-Q. 2. Now, you are perfectly sure of this? That is, you have tested it beyond that which comes from looking at this "Fig. 4" alone?

A. Having "Exhibit D" and "Fig. 4" of the patent now before me, I see in "Fig. 4" that the dotted line brings the head directly over the web of the rail. In "Exhibit d" it brings it directly over the web of the rail. It is not a matter of opinion, it is before you; and the black lines in "Fig. 4" brings the head back of the web.

X.-Q. 3. That is, what you contend is that in your rail the head is shoved over as shown by the dotted lines in "Fig. 4" of the drawings of the patent?

A. To a certain degree. I do not admit that the dotted line in that figure is exactly like our head.

X.-Q. 4. But beyond that slope it is; is that what you mean?

A. Yes.

X.-Q. 5. That is, if we take "Fig. 2" of the patent, your web has remained fixed while the head portion of the rail has been pushed laterally?

A. I don't know exactly how to express it that way. What I mean is that our web is directly under our head, and that your web is absolutely out from under your head. The difference is very marked.

X.-Q. 6. Yes, but you don't understand my question. Now, take "Fig. 2" of the patent; you mean to say, do you, that

your rail differs from the patented rail in that while the web stands where it is, as exhibited in "Fig. 2," the portion above the web is moved laterally, always excepting, of course, the top line of the head?

58 A. Always excepting that neither the head, the web, or flange, are alike. The fact is that you make me except to the whole thing.

X.-Q. 7. (X.-Q. 6 repeated.)

A. That will conform somewhat to it, but I don't mean to say that it is absolutely so. It will conform to it. Of course, if you move it, taking "Fig. 2" at the letter "R," why you would do away with the offset, and so that wouldn't be so, you see. Your question is not a practical one. The only way to make the question practical is to put our rail down on your rail, and then you will see what the difference is.

X.-Q. 8. Then, as a matter of fact, Mr. Noble, the best way of finding out whatever difference exists between the patented rail and your rail is to put one on the top of the other?

A. I didn't say that. I said if you wanted to make me draw lines I would put one on top of the other, and then I know I would have mine correct. No, I differ with you. The best way is to state that our head is straight, and has not got a backward declination, and that our web is over the head, and yours is not, in either case.

X.-Q. 9. Now, after all, that is the best way to point out the differences, just as you state now?

A. I think so.

X.-Q. 10. There is no use of mixing it up with dotted lines, or anything of that kind. What you stated in your last answer but one is as fair a way for anybody to understand it as any, isn't it; if not, say not?

A. I think that points out the difference exactly. I will say further, that if I wanted to show the difference between these two rails to an untechnical mind I would take the patent  
59 rail here as represented in the patent, of the same weight and all, preserving the same proportions as he has got it. Mine is a heavy rail, and his is a very light one, you see; and I would draw my rail over that in a different colored ink, and that would show the thing to a dot. That is what you ought to have.

X.-Q. 11. That is what I state: the best way to do so is to put one rail, or the drawing of one rail on top of the drawing of the other.

A. Making the weights per yard the same.

X.-Q. 12. Making them even exactly?

A. Yes. If you put "Exhibit D" on "Fig. 2," it misleads you, because there is so much difference in the scale.

X.-Q. 13. Now there is no question but what you have an offset on your rail, is there?

A. At "C." We have an offset at "C," in "Fig. 2."

X.-Q. 14. In your rail?

A. We have an offset corresponding to the offset "C," shown in the patent, but it is for the purpose of making the fish-plates equal, only.

X.-Q. 15. Now, you cannot even fish-plate on this California Street rail, can you?

A. No; we use a fish-plate on it.

X.-Q. 16. And you can even fish-plate on your Sutter Street rail, can't you, which is herein alleged to be an infringement?

A. Yes, sir.

X.-Q. 17. This California Street rail, and the Omnibus rail, that you roll, are the only two flanged or girder rails in use in this city, are they not, with the exception of the rail complained of in this suit?

60 A. Yes. I will make an exception of that, of course. We roll numbers of girder rails, but not for street railroad purposes.

X.-Q. 18. They are not flanged?

A. No, sir.

X.-Q. 19. Well, that question was restricted to "flanged"?

A. No; they are not flanged.

X.-Q. 20. Now, in this rail complained of, you have a head which projects to one side of the web, have you not?

A. Partly.

X.-Q. 21. Well, it projects to one side of the rail, doesn't it?

A. Part of the head does—yes. The whole head don't.

X.-Q. 22. Well, the head extends to one side, beyond the web, doesn't it?

A. Yes, sir.

X.-Q. 23. While it does not extend beyond the web on the other side, does it?

A. Well, it does very slightly.

X.-Q. 24. And you have projecting from the other side of the web a tram or flange?

A. Yes.

X.-Q. 25. And you have a web, have not not?

A. Yes.

X.-Q. 26. And you have an offset corresponding to the offset "C," shown in "Fig. 2" of the patent, have you not?

A. I have.

X.-Q. 27. Suppose that offset were removed from your rail, and the line of the curve of the head were carried to its junction with the web, would there be sufficient metal at the point where the tram or flange meets the head to form a safe and practical rail?



A. Yes; more than yours—thirty per cent. more, I should think.

61 X.-Q. 28. More than ours, with the offset and all.

A. Yours is a half an inch, and mine would be within a fraction of three-quarters of an inch, and that would be nearly fifty per cent. more than yours, having the offset.

X.-Q. 29. Did you take the measurement from the point of the offset?

A. I took it at the narrowest point.

X.-Q. 30. You didn't take it, then, from the point of the offset?

A. I took it where it is narrowest.

X.-Q. 31. I ask you, did you take it from the point "g"?

A. I took it from the point where it is narrowest; from the point where it is weakest.

X.-Q. 32. You took your measurements from the drawing of the patent, when speaking of the patent rail, didn't you?

A. Yes, sir.

X.-Q. 33. You stated that you were connected with the defendant company, didn't you, the Pacific Rolling Mills?

A. I am the superintendent, sir. I am the one that makes those rails.

X.-Q. 34. Look at the patented rail. The offset "C" in that patent enables even fish-plating to be used, doesn't it?

A. Yes, sir.

By Mr. BOOTH:

X.-Q. 35. Mr. Noble, in answer to Mr. Wheaton, upon your examination-in-chief, you referred to the dotted lines represented by the letter "d" in "Fig. 4" of the complainant's patent, and stated that your rail more nearly conformed to the section represented by that dotted line which was the very section which the patent stated to be disadvantageous. I will now ask you whether you referred to the matter from lines 60 to 66, inclusive, on page 2 of the specification of the  
62 patent?

A. No, I stated, if I recollect, in my answer, that I referred to Claim 5. If I didn't say it this way, it is what I intended to state. I intended to state that the web "E," flange "A" and head "B," were diametrically opposed in our rail to the complainant's, and that the principle was more clearly shown by his dotted line "d"—that it carried out our principle more than his. It is not the conformity that I was speaking of, but the principle.

X.-Q. 36. Did you not state that the patent stated that were the head and flange moved over to the position shown by the dotted line "d" it would be a disadvantage?

A. I don't understand your question.

X.-Q. 37. (X.-Q. 36, repeated.)

A. So far as the principle is concerned, I am not saying that I took the section and moved it over.

X.-Q. 38. (X.-Q. 36, repeated.)

A. I think I said so far as the head was concerned. I think you made the distinction. I made the exception that so far as the head was concerned that dotted line more nearly carried out our principle, and which the complainant said was a disadvantage. Of course that was my recollection of what the complainant claimed was a disadvantage. I am certain that I made the exception that it was only the lines on the head.

X.-Q. 39. Well, do you gain your opinion of what the patent states in that regard from line 60 to 66, inclusive, of page 2 of the specification?

A. I couldn't say whether it was or not, without reading over the whole thing.

63 X.-Q. 40. Well, read the lines, if that is the place?

A. Well, I don't know whether that is where I drew my inference from or not, although that does refer to that very thing, and I think it would be an advantage to do just what he has said, looking at his rail entirely—looking at his section.

X.-Q. 41. "To do just what he has said," what do you mean by that? What do you mean by "to do just what he has said?"

A. What he has said between lines 60 and 66, inclusive; throw this head forward at "d" and keep the offset, "C," intact.

X.-Q. 42. Stationary?

A. Yes, sir; I think it would make a stiffer and a preferable rail.

X.-Q. 43. Do you or do you not do that in your rail?

A. We do that.

X.-Q. 44. That is, you mean to say that you throw your head and flange over and keep your offset stationary?

A. Yes; and thereby gain greater strength.

X.-Q. 45. Mr. Noble, I will show you "Complainant's Exhibit Brevoort Diagram," and you will see that "Fig. 1" represents your rail, and "Fig. 2" represents the rail of the patent. They are on different scales, are they not?

A. Yes, sir.

X.-Q. 46. Do you see the object of the squares in which these rails are delineated?

A. I would take it that it was to show the relative position of the head and flange and web.

X.-Q. 46. Now, looking at those two figures, are not the offsets in the same position?

A. No.

X.-Q. 47. How are they in different positions, if so?

64 A. Well, in the center square it comes up above the web in the defendant's rail, in "Fig. 1;" and in "Fig. 2" it comes below the square into the web.

X.-Q. 48. Acknowledging the correctness of this answer, so far as a vertical plane is concerned, let me refer you to a lateral. Are they not in the same position laterally?

A. They are not. In "Fig. 2," in the vertical line of squares, your web is in the middle of the squares. In "Fig. 1," in the defendant's rail, the web is to the left of the center.

X.-Q. 49. I refer to the offset only.

A. It is the same, with reference to the offset.

X.-Q. 50. Is not the point of the offset in "Fig. 1" the same distance from the left-hand line of the diagrammatic squares as the point of the offset in "Fig. 2" is from the same line of its diagrammatic squares?

A. Of course you cannot answer that exactly, because they are not on the same scale; but I should say, no.

X.-Q. 51. Are they not, relatively, the same distance from that line?

A. No; you can't say that. The only way to answer that question is as a claim is made in relation to the three parts.

X.-Q. 52. I am only speaking of the offset.

A. The offset is not the same in both. Now, if we scale it, would it be the same? That is a question I cannot answer. We would have to scale it to find out. You might say so, and I would think not, and we would both be pretty near right. We would have to scale it to see?

65 X.-Q. 53. Mr. Noble, if defendant's rail as represented by "Exhibit D" were reduced to the scale or to the same size as the drawing "Fig. 4" in complainants patent, would the distance from the point of your offset to the junction of head and flange be as great as the distance from the point "g" in "Fig. 4" of complainant's patent to the junction of the head and flange on the dotted line "d"?

A. Well, I couldn't say. We would have to do it to find out. It is one of those things you couldn't tell by your eye. You can't tell that by your eye. It might and it might not be.

X.-Q. 54. Well, what do you think? Give us the best answer you can.

A. Well, that is the best answer I can give, that it might come so, and it might not. I will measure this and see. You see the distance from the point of the offset in "Fig. 4," to the junction of the head and flange, using the dotted line "d," is nine-tenths of an inch, and the distance between the same points on "Exhibit D" is nearly eleven-tenths of an inch, and

from that you can see if this rail were reduced it would reduce that distance, and it would then more nearly approach the distance shown on the patent drawing between those points.

X.-Q. 55. Now, if the reduction in the scale were made, as before intimated, do you not think that, from an observation of the defendant's rail and the drawing, that the distance between the points mentioned in the drawing would be greater than the distance between the points mentioned in the rail so reduced?

A. No, I should not; and I can only argue from sight, and that is very deceptive.

66 Re-examination of PATRICK NOBLE.

By Mr. WHEATON:

R.-Q. 1. Were the girder rails which were used on the Clay Street cable road when it first started here, even fish-plated?

A. Yes, sir.

R.-Q. 2. As the defendant's rails have been laid on the Sutter Street cable road, was there ballast used for pavement which filled in the pockets on each side of the rail between the foot and flanges?

A. No, sir; it was laid in stone and concrete; in concrete on the inside, and stone on the outside—basalt rock.

R.-Q. 3. How were those stone blocks arranged in connection with the rail in the pavement?

A. Set square up to the flange and head of the rail, both front and back. That is one of the features of the girder rail, which is its adaptability for paving.

R.-Q. 4. You mean the advantages of the girder rail, or flange and head, is that you can lay those stone blocks up against them?

A. Yes, sir.

R.-Q. 5. As they are used in practice, do the top of the stone paving blocks come up level to the top rail on the street?

A. Yes, on a level with the head; and some put it on the level of the flange, and some up above, but it is better to have it on a level with the flange.

R.-Q. 6. Was that the way that the rails and paving were laid on the California Street road in 1878?

A. Yes, sir.

By Mr. HARDING:

R.-Q. 7. The rail that you spoke of in use on the Clay Street road is the ordinary T-rail, is it not?

67 A. Yes, sir.

R.-Q. 8. Without flanges projecting from the head at all?

A. No, sir; it had no flanges.  
Mr. Wheaton: Defendant rests.

(It is stipulated and agreed, by and between counsel for the respective parties herein, that the foregoing deposition of the witness Patrick Noble, may be transcribed and used in the case of Johnson Company vs. Sutter Street Railway Company, and be of the same force and effect as if originally taken in said case.)

68

*Certificate to Deposition.*

I certify that the foregoing depositions were taken at the place stated in the caption to said depositions, at the several times set forth in said depositions, in my presence, and in the presence of counsel for the respective parties to the cause in said caption, entitled: that, previous to giving his testimony, each of the witnesses in said depositions named was by me duly sworn to tell the truth, the whole truth and nothing but the truth, in said cause; that said depositions were, except in so far as they were taken down in writing by the Examiner, taken down in shorthand writing and transcribed by A. L. Coombs, pursuant to stipulation and agreement of counsel; that said depositions, after being so transcribed, were read by, or by me to, the said witnesses, and signed by them, respectively, except in those cases where such reading and signing were, by agreement of said counsel, waived, as in said depositions set forth; and that I have retained said depositions for the purpose of delivering the same with my own hand to the Court for which, they were taken.

Accompanying said depositions, and forming part thereof, are the several exhibits introduced in connection therewith, and referred to and specified therein.

I further certify that I am not attorney nor of counsel for any of the parties to said cause, nor in any way interested in the event thereof.

In witness whereof, I have hereunto set my hand, this tenth day of November, A. D. 1890.

S. C. HOUGHTON,  
*Examiner in Chancery,*  
*U. S. Circuit Court, Northern Dist. of Cal.*

(Endorsed:) Testimony opened and re-filed Nov. 20, 1890.  
L. S. B. Sawyer, Clerk.

69 U. S. Circuit Court, N. District of California.

THE JOHNSON CO.

vs.

PACIFIC ROLLING MILLS CO.

} No. 10393.

*Complainant's Exhibit A.*

(Patent Sued on.)

S. C. H., *Examiner.*

DEPARTMENT OF THE INTERIOR.

(Vignette.)

UNITED STATES PATENT OFFICE.

To all persons to whom these presents shall come, greeting:

This is to certify that the annexed is a true copy from the records of this office of the letters patent granted Tom L. Johnson, February 20, 1883, Numbered 272,554, for improvement in street railroad rail.

In testimony whereof, I, C. E. Mitchell, Commissioner of Patents, have caused the seal of the Patent Office to be affixed this 24th day of October, in the year of our Lord one thousand eight hundred and eighty-nine, and of the Independence of the United States the one hundred and fourteenth.

[SEAL.]

C. E. MITCHELL,  
*Commissioner.*

70

No. 272,554.

THE UNITED STATES OF AMERICA.

(Vignette.)

To all to whom these presents shall come:

Whereas, Tom L. Johnson, of Indianapolis, Indiana, has presented to the Commissioner of Patents a petition praying for the grant of letters patent for an alleged new and useful improvement in street-railroad rails, a description of which invention is contained in the specification, of which a copy is hereunto annexed and made a part hereof, and has complied with the various requirements of law in such cases made and provided; and

Whereas, upon due examination made the said claimant is adjudged to be justly entitled to a patent under the law;

Now, therefore, these letters patent are to grant unto the said Tom L. Johnson, his heirs or assigns, for the term of seventeen years from the twentieth day of February, one thousand eight hundred and eighty-three, the exclusive right to



T. L. JOHNSON.

STREET RAILROAD RAIL.

No. 272,554.

Patented Feb. 20, 1883.

Fig. 1.

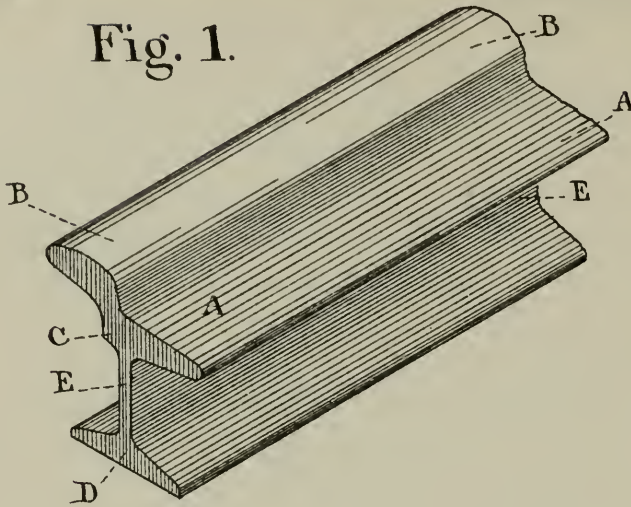

Fig. 2.

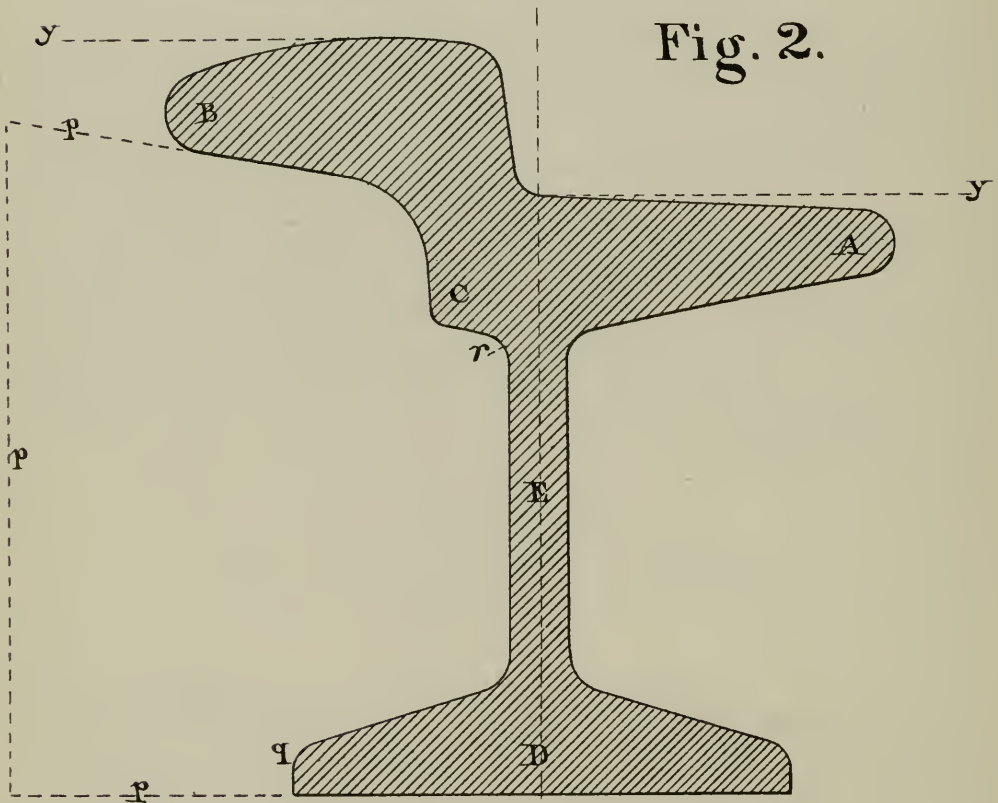
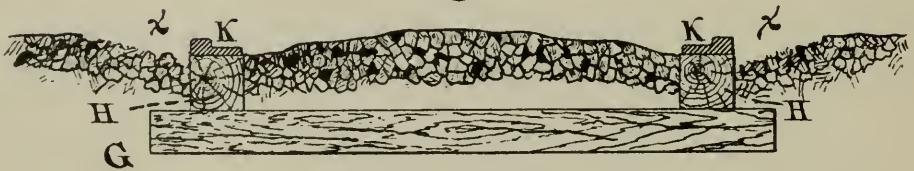

Fig. 3.



Witnesses:  
 Horatio C. King

Inventor  
 Tom. L. Johnson





T. L. JOHNSON.

STREET RAILROAD RAIL.

No. 272,554.

Patented Feb. 20, 1883.

Fig. 4

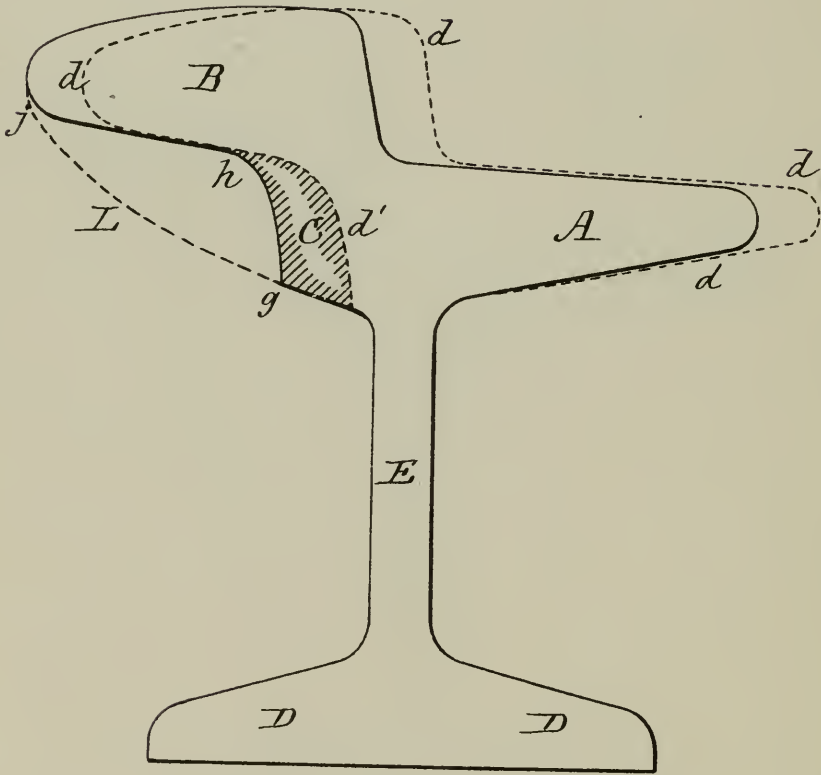

WITNESSES

W. B. Masson

INVENTOR

T. L. Johnson

make, use and vend the said invention throughout the United States and the Territories thereof.

In testimony whereof, I have hereunto set my hand and caused the seal of the Patent Office to be affixed at the City of Washington this twentieth day of February, in the year of our Lord one thousand eight hundred and eighty-three, and of the Independence of the United States of America the one hundred and seventh.

[SEAL.]

71 Countersigned:

M. L. JOSLYN,  
*Acting Secretary of the Interior.*

E. M. MARBLE,  
*Commissioner of Patents.*

UNITED STATES PATENT OFFICE.

Tom L. Johnson, of Indianapolis, Indiana.

*Street-Railroad Rail.*

Specification forming part of Letters Patent No. 272,554, dated February 20, 1883. Application filed September 11, 1882. (No model.)

To all whom it may concern:

Be it known that I, Tom L. Johnson, of the city of Indianapolis, County of Marion, and State of Indiana, have invented certain new and useful improvements in street-railroad rails, of which the following is a specification:

The object of my said invention is to improve the form of that class of railroad rails, used principally by street railroads, which combine the principal features of the tram-rail, ordinarily used for such purposes, and those of the T-rail used on steam-railroads.

I am aware that rails embodying the general features above mentioned are old, and I therefore disclaim the same, and confine myself to the form hereinafter particularly described and claimed as new.

Referring to the accompanying drawings, which are made a part hereof, and on which similar letters of reference indicate similar parts, Figure 1 is a perspective view of a portion of a rail formed in accordance with my invention, and Fig. 2 a transverse vertical section of the same. Fig. 3 shows a section of a street-railway bed and ordinary rails as commonly laid.

In said Figs. 1 and 2 the letter A indicates the flanged portion of the rail; B, the head of the rail; C, an offset under the

head of the rail, abutting the web E, on the side of said web opposite to that continued out into the flange A. The web E extends from the foot D to the angles respectively formed on opposite sides by its union with the offset C and flange A, thus securing a uniform depth of web proper for the fish-plates to clamp.

In Fig. 3 the letter G indicates an ordinary cross-tie, the letters H H stringers, such as are ordinarily used upon street-railways, and K K an ordinary form of street-rail laid thereon. The letters *x x* indicate the edges of the adjacent and underlying roadway.

A peculiar and important feature of this rail is the offset C, which, while serving the purpose of a close fit for the splice-bar or fish-plate, as above mentioned, also serves another equally or more important purpose in the general conformation of and peculiar disposition of metal in the rail.

In the ordinary tram-rail or street-car rail the wear and tear of the street immediately adjoining the rails is an item of serious importance and cost. It is noticeable that after an ordinary track has been laid the street on both outer sides, in particular of the rail, becomes quickly grooved, allowing the water to collect there, by which the timber-work beneath the rails is rapidly rotted and ruined, thus, besides interrupting and annoying ordinary traffic, necessitating loss of time and heavy expense in street repairs. This wear and tear can best be illustrated by referring to Fig. 3. At the points *x x*, on the outer sides of the rails, owing to the lack of some supporting medium for the earth or gravel and ballast surrounding the rail, the street becomes quickly depressed or worn down and grooved. Such a supporting medium, however, actual practice has shown is conspicuously attained by the peculiar form of section given to the rail forming the subject of this invention on both sides, but more particularly on the outer and most important side of the rail.

The splice-bar offset C is a large factor in the proper retaining of this ballast, for it is large enough, with its square corner, in connection with the curved or arched shape of the lower part of the head and T-shaped foot, to allow the surrounding and superincumbent traffic to press the ballast—gravel and stones of the street—into and against the rail, instead of (as shown in Fig. 3) cutting away the surface of the street from the rails. By sweeping out the metal between the dotted line L and the true outline *g h j*, Fig. 4, instead of carrying the curve from the point *g* to the outer edge, *j*, a freer flow of the small stone or the looser ballast is permitted under the head, and a more capacious pocket presented for its reception than would otherwise be the case. The shape of these rails, more-

over, is such that the ballast and earth are retained by them, when so pressed into them, and solidified by the ordinary street traffic. This will be apparent by referring to Fig. 2, in which the dotted outline  $p p p$  may represent a mass of ballast, gravel, or stone, part of the street-bed. Now, the tendency of the wheels running alongside of the track above would be to throw the rail over on a center at about the point  $q$ , for  $q$  being taken as a center and the dotted line  $q r$  as a radius, it will be seen that the offset  $C$ , the lower curve of the same being eccentric to the assumed center at or near  $q$ , will clamp the ballast and hold the rail by reason of such clamping and also by its surface-friction. Consequently the packed earth or ballast will be gripped and retained tight-packed under the head, and between it and the offset and foot of the rail, and thus preserve the location of the rail and maintain intact the gage of the road. This latter point may be further emphasized thus: The general tendency of street-car or of other tracks is to lose their gage by spreading, rather than by closing, of their tracks. This is usually caused by the loosening of the surrounding ballast in the first place, thus taking away a main cause of resistance to the spreading tendency of the street-cars, but still more to that of the vehicles traveling on the track subsequent to such loosening. Hence the firm clamping and retaining of the outside ballast, due to the peculiar shape of this offset, together with the proportion and general shape of the under side of this rail, serves effectively the purpose of retaining the gage of the track. It is, moreover, obvious that, so far as the ballast is concerned, the reverse of this takes place—that is, the same shape and cause that clamps the rail to the ballast will serve to clamp the ballast to the rail—if we consider the rail as the stationary point of resistance, and the ballast, being now considered as a homogeneous block, as free to move over on the assumed center near  $q$ . Thus is effected the double purpose of preserving the integrity of the streets, as well as maintaining the gage of the road intact. The latter is, in fact, consequent upon the former.

Although the municipal regulations of many cities demand that a rail of not less than a given width be used, varying from four to five and a half inches, yet owing to the wear and tear of the street, due to the causes above explained, it has become imperative upon street-railroad companies to lay as wide a rail as possible; but such necessary width can only be obtained, in the rolling of a web and flange rail, by a careful location of the web with reference to the head and to the depth of flange allowed to enter each roll, for the pitch-line of the roll-train should pass through the center of the web. This demand is provided for in this rail, as will appear by reference to Fig. 2,

in which the web is so located that as much of the long flange A is thrown above the pitch-line of the bottom roll as is possible, it being understood that the flange ends and the head commence at the point touched by a line bisecting the curve connecting the head and flange. By this means the greatest facility in rolling is secured compatible with the proper stability of the rail. It will, moreover, be seen that this location of the head relatively to the vertical web secures an important economy in material, for by reference to Fig. 4 it will be seen that if the head, B, of this rail were to be thrown into the position shown by the dotted line  $d d d$  while the shoulder  $g h$  remains stationary it would necessarily increase the total mass of the metal at C to the extent of the mass contained between the outline  $g h$  and the dotted line  $d'$ .

In all ordinary rails, of whatever width, the head and flange are generally straight, or very nearly so, presenting a square corner or step to the wheels of crossing vehicles, and as a consequence the impinging wheels of such vehicles strike solidly on and mount squarely over, if crossing the rail at nearly a right angle, but if at an angle inclined to the track the wheels slide sidewise, raking, scraping and tearing the street, as shown at the points  $x x$ , Fig. 3, whereas in the rail forming the subject of this invention this wear and tear of the street is prevented by the bevel given to both its head, B, and flange, A, as is indicated by their departure from the horizontal dotted lines  $y y$ , Fig. 2; for the wheels of passing vehicles will mount and pass over these rails, particularly on the outer or head side, at any angle, with little or no tendency to slide sidewise; for it will be seen by referring to said figure that the departure of the head of said rail from the horizontal rapidly increases from the point just beyond that which would be covered by the tread of the wheels. This part of the head is, in fact, an addition to the head proper, by which addition the extreme point of the bevel is thrown below the grade of the surrounding street, thus providing for the subsequent settling of the same. This conformation of rail would be impossible if the width of head were equal or only slightly wider than the tread of the wheels. Another peculiarity of this rail is that the head, flange, web and foot are substantially of equal mass of material. In rolling iron of peculiar shape there are generally well-defined points which determine the subsequent contraction of said shape during cooling. These points may safely be defined, in a general way, as being the extremely-exposed points of the given shape. It is an object gained in the manufacture of these shapes if the relation of these exposed points one to the other is such that the respective masses, taken together with their distance from the natural neutral axis of said shape, shall

the one neutralize the other in their contraction during cooling, and thus preserve a rolled bar of given shape free from distortion when cold. Thus star-iron, whose four arms are generally of equal section, remains free from distortion during cooling. In angle-iron, on the contrary, where there are three determining-points of contraction, the greater mass of metal in that one point forming the angle causes an excess of contraction at said point, and consequently curves and distorts the bar during cooling. So in the ordinary **T** and tram rail, the greater mass of metal in the head determines in a similar way excess of contraction at that point. It is, however, consistent with the above law to have a greater mass of metal in one part than in another, provided such excess of metal be not located in one of the determining-points of contraction, but rather situated at or near what may be defined as the neutral axis of contraction.

It will be seen that were the head of the rail forming the subject of this invention constructed as is ordinarily the case such construction would throw an excess of mass of metal into one of the determining-points of contraction of said rail, by which means the rail would become, as is ordinarily the case, distorted or curved in cooling. To avoid this it will be observed that the under part of the head in said rail is cut away, by which means the mass of metal at the determining-points of contraction, taken together with the respective distances of said points from the neutral axis, is such that the rail is not distorted or curved during cooling, and at the same time there is secured a lighter and equally efficient rail.

In ordinary rails the object has been to secure the longest wear by putting a maximum amount of metal in the head—the part most subject to wear—and a minimum of metal in the other parts. The effect of such construction is that in rolling the rail, when it leaves the rolls its thin parts are cooler than its thick parts, and the thicker parts, having most material, naturally retain the heat a longer time. Now, if such rail be delivered from the rolls straight and true, but with the above-mentioned difference of temperature in its several parts, that part having the higher temperature will shrink in cooling more than the thinner and cooler parts, in consequence of which unequal shrinkage the rail, when cold, will be bent and curved, even if it had been delivered straight. In practice, to counteract this curvature in cooling, it is customary, upon the delivery of such rails from the rolls, to give them a “camber” or reverse curve, so that in cooling the rail will tend by curving in the opposite direction to straighten itself. This means, owing to the variable conditions of temperature in the different rails, can only give approximate results. Now, owing to the

substantially equal mass in head, web, flange and foot of the rail, as hereinbefore described, together with their respective location from the neutral axis, the effect of temperature in the several parts is substantially uniform upon said parts. All necessity of cambering in the rolling of said rail is therefore obviated, and if the rail be delivered straight and true from the rolls, then it will remain perfectly straight and uncurved when cold.

It will also be observed that this construction of rail permits of the under side of the head being made concave, which construction secures a larger pocket for the retention of the ballast, and a contour permitting of the more easy inflow of the adjacent ballast, as hereinbefore described, than if the under side of the head were either convex or approximately square, as is generally the case.

It is of importance to bear in mind the fact that this rail is designed for the purpose of supporting the car by the tread of the wheels and not by their flanges, as is sometimes practiced.

Having thus fully described the form, uses and advantages of my said rail, as of my invention, I claim—

1. The combined tram and **T** rail described, in which the head *b* is constructed of a proper width to prevent the car wheels from coming in contact with the paving, and inclined from near its inner to its outer side, so that the weight of the car shall be at all times upon that portion of said head which is nearly directly above the web of said rail, substantially as shown and specified.

2. A combined tram and **T** rail having the head B, located with reference to the center line of the web, re-enforced, as at C, and proportioned with reference to the flange A and the remaining parts of the rail, substantially as described, whereby the metal is distributed in the several parts, so as to equalize contraction therein during the process of cooling, substantially as set forth.

3. The combined tram and **T** rail described, the width of whose head is proportioned and the lower part of its head curved and offset, substantially as shown and described, so as to allow the superincumbent pressure of ordinary adjacent street traffic to force the surrounding ballast into and against, instead of from, the rail, and to solidify and retain the ballast forced against and held by said rail, thus preserving the adjacent road-bed and maintaining an accurate gage of track, substantially as set forth.

4. In the combined tram and **T** rail described, the web E, located relatively to the flange A and head B, as described, so that a large part of the flange A is thrown above the pitch-line



of the bottom roll used in its manufacture, whereby, in rolling, increased facility and economy of manufacture are secured, substantially as set forth.

5. In the combined tram and **T** rail described, the web E, located relatively to the flange A and head B, offset at C, as described, whereby a maximum capacity of outside pocket is secured with a minimum quantity of metal consistent with the proper stability of the rail, substantially as set forth.

6. A combined tram and **T** rail having a reverse beveled or arched head, B, the outer bevel of which is prolonged and terminates in a rapidly-descending curve, by which conformation the extreme point of said curve is thrown below the grade of the surrounding street and the settling of the street provided for, and whereby great facility is afforded for vehicles to mount over and run across said rails, and wear and tear of road-bed or ballast adjacent thereto obviated or greatly diminished, substantially as set forth.

In witness whereof I have hereunto set my hand and seal, at Indianapolis, Indiana, this 9th day of September, A. D. 1882.

TOM. L. JOHNSON. [L. s.]

In presence of

C. BRADFORD,

E. W. BRADFORD.

(Endorsed:) Opened and re-filed Nov. 20, 1890. L. S. B. Sawyer, Clerk.

72 *Complainant's Exhibit B.*

U. S. Circuit Court, N. Dist. of Cal.

THE JOHNSON COMPANY

vs.

PACIFIC ROLLING MILLS CO.

} No. 10,373.

*Complainant's Exhibit B. (Assignment of Pat. Ex. A, to Johnson Steel Street Rail Co.)*

S. C. H., *Examiner.*

DEPARTMENT OF THE INTERIOR.

UNITED STATES PATENT OFFICE.

To all persons to whom these presents shall come, Greeting:  
This is to certify that the annexed is a true copy from the records of this office of an instrument of writing, executed by Tom L. Johnson, 9th day of \_\_\_\_\_, 1883, and recorded in Liber R, 29, page 184. Said record has been carefully compared with the original, and is a correct transcript of the whole thereof.

In testimony whereof, I, C. E. Mitchell, Commissioner of Patents, have caused the seal of the Patent Office to be affixed this 29th day of October, in the year of our Lord one thousand eight hundred and eighty-nine, and of the Independence of the United States the one hundred and fourteenth.

[SEAL.]

C. E. MITCHELL,  
*Commissioner.*

Liber R, 29, P. 184.

Whereas I, Tom L. Johnson, of the city of Indianapolis, State of Indiana, have invented a certain new and useful improvement in railroad rails, for which Letters Patent for the U. S., Numbered 272,554, were issued to me on the 20th day of February, 1883; and,

Whereas, by a contract dated the 6th day of February, 1883, I did agree with J. V. Johnston, E. C. Moxham and A. I. Moxham, all of the city of Louisville, State of Kentucky, to form, under the laws of the State of Kentucky, a corporation, to be known as the Johnson Steel Street Rail Company; and,

Whereas, by said contract, I conveyed to the said J. V. Johnston, E. C. Moxham and A. I. Moxham, a one-half interest in said letters patent; and,

Whereas, it was agreed between the said parties to the said contract, that the said letters patent should be transferred, assigned and conveyed to the said corporation when formed; and, whereas, the said corporation, the Johnson Steel Street Rail Company has been duly created under the laws of said State; and,

Whereas I, and the said J. V. Johnston, E. C. Moxham and A. J. Moxham, have each of us subscribed to the stock of the said corporation, and have assigned and transferred to said corporation, in part payment of the stock taken by each of us, the interest owned by each of us in the said letters patent: now therefore, in consideration of the premises, and one dollar and other valuable considerations to me paid, the receipt whereof is here acknowledged:

I, the said Tom L. Johnson do hereby sell, assign and transfer unto the said the Johnson Steel Street Rail Company the whole right, title and interest in and to the said invention or improvement in railroad rails, patent for which No. 272,554 was issued to me on the 20th day of February, 1883, as described, for the said company's own use, and for the use of the said company's legal representatives.

74 In testimony whereof I have hereunto set my hand and affixed my seal this 9 day of \_\_\_\_\_, 1883.

TOM L. JOHNSON.

In presence of

H. L. CROSS,  
GEO. WILSON.

Recorded April 30, 1883.

EDELL, J. B. B.

(Endorsed:) Opened and refiled Nov. 20, 1890. L. S. B. Sawyer, Clerk.

75 *Complainant's Exhibit C.*

U. S. Circuit Court, N. Dist. of Cal.

THE JOHNSON Co.	}	No. 10,393.
vs.		
PACIFIC ROLLING MILLS Co.		

*Complainant's Exhibit C. (Articles of Incorporation of Johnson Steel Street Rail Co.)*

S. C. H., *Examiner.*

Articles of Incorporation of the Johnson Steel Street Rail Company:

Know all men, that we, Tom L. Johnson, A. J. Moxham, J. V. Johnston, and E. C. Moxham, do hereby associate ourselves together and become incorporated under the name of the "Johnson Steel Street Rail Company" under the provisions of Chapter Fifty-six of the General Statutes, claiming the general powers granted under said chapter, to wit: To have perpetual succession; to sue and be sued by the corporate name; to have a common seal; and alter the same at pleasure; to render the shares or interests of stockholders transferable, and to prescribe the mode of making such transfer; to exempt the private property of members from liability for corporate debts; to make contracts, acquire and transfer property, possessing the same power in such respects as private individuals now enjoy; to establish by-laws, and make all rules and regulations deemed expedient for the management of said corporation or its affairs not inconsistent with the constitution or laws of this State or of the United States.

It is further specially understood and prescribed:

1. That the principal place of business of said corporation shall be Louisville, Ky.

2. That the business of said corporation shall be to develop the use and sale of the rail patented and known as the "Johnston Street Railroad Rail," to grant license to other persons to manufacture said rail under the patents relating thereto, which are now or may hereafter be owned by said corporation to manufacture and sell said rail; to procure the manufacture of said rail by other persons; and to manufacture and sell and deal in all materials used in laying street railroad rails; said corporation to pursue any or all the above mentioned objects of business as it may hereafter determine.

76

3. That the capital stock of said corporation shall be twenty-five thousand dollars, to be divided into two hundred and fifty shares of one hundred dollars each, of which twenty-one thousand dollars shall be paid in money or property on or before the 14th day of March, 1883, the property to be transferred to said corporation in payment of the stock thereof, to be accepted at the valuation of its directors; and the remaining four thousand dollars of said capital stock to be paid when the necessities of said corporation shall require, at such times and in such manner as the Board of Directors shall prescribe by resolution or by-laws.

The capital stock may be increased from time to time by change of these articles in accordance with Chapter Fifty-six, but no increase shall at any time be made except upon a vote favoring such increase of a majority of the stock then issued and paid up, nor unless the same be taken at par and paid for in cash, or its *bona fide* equivalent. In the event the capital stock shall be increased at any time the then stockholders shall have the right to subscribe, pay for and take the additional issue of stock in the same proposition as they may hold paid up stock at the time of such increase. In no event shall any stockholder be compelled to subscribe and pay for any stock directed to be issued as increased capital stock by the persons or person holding a majority of the stock.

If at any time when an increase of capital stock shall have been agreed on as prescribed herein, one or more of the stockholders shall decline to subscribe for any portion of the issue  
77 of increased stock, the remaining stockholder, if there be but one, shall have the right to take the whole of the increased issue, or if there be more than one, the remaining stockholders shall have the right to take the increased issue in the proportion which their holdings of paid up stock bears one to the other.

4. The time of the commencement of said corporation shall be the seventh day of March, 1883, and the time of its termination shall be at the expiration of the twenty-five years next thereafter ensuing.

5. The affairs of said corporation shall be conducted by a Board of two Directors, one of whom shall be President, and one Secretary, as may be determined upon between them; to be elected on the second Monday in March, 1883, and annually thereafter. A unanimous vote shall be necessary for the decision of all questions acted upon by said Directors. A. J. Moxham and Tom L. Johnson shall constitute the first Board of Directors, and shall serve until their successors elected.

6. Said corporation shall at no time subject itself to greater indebtedness or liability than five thousand dollars.

7. The private property of the stockholders shall not be liable to the debts of the corporation.

Witness our hands this 23rd day of February, 1883.

J. V. JOHNSTON,  
EDGAR C. MOXHAM,  
A. J. MOXHAM,  
TOM L. JOHNSON.

78 STATE OF PENNSYLVANIA, }  
County of Cambria. }

This is to certify that on this day personally appeared before me, a Notary Public, in and for the county and State aforesaid, the above named A. J. Moxham, who signed the foregoing Articles of Incorporation in my presence and acknowledged the same to be his act and deed.

In testimony whereof I have hereunto set my hand and affixed my official seal at Johnstown in the county and State aforesaid the 5th day of March, 1883.

[SEAL.] A. MONTGOMERY,  
Notary Public in and for Cambria County,  
State of Pennsylvania.

STATE OF OHIO, }  
Cuyahoga County. }

Before me, L. A. Russell, a Notary Public, in and for said county and State, personally appeared Tom L. Johnston, this 2d day of March, A. D. 1883, and signed the foregoing Articles of Association and acknowledged the same to be his voluntary act and deed for the purposes in said articles expressed.

In testimony whereof I have hereunto set my hand and affixed my notarial seal at Cleveland, Ohio, this second day of March, A. D. 1883.

[SEAL.] L. A. RUSSELL,  
Notary Public in and for Cuyahoga County, Ohio.

79 I, Geo. H. Webb, Clerk of the County Court of Jefferson County, in the State of Kentucky, do certify that on this day the foregoing Articles of Incorporation were produced to me in my office and acknowledged and delivered by J. V. Johnston and Edgar C. Moxham parties thereto to be their act and deed, and that I have recorded them, this and the foregoing certificates in my said office.

Witness my hand this 7th day of March, 1883.

GEO. H. WEBB, Clk.

(The above Articles are recorded in Book No. 2, page 621.)

Amendment to the Articles of Incorporation of the Johnson Steel Street Rail Company.

We, A. J. Moxham, J. V. Johnston, E. C. Moxham and Tom L. Johnson, incorporators and only stockholders of the Johnson Steel Street Rail Company, do hereby agree that the stock of said company shall be increased from twenty-five thousand dollars to forty thousand dollars, that is to say, an increase of one hundred and fifty shares of one hundred dollars each, and one-third of said stock to be paid for in cash and issued at once, and the remainder to be paid for and issued as and when called for by the Board of Directors of said company; and that the stock shall be subscribed for and issued as provided in Section 3 of the charter of said Johnson Steel Street Rail Company.

Witness our hands this fifth day of January, 1884.

TOM L. JOHNSON,  
A. J. MOXHAM,  
EDGAR C. MOXHAM,  
J. V. JOHNSON.

80 STATE OF OHIO, }  
County of Cuyahoga, } ss.

I, L. A. Russell, a Notary Public in and for the county and State aforesaid, do certify that on this day came the above named Tom L. Johnson, who is personally known to me, and signed the foregoing amendment to the Articles of Incorporation of the Johnson Steel Street Rail Company, in my presence, and acknowledged the same to be his free act and deed.

In testimony whereof, I hereunto set my hand and affix my official seal this fifth day of January A. D. 1884.

[SEAL.]

L. A. RUSSELL,  
Notary Public.

STATE OF PENNSYLVANIA, }  
County of Cambria, } ss.

I, A. Montgomery, a Notary Public, in and for the county and State aforesaid, do certify that on this day came the above named A. J. Moxham, who is personally known to me, and signed the foregoing amendment to the Articles of Incorporation of the Johnson Steel Street Rail Company in my presence, and acknowledged the same to be his free act and deed.

In testimony whereof, I hereunto set my hand and affix my official seal this twenty-third day of January, A. D. 1884.

[SEAL.]

A. MONTGOMERY,  
Notary Public.

STATE OF KENTUCKY, }  
 County of Jefferson, } *Set.*

I, R. S. Shreve, at Notary Public in and for the county and State aforesaid, do certify that on this day came the  
 81 above named Edgar C. Moxham, who is personally known to me, and signed the foregoing amendment to the Articles of Incorporation of the Johnson Steel Street Rail Company, in my presence, and acknowledged the same to be his free act and deed.

In testimony whereof, I hereunto set my hand and affix my official seal this twenty-fifth day of January, A. D. 1884.

[SEAL.]

R. S. SHREVE,  
*Notary Public, J. Co., Ky.*

STATE OF KENTUCKY, }  
 Jefferson County, } *Set.*

I, Geo. H. Webb, Clerk of the County Court wherein and for the county and State aforesaid, do certify that on this day the foregoing amendment to the Articles of Incorporation of the Johnson Steel Street Rail Company were produced to me in my office and acknowledged and delivered by Edgar C. Moxham, a party thereto, to be his act and deed, all of which is hereby certified to the proper office for record.

Witness my hand and official seal of Jefferson County Court, this 31st day of January, 1884.

[<sup>Official</sup>  
 Seal.]

GEO. H. WEBB,  
*Clk. Jeff. Co. Ct., Ky.*

I, Geo. H. Webb, Clerk of the County Court of Jackson County, in the State of Kentucky, do certify that on this day the foregoing amendment to the Articles of Incorporation of the Johnson Steel Street Rail Company were further and fully acknowledged and delivered before me, in my office, by J. V. Johnston, a party thereto, to be his act and deed, and  
 82 that I have recorded it, this and the foregoing certificates in my said office.

Witness my hand this 8th day of February, 1884.

GEO. H. WEBB, Clk.

(The above amendment to the Articles of Incorporation of the Johnson Steel Street Rail Company is recorded in Corporation Book No. 3, page 174.)

Change in the Articles of Incorporation of the Johnson Steel Street Rail Company:

Know all men by these presents, that we, A. J. Moxham, Tom L. Johnson, J. V. Johnston, T. C. Coleman, A. V. du Pont and John Townsend, being all of the stockholders of the

Johnson Steel Street Rail Company, have and do hereby agree upon the following changes in the Articles of Incorporation of the said Company:

1st. The capital stock of said company is increased from forty thousand dollars (\$40,000) to two hundred and fifty thousand dollars (\$250,000), being an increase of twenty-one thousand shares of one hundred dollars each, to be issued at once as paid up capital stock. This increase of stock is based upon the accumulated net earnings of the company, the increased value of the patents and properties of the company and the patent and properties of the company acquired since the last increase of its capital stock.

2d. The highest amount of indebtedness or liability to which said corporation is at any time to subject itself is changed from five thousand dollars (\$5,000) to fifty thousand dollars (\$50,000).

83 Witness our hands this fifth day of November, A. D. 1885.

A. J. MOXHAM,  
JOHN TOWNSEND,  
J. V. JOHNSTON,  
TOM L. JOHNSON,  
A. V. DUPONT,  
T. C. COLEMAN.

STATE OF PENNSYLVANIA, }  
County of Cambria, } ss.

I, A. Montgomery, a Notary Public, in and for the county and State aforesaid, do certify that on this day personally appeared before me the within named John Townsend and A. J. Moxham who are personally known to me and signed the within change in the Articles of Incorporation of the Johnson Steel Street Rail Company and acknowledged the same to be their act and deed.

Witness my hand and seal this second day of December, 1885.

[SEAL.]

A. MONTGOMERY,  
Notary Public.

STATE OF IOWA, }  
County of Marshall. }

I, W. L. Dickson, a Notary Public, in and for the county and State aforesaid do certify that on this day personally appeared before me the within named J. V. Johnston, who is personally known to me and signed the within change in the Articles of Incorporation of the Johnson Steel Street Rail Company, and acknowledged the same to be his act and deed.



Witness my hand and seal this seventh day of December,  
1885.

84

[SEAL.]

W. L. DICKSON,  
*Notary Public.*

I, Geo. H. Webb, Clerk of the County Court of Jefferson County, in the State of Kentucky, do certify that on this day the foregoing amended Articles of Incorporation were produced to me in my office, and acknowledged and delivered by A. V. duPont, T. C. Coleman and Tom L. Johnson, parties thereto, to be their act and deed, and that I have recorded them, this, and the foregoing certificates in my said office.

Witness my hand this 4th day of January, 1886.

GEO. H. WEBB, *Clerk.*

(The above change in the Articles of Incorporation of the Johnson Steel Street Rail Company, is recorded in Corporation Book No. 3, page 596.)

Be it known, that a meeting of the stockholders of the Johnson Steel Street Rail Company was held at the company's office in Louisville, Kentucky, on Monday, December 17th, 1888, pursuant to call, and that all of the stockholders of said company and every share of stock issued by said company at said time were present in person or by proxy; that it was unanimously resolved that the name of said company be changed from Johnson Steel Street Rail Company to Johnson Company, and that A. J. Moxham, President, A. V. duPont and T. C. Coleman be appointed to sign and acknowledge the appropriate Amended Articles of Incorporation in behalf of all said stockholders, in order to effect said change, if none. Therefore these

85 presents witness, that the Articles of Incorporation of the Johnson Steel Street Rail Company are hereby amended in this, that the name of said company is hereby changed from Johnson Steel Street Rail Company to, and it shall hereafter be known as Johnson Company.

In testimony whereof, witness the signatures of A. J. Moxham, President, A. V. duPont and T. C. Coleman, in behalf of themselves and all the stockholders of said company, this 17th day of December, 1888.

ARTHUR J. MOXHAM, *Prest.*  
A. V. DUPONT.  
T. C. COLEMAN.

STATE OF PENNSYLVANIA, }  
County of Cambria, } ss.

On this 19th day of December, 1888, personally came before me, a Notary Public in and for said County, A. J. Moxham, President of the Johnson Steel Street Rail Company, who in

due form of law acknowledged the within writing, and signed it in my presence.

Witness my hand and Notarial Seal at Johnstown, Pa., the day and year above stated.

[SEAL.]

A. MONTGOMERY,  
*Notary Public.*

I, Geo. H. Webb, Clerk of the County Court of Jefferson County, in the State of Kentucky, do certify that on this day the foregoing Amended Articles of Incorporation was produced to me in my office and acknowledged and delivered by  
86 T. C. Coleman and A. V. duPont, parties thereto, to be their act and deed.

Witness my hand this 22nd day of December, 1888.

GEO. H. WEBB, *Clerk.*

I, Geo. H. Webb, Clerk of the County Court of Jefferson County, in the State of Kentucky, do certify that on this day the foregoing Amended Articles of Incorporation was again produced to me in my office, and that I have recorded it, this, and the foregoing certificate in my said office.

Witness my hand, this 26 day of Decr., 1888.

GEO. H. WEBB, *Clerk.*

(The above Amended Articles of Incorporation are recorded in Corporation Book No. 5, page 125.)

STATE OF KENTUCKY,  
*County of Jefferson,* } *Sct.*

I, Geo. H. Webb, Clerk of the County Court of Jefferson County, in the State of Kentucky (said Court being a court of record having probate jurisdiction and power to appoint and qualify executors, administrators, guardians, etc., and having a common seal), do certify that the foregoing fifteen pages contain a correct and complete copy of the Articles of Incorporation of the Johnson Steel Street Rail Company and the three amendments thereto, together with the certificates of acknowledgment and record thereof, as taken from the records in my office as Clerk aforesaid.

87 Said original Articles of Incorporation of the Johnson Steel Street Rail Company are recorded in Corporation Book No. 2, page 621; the first amendment thereto in Corporation Book No. 3, page 174; the second amendment thereto in Corporation Book No. 3, page 596; and the third amendment thereto in Corporation Book No. 5, page 125.

In testimony of all which I hereunto set my hand and affix the impression of the seal of Jefferson County, Kentucky, of

which I am the lawful custodian, at Louisville, this 8th day of October, 1889.

[SEAL.]

GEO. H. WEBB, *Clerk*  
*Jefferson County Court, Kentucky.*

STATE OF KENTUCKY, }  
*Jefferson County,* } *Sct.*

I, W. B. Hoke, sole and presiding Judge of the County Court within and for the county and State aforesaid, do certify that Geo. H. Webb, whose genuine signature appears to the foregoing certificate, is now, and was at the time of signing the same, Clerk of said Court, duly elected and qualified, and that all of his official acts as such are entitled to full faith and credit, and that his foregoing attestation is in due form of law.

Given under my hand at the City of Louisville, Kentucky, this 8th day of October, 1889.

(Signed) W. B. HOKE,  
*Sole and Presiding Judge of the Jefferson Co.*  
*Court, Kentucky.*

SS STATE OF KENTUCKY, }  
*Jefferson County,* } *Sct.*

I, Geo. H. Webb, Clerk of the County Court, within and for the county and State aforesaid, do certify that W. B. Hoke, whose genuine signature appears to the foregoing certificate, is now, and was at the time of signing the same, Sole and Presiding Judge of said Court, duly elected, commissioned and qualified, and that all of his official acts as such are entitled to full faith and credit.

In testimony whereof, I hereunto set my hand and affix the official seal of Jefferson County, Kentucky, of which I am the custodian, at Louisville, Kentucky, this 8th day of October, 1889.

[SEAL.]

GEO. H. WEBB, *Clerk.*  
*Jefferson County Court, Kentucky.*

(Endorsed:) Opened and refiled Nov. 20, 1890. L. S. B. Sawyer, Clerk.

89

U. S. Circuit Court, N. Dist. of Cal.

THE JOHNSON CO.

*vs.*

PACIFIC ROLLING MILLS CO. }

No. 10393.

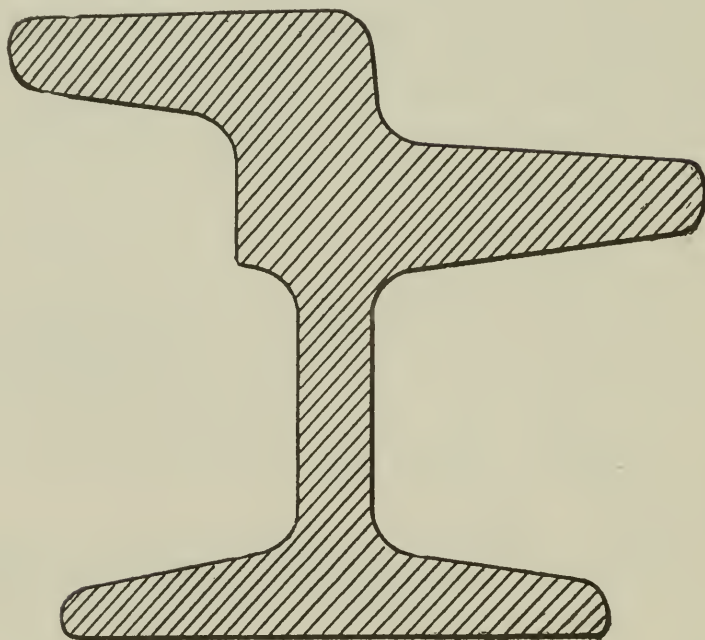
*Complainant's Exhibit E. (Drawing Section of Respondent's Rail.)*S. C. H., *Examiner.*

(Endorsed:) Opened and re-filed Nov. 20, 1890. L. S. B. Sawyer, Clerk.

90

*Assignment of Errors.*

United States Circuit Court of Appeals, for the Ninth Judicial Circuit.

JOHNSON COMPANY,

*vs.*

PACIFIC ROLLING MILLS COMPANY. }

No. 10,393.

In the matter of the appeal of the Johnson Company, appellant:

Assignment of Errors: And now comes the appellant in the above cause, and says that in the record and proceedings therein there is manifest error in this, to wit:

1. The Circuit Court of the United States, for the Northern District of California, erred in the construction placed upon the fifth claim of the patent in suit.

2. The Circuit Court of the United States, for the Northern

District of California, erred in failing to find that defendant's (appellee's), rails infringed the fifth claim of the patent in suit.

3. The Circuit Court of the United States, for the Northern District of California, erred in holding that there was no invention over the prior art in the matter claimed in the fifth claim of the patent in suit.

4. The Circuit Court of the United States, for the Northern District of California, erred in dismissing the bill of complaint in said cause.

Wherefore, the said Johnson Company, appellant, prays that the decree of the Circuit Court of the United States, for the Northern District of California, be reversed, and that the Circuit Court of the United States, for the Northern District of California, be ordered to enter a decree sustaining the bill of complaint, finding that defendant's (appellee's), rails infringe the fifth claim of the patent in suit, and awarding an injunction against the defendant (appellee), in accordance with the prayer of the bill of complaint.

WM. F. BOOTH,

*Attorney for Johnson Company.*

(Endorsed:) Filed Dec. 28, 1891. L. S. B. Sawyer, Clerk.

92 *Petition for Order Allowing Appeal.*

In the Circuit Court of the United States. Ninth Judicial Circuit, in and for the Northern District of California.

THE JOHNSON COMPANY, Complainant,	) No. 10,393. ) In Equity.
<i>vs.</i>	
PACIFIC ROLLING MILLS COMPANY, Defendant.	

*Petition of Complainant for Order Allowing Appeal.*

The Johnson Company, complainant in the above entitled cause, feeling itself aggrieved by the decretal order made by said Court on the 27th day of July, 1891, and the decree made and entered on said day in pursuance of said order, whereby it is ordered, adjudged and decreed that the complainant's bill of complaint in said cause be dismissed with costs to the defendant, comes now by George Harding, George J. Harding and Wm. F. Booth, its solicitors and counsel, and petitions said Court for an order allowing said complainant to prosecute an appeal from said decree, to the Honorable, the United States Circuit Court of Appeals, for the Ninth Circuit, under and according to the laws of the United States in that behalf made and provided, and also that an order be made fixing the amount of security which complainant shall give and furnish upon such

appeal, and that upon giving of such security, all further proceedings in this Court be suspended and stayed until the determination of said appeal by said United States Circuit Court of Appeals.

93 And your petitioner will ever pray.

GEORGE HARDING,  
GEORGE J. HARDING,  
WM. F. BOOTH.

Sol's and counsel for complainant.

(Endorsed:) Filed Dec. 28, 1891. L. S. B. Sawyer, Clerk.

94 *Order Allowing Appeal.*

At a stated term, to wit: the November term, A. D. 1891, of the Circuit Court of the United States of America, of the Ninth Judicial Circuit, in and for the Northern District of California, held at the court room in the City and County of San Francisco, on Monday, the 28th day of December, in the year of our Lord one thousand eight hundred and ninety-one.

Present: The Honorable Thomas P. Hawley, United States District Judge, District of Nevada.

THE JOHNSON COMPANY,

*vs.*

PACIFIC ROLLING MILLS COMPANY,

} No. 10,393.

On motion of W. F. Booth, Esq., counsel for complainant herein, it is ordered that an appeal to the United States Circuit Court of Appeals for the Ninth Circuit, from the final decree heretofore filed and entered herein, be and the same hereby is allowed, and that a certified transcript of the record, testimony, exhibits, stipulations and all proceedings herein be forthwith transmitted to the said United States Circuit Court of Appeals.

It is further ordered that the bond for damages and costs on appeal be, and the same hereby is fixed at five hundred dollars.

95 *Bond on Appeal.*

United States Circuit Court of Appeals for the Ninth Circuit.

THE JOHNSON COMPANY, Appellant,

*vs.*

PACIFIC ROLLING MILLS COMPANY, Appellee,

} No. 10,393.  
} In Equity.

Know all men by these presents, that we, Wm. F. Booth and J. B. Whitcomb, both of San Francisco, California, are held and firmly bound unto the above named appellee, in the sum of five hundred dollars, lawful money of the United States of America, to be paid to the said appellee, its successors and legal

representatives, to which payment, well and truly to be made, we bind ourselves and each of us jointly and severally and our and each of our heirs, executors and administrators firmly by these presents. Dated at San Francisco, California, this 29th day of December, 1891.

The condition of the above obligation is such, that whereas said appellant has taken an appeal to the United States Circuit Court of Appeals, for the Ninth Circuit, to reverse the decree rendered and entered by the Circuit Court of the United States, Ninth Judicial Circuit, in and for the Northern District of California, in the cause entitled *The Johnson Company vs. Pacific Rolling Mills Co.*, No. 10,393, which said decree was rendered and entered in said Circuit Court, the 27th day of July, 1891, being a day in the July term, 1891, of said Circuit Court. Now, therefore, if the above named appellant shall prosecute its appeal to effect and answer all damages and costs, if it shall fail to make good its plea, then this obligation shall be void—otherwise to remain in full force and effect.

WM. F. BOOTH,  
J. B. WHITCOMB.

Signed sealed and delivered in presence of F. D. Monckton.

UNITED STATES OF AMERICA,  
*Northern District of California,* } ss.

Wm. F. Booth, being duly sworn, deposes and says that he is a freeholder in said district, and is worth the sum of five hundred dollars in lawful money of the United States of America, exclusive of property exempt from execution and over and above all debts and liabilities.

WM. F. BOOTH.

Subscribed and sworn to before me, at San Francisco, California, this 29th day of December, 1891.

F. D. MONCKTON,  
*Commissioner U. S. Circuit Court,*  
*Northern District of California.*

UNITED STATES OF AMERICA,  
*Northern District of California,* } ss.

J. B. Whitcomb, being duly sworn, deposes and says that he is a freeholder in said district, and is worth the sum of five hundred dollars in lawful money of the United States of America, exclusive of property exempt from execution and over and above all debts and liabilities.

J. B. WHITCOMB.

Subscribed and sworn to before me, at San Francisco, California, this 29th day of December, 1891.

F. D. MONCKTON.

*Commissioner U. S. Circuit Court,  
Northern District of California.*

(Endorsed:) Form of bond and sufficiency of sureties approved. Hawley, Judge. Filed Dec. 29, 1891. L. S. B. Sawyer, Clerk.

98      *Order Allowing Withdrawal of Original Exhibits.*

At a stated term, to wit: the November term, A. D. 1891, of the Circuit Court of the United States of America, of the Ninth Judicial Circuit, in and for the Northern District of California, held at the court room in the City and County of San Francisco, on Monday, the 25th day of January, in the year of our Lord one thousand eight hundred and ninety-two.

Present: The Honorable Thomas P. Hawley, United States District Judge, District of Nevada.

THE JOHNSON COMPANY,	} No. 10,393.
<i>vs.</i>	
PACIFIC ROLLING MILLS COMPANY.	

Upon motion of Wm. F. Booth, Esq., counsel for the complainant, it is ordered that the original exhibits "Complainant's Exhibit Section of Defendant's Rail," and "Section California Street Rail," (being sections of steel rails) heretofore filed herein, be allowed to be withdrawn from the files of this cause, for the purpose of being transmitted to the United States Circuit Court of Appeals, for the Ninth Circuit, as a part of the record upon appeal herein; the said original exhibits to be delivered to the solicitor for the complainant herein, and to be returned to the files of this cause in this court, upon the final determination of the appeal herein by said United States Circuit Court of Appeals.

In the Circuit Court of the United States, Ninth Judicial Circuit, Northern District of California.

THE JOHNSON COMPANY,	} No. 10,393.
<i>vs.</i>	
PACIFIC ROLLING MILLS COMPANY.	

I, L. S. B. Sawyer, Clerk of the Circuit Court of the United States of America, of the Ninth Judicial Circuit, in and for the Northern District of California, do hereby certify the fore-



going ninety-eight written and printed pages, numbered from 1 to 98, inclusive (excepting therefrom the original exhibits "Complainant's Exhibit Section of Defendant's Rail," and "Section California Street Rail," being sections of steel rails—which said original exhibits are, by order of Court, transmitted herewith and made a part hereof), to be a full, true and correct copy of the record and of all the proceedings in the above and therein entitled suit, and that the same together constitute the transcript of the record upon appeal to the United States Circuit Court of Appeals for the Ninth Circuit.

In testimony whereof, I have hereunto set my hand and affixed the seal of said Court, this 30th day of January, 1892.

[Seal U. S. Circuit Court, Northern Dist. Cal.]

L. S. B. SAWYER,

*Clerk U. S. Circuit Court, Northern District of California.*

UNITED STATES OF AMERICA, ss.

The President of the United States, to Pacific Rolling Mills Company, greeting:

You are hereby cited and admonished to be and appear at a United States Circuit Court of Appeals, for the Ninth Circuit, to be holden at the City of San Francisco, in the State of California, on the 23rd day of February, next, pursuant to an order allowing an appeal, entered in the Clerk's Office of the Circuit Court of the United States, for the Northern District of California, from a final decree duly signed, filed and entered in that certain suit wherein The Johnson Company is complainant and appellant, being in Equity No. 10,393, and you are respondent and appellee, to show cause, if any there be, why the decree rendered against the said appellant as in the said order allowing appeal mentioned, should not be corrected, and why speedy justice should not be done to the parties in that behalf.

Witness, the Honorable Thomas P. Hawley, U. S. District Judge, District of Nevada, assigned to hold and holding the United States Circuit Court, for the Northern District of California, this 25th day of January, A. D. 1892.

THOMAS P. HAWLEY,

*U. S. Judge.*

Service of the within citation and the delivery of a copy thereof acknowledged this 25th day of January, 1892.

WHEATON, KALLOCH & KIERCE,

*Sols. for Respondent and Appellee.*

Filed Jan. 25, 1892. L. S. B. Sawyer, Clerk U. S. Circuit Court Northern District of California. By W. B. Beazley, Deputy Clerk.



# TRANSCRIPT OF RECORD.

---

---

UNITED STATES CIRCUIT COURT OF APPEALS  
FOR THE NINTH CIRCUIT.

OCTOBER TERM, 1891.

No. 34.

---

THE JOHNSON COMPANY,

APPELLANT,

*vs.*

SUTTER STREET RAILWAY COMPANY,

APPELLEE.

---

TRANSCRIPT ON APPEAL.

(FROM U. S. CIRCUIT COURT, NORTHERN DISTRICT OF CALIFORNIA.)

---

---

FILED, FEBRUARY 18, 1892.

FILED  
FEB 24 1892



UNITED STATES CIRCUIT COURT OF APPEALS  
FOR THE NINTH CIRCUIT.

---

THE JOHNSON COMPANY,

APPELLANT,

*vs.*

SUTTER STREET RAILWAY COMPANY,

APPELLEE.

---

TRANSCRIPT ON APPEAL.

(FROM U. S. CIRCUIT COURT, NORTHERN DISTRICT OF CALIFORNIA.)

---

INDEX.

	Original.	Print.
Answer .....	9	5
Assignment of Errors .....	88	60
Bill of Complaint .....	1	1
Bond on Appeal .....	93	62
Certificate to Enrollment .....	20	12
Certificate to Deposition .....	42	25
Certificate to Deposition .....	68	41
Complainant's Exhibit "Brevoort Diagram" .....	45	27
Caption to Deposition .....	46	38
Complainant's Exhibit A .....	69	43
Complainant's Exhibit B .....	70	49
Complainant's Exhibit C .....	73	51
Complainant's Exhibit E .....	87	60
Decree .....	17	10
Deposition of Henry L. Brevoort .....	32	19
Deposition (introduction of evidence) .....	47	28
Deposition of Patrick Noble .....	50	30
Enrollment .....	16	9
Exhibit "Drawing of Complainant's Exhibit E" .....	44	26
Memorandum of costs and disbursements .....	18	10
Opinion .....	21	12
Order Allowing Appeal .....	92	62
Order Allowing Withdrawal of Original Exhibits .....	96	64
Petition for Order Allowing Appeal .....	90	61
Replication to Answer .....	15	9
Subpœna <i>ad respondendum</i> .....	7	4



1

*Bill of Complaint.*

Circuit Court of the United States, in and for the Northern  
District of California. In Equity.

No. 10394. February Session, 1889.

THE JOHNSON COMPANY	} Johnson Patent,
<i>vs.</i>	
SUTTER STREET RAILWAY COMPANY.	} No. 272,554.

To the Honorable the Judges of the Circuit Court of the United  
States, in and for the Northern District of California.

The Johnson Company, a corporation organized by virtue of  
and under the laws of the State of Kentucky, and a citizen of  
that State, brings this its bill against the Sutter Street Railway  
Company, a corporation organized by virtue of and under the  
laws of the State of California, and a citizen of that State, and  
having its principal office in the city of San Francisco, in the  
county of San Francisco, in said State.

And thereupon your orator complains, and says that hereto-  
fore, on or about the 17th day of December, 1888, under and by  
virtue of the laws of the State of Kentucky, the name of the  
said Johnson Company was changed from the "Johnson Steel  
Street Rail Company" to "Johnson Company."

And your orator further shows unto your Honors, that here-  
tofore, and before the twentieth day of February, A. D., 1883,  
Tom L. Johnson, of the city of Indianapolis, State of Indiana,  
was the true, original and first inventor of a certain new and  
useful improvement in street-railroad rail, not known or used  
before, and not in public use or on sale for more than two years  
prior to his application for a patent therefor.

2 And your orator further shows unto your Honors, that  
the said Tom L. Johnson, so being the inventor of the said  
improvement in street-railroad rail, made application to the  
proper department of the Government of the United States for  
letters patent in accordance with the then existing Acts of Con-  
gress, and duly complied in all respects with the conditions and  
requirements of the said Acts of Congress, and that on the twen-  
tieth day of February, A. D. 1883, Letters Patent Numbered  
272,554, in due form of law, were issued and delivered to the said  
Tom L. Johnson, for the said invention or discovery, in the name  
of the United States of America, and under the seal of the Patent  
Office of the United States, and were signed by the Secretary of  
the Interior Department of the United States, and counter-  
signed by the Commissioner of Patents, whereby there was  
granted to the said Tom L. Johnson, his heirs, executors, ad-  
ministrators or assigns, for the term of seventeen years from  
the twentieth day of February, A. D. 1883, the full and exclu-  
sive right of making, using and vending the said invention or

discovery throughout the United States and Territories thereof, as by said letters patent, or a duly authenticated copy thereof, ready in court to be produced, will more fully and at large appear.

And your orator further shows unto your Honors, that the said Tom L. Johnson, on the ninth day of March, A. D. 1883, by an instrument in writing, duly executed and delivered, and bearing date of the last named day, did assign unto your orator, the Johnson Company (formerly the Johnson Steel Street Rail Company) the whole right, title and interest in and to the said letters patent and the invention therein described, the said assignment having been duly recorded in the Patent  
 3 Office of the United States on the thirtieth day of April, 1883, in Liber R. 29, page 184, as by the said assignment, or a duly authenticated copy thereof, ready in court to be produced, will more fully and at large appear.

And your orator further shows unto your Honors that, but for the infringement herein complained of, and others of like character, it would have been, and would still be, in the undisturbed possession, use and enjoyment, of the exclusive privileges secured by the said letters patent.

And your orator further shows unto your Honors that, as it is informed and believes, the said Sutter Street Railway Company, well knowing all the facts set forth, did make and use the said patented improvement, or street-railroad rails, substantially the same in construction and operation as in the said letters patent are shown, described and claimed, the exclusive right to make, use and vend, which said patented street-railroad rails throughout the United States and Territories thereof, is by law vested in your orator.

And so it is, may it please your Honors, that the said respondent, as your orator is informed and believes, without the license of your orator, against its will and in violation of its rights, has made and used, and intends to continue still to make and use, the said patented improvement within the Northern District of California and elsewhere, all of which is in violation of the said letters patent, and to the great gain and profit of the respondent and to the great loss of your orator.

And now, to the end that the respondent may be compelled to account for and pay over the income thus unlawfully derived  
 4 from the violation of the rights of your orator as above, and be restrained from any further violation of the said rights, your orator prays that your Honors may grant a permanent writ of injunction issuing out of and under the seal of this Honorable Court, directed to the said Sutter Street Railway Company.

Strictly enjoining and restraining it, its officers, agents and



employees from any further construction, use or sale in any manner, of said patented improvement in street-railroad rails, or any part or parts thereof, in the violation of the rights of your orator, and that all specimens of the said improvement, or any part or parts thereof, in the possession or use or under the control of the said respondent, the Sutter Street Railway Company, may be destroyed or delivered up to your orator for that purpose.

Your orator also prays that your Honors, upon the entering of a decree for an infringement, as above prayed for, may proceed to assess, or cause to be assessed, under your direction, in addition to the profits to be accounted for by the respondent aforesaid, the damages your orator has sustained by reason of such infringement, and that your Honors may increase the actual damages so assessed to a sum equal to three times the amount of such assessment, under the circumstances of the wilful and unjust infringement by the said respondent, as herein set forth.

And your orator prays also for a provisional or preliminary injunction against the said respondent, and for such other relief, together with the costs of the suit, as the equity of the case may require and to your Honors may seem meet.

To the end, therefore, that the respondent may, if it can show reason why your orator should not have the relief herein prayed for, and that the said respondent may make a  
5 full disclosure and discovery of all the matters aforesaid, under the oath of its proper officers, and according to the best and utmost of their knowledge, remembrance, information and belief, full, true, direct and perfect answer make to the several allegations of this bill, as though specially interrogated relative thereto.

May it please your Honors to grant unto your orator, not only a writ of injunction conformable to the prayer of this bill, but also a writ of subpœna of the United States of America, issuing out of and under the seal of this Honorable Court, directed to the respondent herein, the said Sutter Street Railway Company, commanding it to appeal and answer unto this bill of complaint, and to abide by and perform such order and decree in the premises as to the Court shall seem meet, and be required by the principles of equity and good conscience.

And your orator will ever pray.

GEORGE HARDING,  
*Solicitor for Complainant.*

GEORGE HARDING,  
WM. F. BOOTH,  
GEORGE J. HARDING,  
BUTLER KENNER HARDING,  
*Of Counsel for Complainant.*

6 STATE OF PENNSYLVANIA, }  
 County of Cambria, } ss.

Arthur J. Moxham, being duly sworn according to law, doth depose and say: That he is the President of the corporation, the Johnson Company, the complainant named in the foregoing bill of complaint; that he has read the foregoing bill of complaint and knows the contents thereof, and that so far as the statements therein contained are within his own knowledge, they are true, and so far as they are derived from the information of others, he verily believes them to be true.

And he further doth depose and say: That he verily believes the said Tom L. Johnson, in the said bill of complaint named, to be the true, original and first inventor of the street-railroad rails which are described in the said letters patent granted to him, and mentioned in the foregoing bill of complaint.

And he doth further depose and say: That he verily believes the title of complainant as set forth in the said bill is true.

ARTHUR J. MOXHAM.

Subscribed and sworn to before me this 13th day of May, A. D. 1889.

[SEAL.]

A. MONTGOMERY.

*A Notary Public of the State of Pennsylvania,  
 in and for the County of Cambria.*

(Endorsed:) Filed June 4th, 1889. L. S. B. Sawyer, Clerk.

7

*Subpoena.*

UNITED STATES OF AMERICA:

Circuit Court of the United States, Ninth Judicial Circuit,  
 Northern District of California. In Equity.

The President of the United States of America, Greeting: To the Sutter Street Railway Company, a corporation, organized by virtue of and under the laws of the State of California.

You are hereby commanded, That you be and appear in said Circuit Court of the United States aforesaid, at the court room in San Francisco, on the first day of July, A. D. 1889, to answer a Bill of Complaint exhibited against you in said Court by the Johnson Company, a corporation, organized by virtue of and under the laws of the State of Kentucky, and a citizen of that State, and to do and receive what the said Court shall have considered in that behalf. And this you are not to omit, under the penalty of five thousand dollars.

Witness, the Honorable Melville W. Fuller, Chief Justice of the Supreme Court of the United States, this 4th day of June, in the year of our Lord one thousand eight hundred and eighty-nine, and of our independence the 113th.

[SEAL.]

L. S. B. SAWYER, *Clerk.*

*Memorandum Pursuant to Rule 12, Supreme Court U. S.*

You are hereby required to enter your appearance in the above suit, on or before the first Monday of July next, at the Clerk's Office of said Court, pursuant to said bill; otherwise the said bill will be taken *pro confesso*.

L. S. B. SAWYER, *Clerk.*

(Endorsed:)

UNITED STATES MARSHAL'S OFFICE,  
NORTHERN DISTRICT OF CALIFORNIA.

I hereby certify that I received the within writ on the 4th day of June, 1889, and personally served the same on the 5th day of June, 1889, upon the Sutter Street Railway Company, by delivering to and leaving with R. L. Morrow, President of the Sutter Street Railway Company, said defendant named therein, personally, at the City and County of San Francisco, in said District, an attested copy thereof.

J. C. FRANKS,

*U. S. Marshal,*

By JAMES R. DEANE,

*Deputy.*

San Francisco, June 5th, 1889.

Filed June 5, 1889.

L. S. B. SAWYER, *Clerk.*

9

*Answer.*

In the Circuit Court of the United States, Ninth Circuit, in and for the Northern District of California.

THE JOHNSON COMPANY, Complainant,

*vs.*

SUTTER STREET RAILWAY COMPANY, Defendant. }

The answer of the Sutter Street Railway Company, the defendant to the bill of complaint of the complainant, herein filed.

This defendant now, and at all times hereafter, saving and reserving unto itself all benefit and advantage of exception which can or may be had or taken to the many errors, uncertainties and other imperfections in the said complainant's said

bill of complaint contained, for answer thereto, or unto so much and such parts thereof as this defendant is advised, is or are material or necessary for it to make answer unto, this defendant, for answering, saith:

Defendant says that it is not advised, save by said bill, whether the name of the Johnson Steel Street Rail Company was changed to "Johnson Company," as alleged in said bill, or not; it therefore denies that the said name was so changed, and leaves the complainant to make such proof thereof as it may be able to do.

That the defendant admits that Letters Patent Numbered 272,554, and bearing date on the 20th day of February, 1883, for an alleged improvement in street railroad rails, were granted by the Government of the United States to Tom L. Johnson, as alleged in the said bill. But the defendant denies that the alleged invention which was covered by said letters patent was either new or useful; on the contrary, the defendant avers that it is informed and believes, and so states to be true, that the said alleged improvement which was covered by said letters patent has never been used by the owners of said letters patent or by anyone else, for the reason that it was not useful. That the said alleged invention was for rolling said rails in a peculiar form, and that said form was injurious and not beneficial to said rails, and the same was not and never has been of any utility, or of any value whatever.

Defendant denies that the said letters patent are valid, or that they cover or protect any patentable invention, or that they have secured to the said Tom L. Johnson, or his assigns, any exclusive right of making, or using, or vending the said alleged invention or discovery throughout the United States, or any part thereof, or in any place, or for any time.

Defendant avers that it is not informed, save by said bill, as to whether said letters patent were assigned to the Johnson Steel Street Rail Company, as alleged in said bill, or not. It therefore denies that the same were so assigned, and leaves the complainant to make such proof thereof as it may be advised and be able to do.

This defendant denies that, except for the infringement complained of, or any infringements, the complainant would be in the undisturbed use and enjoyment of the exclusive privileges secured by the said letters patent. On the contrary, the defendant avers that it is informed and believes, and so states to be true, that the said letters patent never have been infringed and the possession by the complainant of the alleged invention has never been disturbed; but notwithstanding these facts, the complainant has neither used or enjoyed the said exclusive privileges, or any of them.

This defendant, the Sutter Street Railway Company denies that it has either made or used the said patented improvement or street railroad rails, or any railroad rails which were substantially, or at all, the same in construction, or operation, as those shown, described and claimed in the said letters patent. This defendant denies that it has ever made, or has ever used, or that it intends, or ever intended, or that it will under any circumstances either make, or use in the future, the said patented improvement, either within the Northern District of California, or in any place whatever, either to the great gain and profit of this defendant, or to the great loss of the complainant or at all.

And this defendant denies that it has infringed upon said letters patent, or that it is now infringing upon said letters patent, or that it will in the future infringe upon said letters patent, and denies that it intends or ever intended to infringe upon said letters patent; and denies that it has obtained, or in any way realized any income, or gains, or profits from any infringement of said letters patent, and denies that the complainant has sustained any loss or any damage or that it will sustain any loss or any damage on account of any infringement of said letters patent by this defendant.

And further answering this defendant avers that it is informed and believes and so states to be true, that the said letters patent are null and void for the reason that the effects stated therein will not be produced by the means therein described for producing those effects. Defendant avers that the pocket formed between the head and foot of the rail described

12       therein will not clasp and hold street ballast and thereby prevent the wearing away of the street alongside of said rail as stated in the said bill of complaint. Neither are the masses of metal in the head, web, flange and foot of the rail described in the patent so nearly equal that all parts will shrink alike and obviate the necessity of cambering in rolling said rails as stated in said patent, and defendant states generally that the changes which are claimed in said patent to be produced by the peculiar forms therein described will not be so produced by those forms.

Defendant avers and will prove on the trial of this case that street railroad rails similar to those described in said letters patent and with pockets formed on each side of the webs thereof, for the reception of the street ballast long prior to the alleged invention of the patentee, Tom L. Johnson, were in public use on California street, between Kearny and Larkin streets, in the City and County of San Francisco in the State of California. That the same were so used by the California Street Railway Company, which had, and still has, its principal place of

business and residence at the southeast corner of said California and Larkin streets in said City and County of San Francisco.

This defendant further avers and will prove on the trial of this cause that street railroad rails, similar to those described in said letters patent, and with pockets formed on each side of the webs thereof for the reception of street ballast as therein described, were shown and described in the following described letters patents, each one of which was granted by the government of the United States to Henry Root of the City and County of San Francisco, viz:

13 Letters Patent Numbered 262,126, applied for on the third day of September, 1881, and bearing date on the first day of August, 1882, and being granted for a "Construction of Cable Railways."

Also Letters Patent Numbered 247,781, applied for on the sixth day of May, 1881, and bearing date on the fourth day of October, 1881, and being granted for a "Cable Railroad."

And further answering, the said defendant denies that the said complainant is entitled to the relief or any part thereof in the said bill of complaint demanded. And this defendant prays the same advantage of its aforesaid answer, as if it had pleaded or demurred to the said bill of complaint, and this defendant prays leave to be dismissed with its reasonable costs and charges in this behalf most wrongfully sustained.

M. A. WHEATON,  
*Solicitor for Defendant.*

NAPHTALY, FREIDENRICH & ACKERMAN,  
*Of Counsel for Defendant.*

STATE OF CALIFORNIA, }  
*City and County of San Francisco,* } ss.

Joseph L. Schmitt, being duly sworn, does depose and say, that he is an officer, to wit: Vice-President of the Sutter Street Railway Company, the defendant in the foregoing answer, and that by means of his said office he has acquired and possesses particular knowledge of the matters stated in said answer; that he has read the foregoing answer and knows the contents thereof, and that the same is true of his own knowledge except as to the matters therein stated on information and belief,  
14 and as to those matters he verily believes it to be true.

JOS. L. SCHMITT.

Subscribed and sworn to before me, this 5th day of August, A. D. 1889.

[SEAL.]

JAMES MASON,  
*Notary Public.*

(Endorsed:) Service of the within answer and receipt of a copy thereof admitted this 5th day of August, 1889. Wm. F. Booth, Solicitor for Plaintiff. Filed 5th day of August, A. D. 1889. L. S. B. Sawyer, Clerk.

15 *Replication to Answer.*

In the Circuit Court of the United States, Ninth Judicial Circuit, in and for the Northern District of California.

THE JOHNSON COMPANY, Complainant,	} In Equity.
<i>vs.</i>	
SUTTER STREET RAILWAY COMPANY, Respondent.	} No. 10394.
	} Replication.

This repliant, saving and reserving unto itself all and all manner of advantage of exception to the manifold insufficiencies of the said answer, for replication thereunto saith, that it will aver and prove its said bill to be true, certain, and sufficient in the law to be answered unto; and that the said answer of the said defendant is uncertain, untrue, and insufficient to be replied unto by this repliant; without this, that any other matter or thing whatsoever in the said answer contained, material or effectual in the law to be replied unto, confessed or avoided, traversed or denied, is true; all which matters and things this repliant is, and will be, ready to aver and prove, as this Honorable Court shall direct; and humbly prays, as in and by its said bill it hath already prayed.

WM. F. BOOTH,  
*Of Counsel for Complainant.*

Service of the above replication admitted this 2nd day of September, 1889.

M. A. WHEATON,  
*Defendant's Solicitor.*

(Endorsed:) Filed Sept. 2nd, 1889. L. S. B. Sawyer, Clerk. By F. D. Monckton, Deputy Clerk.

16 *Enrollment.*

In the Circuit Court of the United States, Ninth Circuit, Northern District of California.

THE JOHNSON Co., Complainant,	} No. 10394.
<i>vs.</i>	
SUTTER STREET RAILWAY Co., Respondent.	

The complainant filed its bill of complaint on the 4th day of June, 1889, which is hereto annexed.

A subpoena to appear and answer in said cause was thereupon issued, returnable on the 1st day of July, A. D. 1889, which is hereto annexed.

The respondent appeared herein on the 1st day of July, 1889, by Naphtaly, Freiderich & Ackerman, Esqrs., its solicitors.

On the 5th day of August, 1889, an answer was filed herein, which is hereto annexed.

On the 2nd day of September, 1889, a replication was filed herein and is hereto annexed.

Thereafter a final decree was filed and entered herein in the words and figures following, to wit:

17

*Decree.*

At a stated term, to wit: the July term, A. D. 1891, of the Circuit Court of the United States of America, of the Ninth Judicial Circuit, in and for the Northern District of California, held at the court room in the City and County of San Francisco, on Monday the 27th day of July, in the year of our Lord one thousand eight hundred and ninety-one.

Present: The Honorable Thomas P. Hawley, U. S. District Judge, District of Nevada.

THE JOHNSON COMPANY,  
*vs.*  
 SUTTER STREET RAILWAY COMPANY. } No. 10394.

This cause came on to be heard at the July, 1890, term of said Court, and was argued by counsel, and submitted to the Court for consideration and decision.

Thereupon, upon consideration thereof, it is ordered, adjudged and decreed that the complainant's bill of complaint herein, be and the same hereby is dismissed at complainant's cost, taxed at \$89.75.

(Signed) HAWLEY,  
*Judge.*

(Endorsed:) Filed and entered July 27, 1891. L. S. B. Sawyer, Clerk.

18

*Memorandum of Costs and Disbursements.*

United States of America. Circuit Court of the United States,  
 Ninth Circuit, Northern District of California.

THE JOHNSON COMPANY, Complainant, } Memorandum  
*vs.* } of Costs and  
 SUTTER STREET RAILWAY COMPANY, Defendant. } Disbursements

Disbursements:

Copy of the bill of complaint.....\$ 2 00  
 Clerk's fees..... 10 00



Deposition fees for 2 witnesses, Henry L. Brevoort and Patrick Noble, at \$2.50 each.....	\$5 00
Examiner's fees.....	52 00
Docket fee.....	20 00
Affidavit to answer.....	50
Affidavit to cost bill.....	25

Taxed at.....Total sum..\$89.75

L. S. B. SAWYER,  
*Clerk.*

UNITED STATES OF AMERICA,  
*Northern District of California,* }  
*City and County of San Francisco,* } ss.

F. J. Kierce being duly sworn, deposes and says: That he is one of the solicitors for the defendant in the above entitled cause, and as such is better informed, relative to the above costs and disbursements, than the said defendant.

That the items in the above memorandum contained are correct, to the best of this deponent's knowledge and belief,  
19 and that the said disbursements have been necessarily incurred in the said cause.

(Signed) F. J. KIERCE.

Subscribed and sworn to before me, this 30th day of July,  
A. D. 1891.

F. D. MONCKTON,  
*Commissioner of U. S. Circuit Court,*  
*Northern District of California.*

To Messrs. George Harding, G. J. Harding and Wm. F. Booth,  
Solicitors for Complainant:

You will please take notice that on Saturday, the first day of August, A. D. 1891, at the hour of 10:30 o'clock, A. M., we will apply to the Clerk of said Court to have the within memorandum of costs and disbursements taxed pursuant to the rule of said Court, in such case made and provided.

WHEATON, KALLOCH & KIERCE,  
*Solicitors for Defendant.*

(Endorsed:) Service of within memorandum of costs and disbursements, and receipt of a copy thereof acknowledged, this 30th day of July, A. D. 1891. Wm. F. Booth, Solicitor for Complainant. Filed this 31st day of July, A. D. 1891. L. S. B. Sawyer, Clerk.

*Certificate to Enrollment.*

Whereupon, said pleadings, subpoena and final decree and a memorandum of taxed costs are hereto annexed, said final decree being duly signed, filed and enrolled, pursuant to the practice of said Circuit Court.

Attest, etc.

[SEAL.]

L. S. B. SAWYER, *Clerk.*

(Endorsed:) Enrolled papers. Filed July 27, 1891. L. S. B. Sawyer, Clerk.

*Opinion.*

In the Circuit Court of the United States, Ninth Judicial Circuit, Northern District of California.

JOHNSON COMPANY, Complainant,

*vs.*

PACIFIC ROLLING MILLS COMPANY, Respondent, } No. 10393.

AND

JOHNSON COMPANY, Complainant,

*vs.*

SUTTER STREET RAILWAY COMPANY, Respondent. } No. 10394.

July 27, 1891.

WM. F. BOOTH and HARDING & HARDING, for complainants,  
both cases: WHEATON, KALLOCH & KIERCE, and NAPHTALY,  
FREIDENRICH & ACKERMAN, for respondents.

HAWLEY, J.

These cases were tried together, and involved precisely the same questions.

They are actions in equity to recover for an alleged infringement of Letters Patent Number 272,554, bearing date February 20, 1883, granted to Tom L. Johnson, for a street railroad, and by him assigned to the corporation complainant in both cases. The alleged infringement is for the manufacture and sale of certain rails by the Pacific Rolling Mills Company in one case, and in the other case, for the use of said rails by the Sutter Street Railway Company.

The specifications of the patent are quite lengthy. The following quotations therefrom have more or less bearing upon the points involved:

“The object of my said invention is to improve the form of that class of railroad rail, used principally by street railroads, which combine the principal features of the tramrail, ordinarily used for such purposes, and those of the T-rail used on steam railroads.

“ I am aware that rails embodying the general features above mentioned are old, and I therefore disclaim the same, and confine myself to the form hereinafter particularly described and claimed as new.

“ Referring to the accompanying drawings, which are made a part hereof, and on which similar letters of reference indicate similar parts, Figure 1 is a perspective view of a portion of a rail formed in accordance with my invention, and Fig. 2, a transverse vertical section of the same. Fig. 3 shows a section of a street railway bed and ordinary rails as commonly laid.

“ In said Figs. 1 and 2 the letter A indicates the flanged portion of the rail; B, the head of the rail; C, an offset under the head of the rail, abutting the web E on the side of said web, opposite to that continued out in the flange A. The web E extends from the foot D to the angles respectively formed on opposite sides by its union with the offset C and flange A, thus securing a uniform depth of web proper for the fish-plates to clamp.

“ In Fig. 3 the letter G indicates an ordinary cross-tie, the letters HH, stringers, such as are ordinarily used upon street railways, and KK an ordinary form of street rail laid thereon. The letters *xx* indicate the edges of the adjacent and underlying roadway.

“ A peculiar and important feature of this rail is the offset C, which, while serving the purpose of a close fit for the splice-bar or fish-plate, as above mentioned, also serves another equally or more important purpose in the general conformation of and peculiar disposition of metal in the rail.”

“ The splice-bar offset C, is a large factor, in the proper retaining of this ballast, for it is large enough with its square corner, in connection with the curved or arched shape of the lower part of the head and T shaped foot to allow the surrounding and superincumbent traffic to press the ballast—gravel and stones of the streets—into and against the rail, instead of (as shown in Fig. 3—cutting away the surface of the street from the rails.”

There are six claims to the patent; but only one—the fifth—that it is contended is infringed. This claim reads as follows: “ 5. In the combined tram and T rail described, the web E, located relatively to the flange A, and head B, offset at C, as described, whereby a maximum capacity of outside pocket is secured with a minimum quantity of metal consistent with the proper stability of the rail, substantially as set forth.”

The defenses to this patent, set up by defendants, are (1) non-infringement (2) non-patentability.

1. In construing the patent it is the duty of the Court to confine its deliberations to the fifth claim as that is the only one

that is claimed to be infringed. It is also proper to restrict the interpretation of the patent to the particular class to which it belongs, viz: to patents for mere form, as distinguished from patents involving mechanical action or patents for some particular kind of process. This case is one “where in view  
24 of the state of the art, the invention must be restricted to the form shown and described by the patentee.”

*Duff vs. Sterling Pump Co.*, 114 U. S., 639.

The fifth claim required the web E, to be located relatively to the flange A, and head B, as described. This relative location, when compared with the drawings and specifications places the head B, to the left hand side of the vertical line of the web E, and the whole of the upper face of the flange A, over the whole width of the web. The form of the defendant's rail, in this respect, locates the head over the web, and the flange is to the right of the vertical line of the web. The difference in the relative location of the different parts of the patented rail and of the defendant's rail is shown in the cross-examination of complainant's expert witness, Breevort, who, in answer to questions, testified as follows:

“Q. 8. In the patented rail is there any part of the head that is over the web in a vertical line?

“A. No.

“Q. 9. In the defendant's rail is the head in vertical line over the web or not?

“A. The head is over the web.

“Q. 10. Then in this respect referred to in the last two questions is the relative location of the head and web, the same in the defendant's rail as it is in the patented rail?

“A. It is not.

“Q. 11. In the patented rail is the flange in a vertical line over the web.

“A. Yes.

“Q. 12. In the defendant's rail is the flange in a vertical line over the web?

“A. No.

25 “Q. 13. Then in this respect is the relative location between the web and the flange the same in the defendant's rail as it is in the patented rail?

“A. No.”

If, therefore, the patent is to be limited to the form that results from having “the web E located relatively to the flange A and head B, as described,” it would seem to follow that there is no infringement by the defendant's rail.

The relative location between the web, the head and the flange is made—by the fifth claim—a material part of the form of the patented rail, as distinguished from the prior state of

the art; and in connection with the offset C, constitutes the "Improvement in street railroad rails" for which the patent was obtained.

When a claim is so explicit the courts cannot alter or enlarge it. If the patentee has not claimed the whole of his invention, and the omission was the result of inadvertence, he should have sought to correct the error by a surrender of his patent and an application for a re-issue. He cannot expect the courts to wade through the history of the art and spell out what he might have claimed, but has not. "Since the act of 1836, the patent laws require that an applicant for a patent shall, not only by a specification in writing, fully explain his invention, but that he shall particularly specify and point out the part, improvement or combination which he claims as his own invention or discovery. This provision was inserted in the law for the purpose of relieving the courts from the duty of ascertaining the exact invention of the patentee by inference and conjecture, derived from a laborious examination of previous inventions, and a comparison thereof with that claimed by him. This duty is now cast upon the Patent Office. There his claim is, or is supposed to be, examined, scrutinized, limited and made to conform to what he is entitled to. If the office refused to allow him all he asks, he has an appeal. But the courts have no right to enlarge a patent beyond the scope of its claim as allowed by the Patent Office, or the appellate tribunal to which contested applications are referred. When the terms of a claim in a patent are clear and distinct, as they always should be, the patentee, in a suit brought upon the patent, is bound by it. *Merrill vs. Yeomans*, (*ante*, 235.) He can claim nothing beyond it. But the defendant may at all times, under proper pleadings, resort to prior use and the general history of the art to assail the validity of a patent or to restrain its construction. The door is then opened to the plaintiff to resort to the same kind of evidence in rebuttal; but he never can go beyond his claim. As patents are produced *ex parte*, the public is not bound by them, but the patentees are. And the latter cannot show that their invention is broader than the terms of their claim; or, if broader, they must be held to have surrendered the surplus to the public."

*Keystone Bridge Co vs. Phoenix Ins. Co.*, 95 U. S. 278.

See also *Railroad Co. vs. Mellon*, 104 U. S., 118.

*Sargent vs. Hall Safe and Lock Co.*, 114 U. S., 86.

*Western Electric Co. vs. Ansonia Co.*, 114 U. S., 452.

*Clark vs. Beecher M. Co.*, 115 U. S., 86.

*Yale Lock Co. vs. Greenleaf*, 117 U. S., 588.

2. The contention of defendants—with reference to the defense of non-patentability—is, “that the complainant’s patent is absolutely void, for the reason that it is only for one especial form of the well known girder rails and that such especial form did not develop any new or unknown mode of operation.”

27 It is undoubtedly true, as has often been said, that no more difficult task can be imposed upon the Court in patent cases, than that of determining what constitutes invention, and of drawing the line of distinction between the work of the inventor and the constructor. It is very often difficult to determine what degree of improvement takes a case out of the mere exercise of mechanical skill and judgment and places it within the domain of invention or discovery. Certain well defined general principles have, however, from time to time, been announced in plain, clear and distinct terms, which are calculated to materially aid the courts in deciding cases of like character with the cases under consideration.

The Supreme Court “has repeatedly held that, under the Constitution and the Acts of Congress, a person, to be entitled to a patent must have invented or discovered some new and useful art, machine manufacture, or composition of matter, or some new and useful improvement thereof, and that ‘it is not enough that a thing shall be new, in the sense that in the shape or form in which it is produced it shall not have been before known, and that it shall be useful, but it must, under the Constitution and the statute, amount to an invention or discovery.’” *Hill vs. Wooster*, 132 U. S., 700. “The cases on this subject are collected in *Thompson vs. Boissilier*, 114 U. S., 1, 11, 12, to them may be added *Stephenson vs. Brooklyn Railroad*, 114 U. S., 149; *Yale Lock Co. vs. Greenleaf*, 117 U. S., 544; *Gardner vs. Herz*, 118 U. S., 180; *Pomaco Holder Co. vs. Ferguson*, 119 U. S., 335; *Hendy vs. Miners Iron Works*, 127 U. S., 370, 375; *Holland vs. Shipley*, 127 U. S., 396; *Pattee Plow Co. vs. Kingman*, 129 U. S., 294; *Brown vs. District of Columbia*, 130 U. S., 87; *Day vs. Fairhaven and Westville Railway Co.*, 132 U. S., 98; *Watson vs. Cincinnati, Indianapolis, etc., Railway Co.*, 132 U. S., 161; *Marchand vs. Enken*, 132 U. S., 195; *Royer vs. Roth*, 132 U. S., 201.

In the light of these principles the facts in these cases as shown by the evidence, must be applied and considered in order to enable the Court to determine upon which side of the border line the patent falls.

The prior art is represented by the ordinary **T**-rail and the California street rail. Neither of these rails possessed all the advantages of the patented rail. In fact the object of the patentee in changing the form of the rail—as stated in his speci-

fications heretofore quoted—was to secure in one form all the advantages possessed by the rails then in public use. The general features of his invention were admitted to be old and he therefore disclaimed the same and confined himself “to the form hereinafter particularly described and claimed as new.”

The advantages testified to by complainant’s witness, Breevort, that the patent rail “is adapted to be placed on a sleeper below the street level so that the paving can be brought up to it—it has a head for the bearing of the wheel, a flange which permits ordinary street traffic, a vertical web and foot,” were all possessed by the California street rail.

Speaking of the California street rail, the witness said: “The said rail has not got the same disposition of metal or the same combination of parts as claimed in the fifth claim of the patent. It is true that the sample of rail shown me has a head, a flange, a web, and a foot, but these parts are differently shaped and are differently located in regard one to the other, when compared with either the defendant’s or the complainant’s rail. The rail

shown me has an offset under the head, and if such a  
29 rail, was used with fish-plates, one set of fish-plates would have to be used for the side of the rail on which the head was turned, and another and narrower set of fish-plates would have to be used for that side of the rail on which the flange is turned. Both in the defendant’s and complainant’s rail, the offset under the head enables fish-plates of like size to be used on both sides of the rail, besides furnishing strength to the head. In the sample of rail shown me, strength for the head has been obtained by a different disposition of metal, and the offset has been dispensed with.”

The flanged rails are shown by the testimony of both parties to be advantageous, by reason of their adaptability for street paving. The California street rail is a flanged rail and in this respect it was an improvement upon the T-rail. This advantage is secured in the form of the patented rail. The advantage of even fish-plating in the patented rail was obtained by the use of the offset C, and this is the most prominent feature upon which the invention of the patented rail is claimed. The form of the California street rail did not admit of even fish-plating. The old T-rail, however, had that advantage. Its form was such as to allow even fish-plating. The rails were even on both sides and the plates could be transferred from one side to the other and only one size of plates were required to be purchased. It will thus be seen as stated by complainant’s witness, Breevort, that “the patent of Johnson described an improved form of rail, intended principally for use in streets for car service and street railway service. The said rail described in the patent is designed to present many of the advantages of the T-rail

30 and possessing also some of the advantages of the ordinary tram-rail." The change in the form of the rail so as to secure these advantages, as shown by the evidence, was, in my opinion, the result of ordinary mechanical skill, which did not require the exercise of the inventive faculty of the mind.

In *Busell Trimmer Co. vs. Stevens*, the Supreme Court, in passing under a similar question involved in that case, said:

"Effort was made to show by other witnesses that the features in the Orcutt patent, specified in the statement of counsel above quoted, are all patentable novelties, especially the combination of them into one devise. We repeat, that in view of the previous state of the art we think otherwise. The evidence, taken as a whole, shows that all of those claimed elements are to be found in various prior patents—some in one patent, and some in another, but all performing like functions in well-known inventions having the same object as the Orcutt patent, and that there is no substantial difference between the Brown metal cutter and Orcutt's cutter, except in the configuration of their molded surface. That difference, to our minds, is not a patentable difference, even though the one cutter was used in the metal art, and the other in the leather art. A combination of old elements, such as are found in the patented device in suit, does not constitute a patentable invention." 137 U. S., 433.

The changes made by Johnson in the form of the rail were changes of degree only, and did not involve any new principle. It was a combination of old elements into a new form without producing any new mode of operation. It is, as was said by the Supreme Court in *Burt vs. Evory*, 133 U. S., 358, "a mere

31 aggregation of old parts with such changes of form or arrangement as a skillful mechanic could readily devise—the natural outgrowth of the development of mechanical skill as distinguished from invention. The changes made—in the construction—were changes of degree only and did not involve any new principle—performed no new function."

In *Florsheim vs. Shilling*, 137 U. S., 77, the Supreme Court adopted the rule announced in *Pickering vs. McCullough*, 104 U. S., 318. "In a patentable combination of old elements all the constituents must so enter into it as that each qualifies every other. It must form either a new machine of a distinct character or function, or produce a result due to the joint and co-operating action of all the elements, and which is not the mere adding together of separate contributions. The combination of old devices into new articles, without producing any new mode of operation, is not invention." *Burt vs. Evory*, *supra*. See also *Hailes vs. Van Wormer*, 20 Wall., 353; *Recken-*



*dorfer vs. Faber*, 92 U. S., 347; *Tack Co. vs. Two Rivers Manufacturing Company*, 109 U. S., 117; *Bussey vs. Excelsior Manufacturing Company*, 110 U. S., 131; *Phillips vs. Detroit*, 111 U. S., 604; *Stephenson vs. Brooklyn Railroad Co.*, 114 U. S. 149; *Beecher M'f'g Co. vs. Atwater M'f'g Co.*, 114 U. S., 523; *Thatcher Heating Co. vs. Burtis*, 121 U. S., 286; *Hendy vs. Miners Iron Works*, 127 U. S., 370. See also *Campbell vs. Bailey*, 45 Fed. R., 564, and authorities there cited.

The contention of defendants is, in my opinion, sustained, and complainant's bills must be dismissed. It is so ordered.

(Endorsed:) Opinion read in open Court July 27, 1891. L. S. B. Sawyer, Clerk.

32 *Deposition of Henry L. Brevoort.*

U. S. Circuit Court, Northern District of California.

JOHNSON COMPANY	}	In Equity.
<i>vs.</i>		No. 10,394.
SUTTER STREET RAILWAY COMPANY.		

JOHNSON COMPANY	}	In Equity.
<i>vs.</i>		No. 10,393.
PACIFIC ROLLING MILLS COMPANY.		

Testimony taken on behalf of complainant in above entitled causes before R. G. Monroe, Notary Public, special examiner, at his office, No. 140 Nassau St., New York, N. Y., April 29th, 1890.

Present: Geo. J. Harding, Esq., for complainant; M. A. Wheaton, Esq., for defendant.

It is stipulated that R. G. Monroe act as special examiner in these causes, and that the testimony taken before him shall have the same force and effect as if taken before a standing examiner of this Court.

It is further stipulated that the proof taken shall be read as taken separately in each suit.

HENRY L. BREEVOORT, a witness called on behalf of the complainant, having been first duly sworn, testified as follows:

Q. 1. What is your name, age, residence and occupation?

A. Henry L. Brevoort; 41 years; Brooklyn, N. Y.; Engineer.

Q. 2. What qualifications have you for testifying in this case?

33 A. As a boy I learned the trade of a machinist and for a number of years owned and operated a machine shop. For the last fifteen or sixteen years I have been almost exclusively

engaged in examining patents and patented devices and I have, during this period, been called upon to testify in suits relating to patents, having testified in many hundred of such cases.

Q. 3. Have you examined and do you understand the letters patent in suit?

A. I have read it and I think I understand what is described and claimed in said patent.

Q. 4. Have you examined certified copy of Complainant's Ex. E, and do you understand the same? I now show you a section of a rail. Please state how said section compares with the drawing, Exhibit E.

A. I have examined the Ex. E and I understand the rail there shown in section. I have compared the section of rail shown me with the said exhibit and I find that the said section is practically the same as the drawing, Exhibit E.

Said section is here offered in evidence and marked "Complainant's Exhibit Section Defendant's Rail."

Q. 5. Please compare Comp'ts. Ex. E and the rail section last offered with the rail set out and described in complainant's patent and specifically pointed out in the fifth claim thereof and state wherein you find similarity or identity of structure between said exhibit and rail section and the patent in suit?

A. I have made the comparison called for in the question between the patent in suit, No. 272,554, dated Feb. 20th, 1883, and granted to Tom L. Johnson, and the rail marked Ex. E, and also the section of the actual rail, and I think that  
34 the said defendant's rail contains the invention of the fifth claim of the patent in suit. I will give my reasons for this opinion.

(Defendant objects to the answer so far given and also the answer the witness proposes to give in so far that it contains the opinion of the witness as to what invention is or is not described in or covered by said claim five, upon the ground that the same is giving a construction of the claim by the witness, and it is therefore incompetent testimony.

Defendant here also puts in an objection to all opinions of the witness which may be hereafter given as to what invention or inventions are or are not covered by any of the respective claims of the patent, upon the ground that the same is incompetent testimony, for the reason that they give a construction to the patent and its claims, and thus trench upon the exclusive province of the Court. This objection is put in here to apply to all such testimony for the purpose of saving a constant repetition of the objection).

The patent of Johnson describes an improved form of rail intended principally for use in streets for car service or street rail-

way service. The rail described in the patent is designed to present many of the advantages of the T-rail and possessing also some of the advantages of an ordinary tram-rail. By making the rail deep like the T-rail ordinarily used on steam roads; the support of the rail can be placed below the street level and the paving can be brought close up on either side to the rail, and above the supporting sleeper.

The rail is also made stiff and ridged by its depth of flange. The rail of the patent is one having a head (lettered B in the patent) which is to be placed in laying the rail slightly  
35 above or level with the surrounding street surface.

There is a flange A which may be just below the street level and which prevents the wheels of ordinary vehicles to find a track between the heads of the rails composing the road. The head and flange are carried by the web marked E in the patent, located below the junction of the head and flange. This web terminates at its base in a foot, D, which is adapted to run upon and be spiked to this sleeper, upon which the rail is laid. Under the head there is an offset marked in the patent, C, which serves to strengthen the rail and which evens up the two sides of the rail so that the fish plates used with the said rail may be alike for both of its sides. The patent says as follows: "The web E extends from the foot D to the angles respectively  
"formed on opposite sides by its union with the offset C and  
"flange A, thus securing a uniform depth of web, proper for  
"the fish-plates to clamp." By disposing the metal in this way in the rail the maximum strength is obtained with the least amount of metal and the metal is so disposed as to produce the most efficient rail that can be produced with the metal used. The patent points out that one of the advantages of the rail section there shown is that substantially equal masses of metal are contained in the head, the flange and foot, and that this disposition of the metal possesses advantages in rolling. The fifth claim refers to a combined tram and T-rail, having a web located relatively to the flange, A, and head, B, as described, and having an offset, C, as shown in the patent located under the head. The claim also says that this structure provides a maximum capacity of outside pocket for, I presume, the ballast. The rail is to be provided, as I understand  
36 adapted as is any T-rail for fish-plating; the foot, D, furnishing a rest for the fish-plates at the lower edge. There is much in the patent relating to the relationship of the rail and the ballast, which may or may not be true. I am unable to state the facts in this regard as they could only be ascertained by a series of experiments, which I have not made. Turning now to the defendant's rail, I find that this is a com-

bined tram and T-rail of the same character as the rail of the patent, and intended for the same uses. The rail has a head which is substantially the head of the patent, and it has the flange and the offset under the head, as in the patent, with the web and foot all substantially as shown in the patent. The only difference to which attention need be called between the defendant's and complainant's rail lies in the fact that in the defendant's rail the head emerges into the flange at a point nearer the center of the rail, thus bringing the web under the head of the rail, and not directly below the point where the head merges into the flange. I have made two diagrams, one of the defendant's rail and the other of the rail of the patent, both being in cross-section, and I have divided this diagram up into five divisions each way, using the extreme dimensions of the rail in both directions as a basis. This leaves two diagrams divided in small parallelograms, each containing a portion of the rail section. Now, by comparing the respective squares which occupy a like portion in the diagrams, it will be seen at a glance that the rails are of almost identically the same section, with one exception, that I pointed out, to wit, that in the defendant's rail the head has been carried slightly to the right and the web has been carried slightly to the left.

37 The defendant's rail possesses all the advantages of the rail of the patent. It is adapted to be placed on a sleeper below the street level so that the paving can be brought up to it; it has a head for the bearing of the wheel, a flange which permits ordinary street traffic, a vertical web and foot, and an offset under the head for giving strength to the rail and which offset makes the two sides of the rail alike, so that fish-plates of the same size can be used. The defendant's rail also has the same maximum capacity of outside pocket as has the defendant's rail, and though the force of the particular advantage does not impress me, the defendant's rail, nevertheless, contains it. I do not think that the moving of the head and web, relatively, to the extent shown, makes any substantial or material difference. In my opinion the defendant's rail, as illustrated by the exhibits before me, is a rail containing the construction of parts specified in the fifth claim of the patent in suit. Complainant's counsel offers in evidence the diagram and requests the examiner to mark the same "Com'ts Ex. Breevoort Diagram."

Q. 6. Please look at the section of rail which I now show you and state whether the said rail structure is similar or dissimilar to the structure set out in the patent in suit and the rail Compt's Ex. E, and Compt's Ex. "Section Defendant's Rail."

A. I have examined the rail shown me. The said rail has not got the same disposition of metal or the same combination

of parts claimed in the fifth claim of the patent. It is true that the sample of rail shown me has a head, a flange, a web and a foot, but these parts are differently shaped and are  
 38 differently located in regard one to the—when compared with either the defendant's or complainant's rail. The rail shown me has no offset under the head, and if such a rail was used with fish-plates, one set of fish-plates would have to be used for the side of the rail on which the head was turned and another narrower set of fish-plates would have to be used for that side of the rail on which the flange is turned. Both in the defendant's and complainant's rail, the offset under the head enables fish-plates of like size to be used on both sides of the rail besides furnishing strength to the head. In the sample of rail shown me, strength for the head has been obtained by a different disposition of the metal and the offset has been dispensed with; I think the sample shown me is clearly a different rail from the one described in the patent and specifically claimed in the fifth claim thereof, and likewise I think it is substantially a different rail from complainant's or defendant's rail here before me.

The section of rail referred to in witness last answer is offered in evidence and same is marked "Section California Street Rail."

It is admitted by counsel on both sides that the exhibit just marked "Section California Street Rail," correctly illustrates the rail set out in the answer under California St. Railroad prior use and prior patents Nos. 262,126 and 247,781.

Cross-examination by MR. WHEATON.

X.-Q. 7. Why in your direct examination have you quoted claim five of the patent and have not quoted any of the  
 39 other claims?

A. My attention was only called by the question to the fifth claim and consequently I did not consider any other.

X.-Q. 8. In the patented rail is there any part of the head that is over the web in vertical line?

A. No.

X.-Q. 9. In the defendant's rail is the head in vertical line over the web or not?

A. The head is over the web.

X.-Q. 10. Then in the respect referred to in the last two questions, is the relative location of the head and web the same in the defendant's rail as it is in the patented rail?

A. It is not.

X.-Q. 11. In the patented rail is the flange in a vertical line over the web?

A. Yes.

X.-Q. 12. In the defendant's rail is the flange in a vertical line over the web?

A. No.

X.-Q. 13. Then in this respect, is the relative location between the web and the flange the same in defendant's rail as it is in the patented rail?

A. No.

X.-Q. 14. Please describe what a tram-rail is as commonly understood?

A. It is a flat rail having a head and flange and no web, and is adapted for being laid on longitudinal stringers; the bottom of the rail is flat.

X.-Q. 15. How long to your knowledge has the ordinary **T**-rail been in use in combination with fish-plates on ordinary steam railroads?

40 A. I don't know the date exactly. It must be about twenty years ago, perhaps more.

X.-Q. 16. How does the form of the web and the projections from it on both sides, both at its upper and lower ends of the rail of the patent in suit, compare with the form of the web and the projections from it both at its upper and lower ends, commonly used in the old ordinary **T**-rails referred to?

A. The old ordinary **T**-rails had webs that merged into the head and foot by curves of small radii just as in the patent in suit but in such rails the head was symmetrical on both sides and there was no offset like C, and no flange like A.

X.-Q. 17. Is there any difference between the form of the fish-plates mentioned in the patent and the form of the web to which they are to be attached shown in the patent, or in the method of attaching such fish-plates to such web from the form of the fish-plates and webs and methods of attaching them together which were in common use on ordinary steam railroads. If so, please describe in what such difference or differences consist?

A. There are no differences.

X.-Q. 18. Are there any differences between the head and flange of the rail shown in the patent and the head and flange of some of the tram-rails which were in public use long prior to 1880. I refer to the top surface of the patented rail only?

A. I have no special rail in mind, but I dare say that old tram-rails could be found whose top surface would be the same.

X.-Q. 19. In view of the fact that the old California street rail had a web and foot attached to a head and flange which, as to its upper service might have corresponded with some of the forms of the upper surfaces of ancient tram-rails, and in  
41 view of the further fact that the use of rails in which the webs were alike upon both sides and with which

fish-plates precisely alike were used upon both sides were common on steam railroads. Will you please describe if you can, how there could possibly be any invention in attaching such webs and fish-plates to any other tram-rail having a somewhat different shape and form to its upper surface?

A. I do not think that the invention consisted in the application of fish-plates to the rail of the patent. The invention consisted of the general conformation of the rail having the head, the flange and offset, the whole forming with its web and foot a very desirable form of rail, and one of the advantages of the form is that it admits of even fish-plateing on both sides, while a strong and rigid rail is got with a minimum of metal or rather with the metal located in the best possible way.

X.-Q. 20. Will you please attach a section of fish-plates to the exhibit marked Complainant's Exhibit Section of Defendant's Rail so as to show the connection of the fish-plates and rail?

A. I have made the attachment to said exhibit.

HENRY L. BREVOORT.

Sworn and subscribed to before me this 29th day of April, 1890.

[SEAL.]

ROBERT GRIER MONROE,  
*Notary Public,*  
*New York Co.*

*Certificate to Deposition.*

42 STATE OF NEW YORK, }  
City and County of New York, } ss.

I, Robert Grier Monroe, a Notary Public in and for the City and County of New York, State of New York, do hereby certify that the foregoing deposition of Henry L. Brevoort was taken before me on behalf of the Johnson Company, the complainant in two civil causes in the Circuit Court of the United States for the Northern District of California, on the equity side of said Court, wherein the Johnson Company is complainant and the Sutter Street Railway Company and the Pacific Rolling Mills Company respectively defendants, in actions for infringement of a patent; that said deposition was taken in pursuance of notice; that the reason for taking said deposition was and is, and the fact was and is, that said deponent lives at a greater distance from San Francisco, the place of trial of the said actions, than one hundred miles, to wit: In the City of New York, State of New York; that said deposition was taken at my office, No. 140 Nassau street, in the City and County of New York, on the 29th day of April, 1890; that said deponent was by me duly cautioned and sworn to testify the whole truth before the

commencement of his testimony; that the testimony of said witness was reduced to writing by me and by no other person, and that said witness subscribed his testimony after it had been so reduced to writing; that the complainant was represented by George J. Harding, Esq., of counsel, and the respondents by M. A. Wheaton, Esq., of counsel; that the entire testimony was commenced and concluded on the same day, to wit:

43 On the 29th day of April, 1890.

In testimony whereof, I have hereunto set my hand and affixed my seal of office at the city of New York, County and State of New York, this 5th day of May, 1890.

[SEAL.]

ROBERT GRIER MONROE,

*Notary Public N. Y. Co.*

(Endorsed:) Depositions opened by consent, Aug. 27, 1890. G. J. Harding for Complainant, M. A. Wheaton, for Respondents. Opened by agreement and re-filed August 27, 1890. L. S. B. Sawyer, Clerk, by F. D. Monckton, Deputy Clerk.

44 *Exhibit "Drawing of Complainant's Exhibit E."*

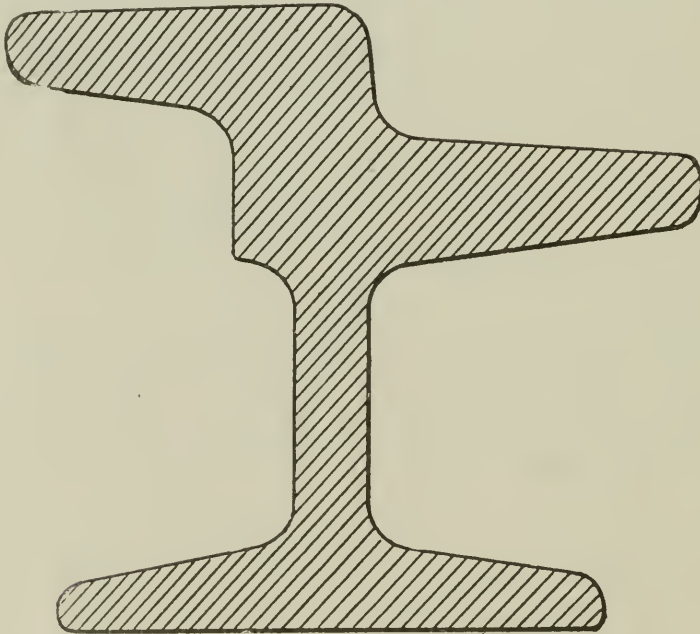

I certify that the above is a true and correct tracing of a drawing introduced in evidence and marked "Complainant's Exhibit E," in the case of the *Johnson Company vs. Sutter Street Railway Company*, in the U. S. Circuit Court for the Northern District of California.

(Signed)

S. C. HOUGHTON,

*Examiner in Chancery of said Court.*

(Endorsed:) Opened by agreement and re-filed August 27, 1890. L. S. B. Sawyer, Clerk. By F. D. Monckton, Deputy Clerk.



45

*Complainant's Exhibit Brevoort Diagram.*

Defendant's Rail, Figure 1.

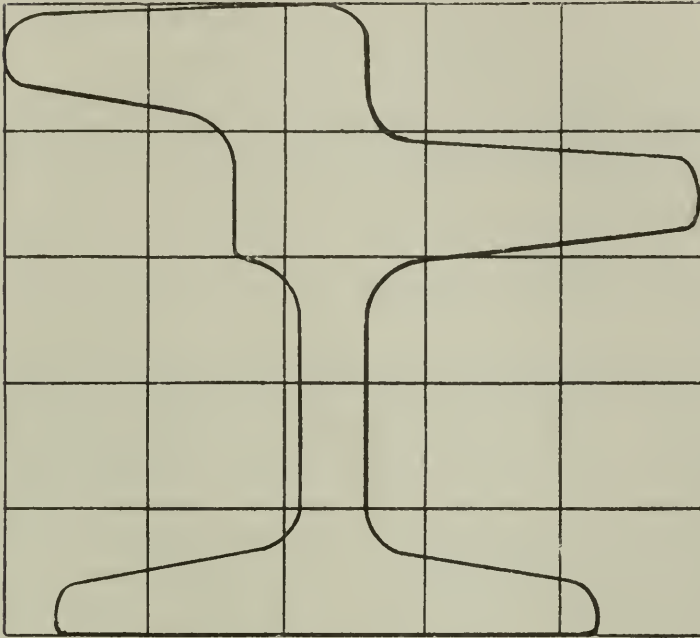

Patented Rail, Figure 2.

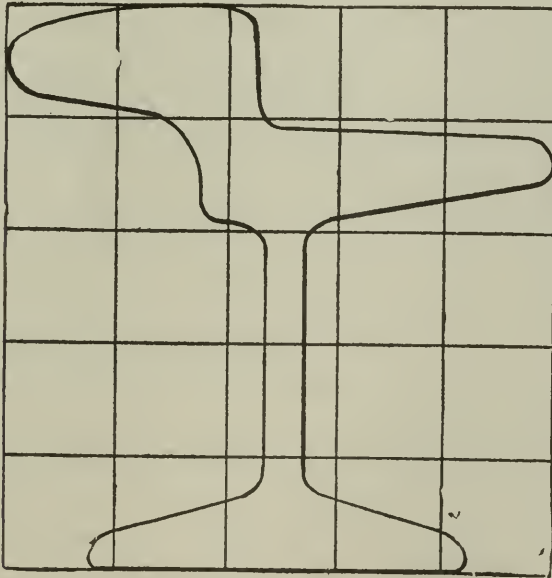

U. S. Circuit Court, N. D. of California.

JOHNSON Co. }  
 vs. } No. 10,394.  
 SUTTER ST. RY. Co. }

JOHNSON Co., }  
 vs. } No. 10,393.  
 PACIFIC ROLLING MILLS Co. }

*Complainant's Ex. Brevoort Diagram.*

R. G. MONROE, *Exr.*, April 29, 1890.

(Endorsed:) Opened by agreement and re-filed August 27, 1890. L. S. B. Sawyer, Clerk. By F. D. Monckton, Deputy Clerk.

46

*Caption to Deposition.*

In the Circuit Court of the United States for the Ninth Judicial Circuit in and for the Northern District of California.

THE JOHNSON COMPANY, Complainant,	}	In Equity. No. 10,394.
<i>vs.</i>		
SUTTER STREET RAILWAY COMPANY, Respondent.		

Be it remembered, that, on the seventh day of November, A. D. 1889, and on the several days thereafter to which the examination was regularly adjourned, as hereinafter set forth, at my office, room 57, in the United States Appraisers' Building, on the northeast corner of Washington and Sansome streets, in the City and County of San Francisco, State of California, before me, S. C. Houghton, Examiner in Chancery, of the Circuit Court of the United States for the Ninth Circuit and Northern District of California, personally appeared the several witnesses whose names are hereinafter set forth, who were produced and examined on behalf of the respective parties to the above entitled cause.

W. F. Booth and G. J. Harding, Esq., appeared as counsel on behalf of complainant, and M. A. Wheaton, Esq., as counsel on behalf of respondent.

Following is a record of the proceedings:

47

*Deposition.*

THURSDAY, *November 7th*, 1889.

Present: Mr. Booth, of counsel for complainant; Mr. Wheaton, of counsel for respondent.

(Complainant introduces in evidence copy, duly certified by the Commissioner of Patents of the United States, of United States Letters Patent No. 272,554, granted February 20th, 1883, to Tom L. Johnson, for improvement in street railroad rail. Marked "Complainant's Exhibit A.")

(It is agreed by counsel for both complainant and respondent herein that the certified copy of the patent, "Exhibit A," may be withdrawn upon the substitution in place thereof of a Patent Office copy of the specifications and drawings of said patent.)

(Complainant also introduces in evidence like certified copy of assignment, dated the ninth day of \_\_\_\_\_, 1883, conveying all rights under the patent "Exhibit A" from Tom L. Johnson, the patentee, to Johnson Steel Street Rail Company. Marked "Complainant's Exhibit B.")

(It is agreed by counsel for both complainant and respondent herein that the certified copy of the assignment, "Exhibit B," may be withdrawn upon the substitution in place thereof of copy certified by the Examiner to be correct.)

(Complainant also introduces in evidence copy, certified by the Clerk of the Jefferson County Court, Kentucky, of the articles of incorporation of the Johnson Steel Street Rail Company, a corporation organized under and by virtue of the laws of Kentucky, and also of the amendments to said articles of incorporation whereby the name of said corporation is  
48 changed to that of "The Johnson Company." Marked "Complainant's Exhibit C.")

(It is agreed by counsel for both complainant and respondent herein that the certified copy of the articles of incorporation, and amendments thereto, "Exhibit C," may be withdrawn upon the substitution in place thereof of copy certified by the Examiner to be correct.)

(Complainant also introduces in evidence section of street rail. Marked "Complainant's Exhibit D.")

(Complainant also introduces in evidence sectional drawing representing the rail "Exhibit D." Marked "Complainant's Exhibit E.")

(It is admitted as a fact by both complainant and respondent herein that the Sutter Street Railway Company, respondent herein, caused railway rails like that shown by the rail section and sectional drawing thereof, Complainant's Exhibits "D" and "E," respectively, to be manufactured by the Pacific Rolling Mills Company of San Francisco, California, and that it, the said respondent, used the said rails in the City and County of San Francisco, State of California, after the 20th day of February, 1883, and before the 4th day of June, 1889, the date of commencement of this action.)

(Examination continued, by agreement of counsel, subject to agreement and notice.)

49 SATURDAY, August 23d, 1890.

Present: Mr. G. J. Harding, of Counsel for Complainant.

This day was set apart for taking testimony herein, at the request of counsel for complainant.

No counsel on the part of respondent, and no witness appearing, the examination is continued at the request of counsel for complainant until Monday, August 25, 1890, at half past ten o'clock, A. M.

MONDAY, August 25, 1890.

Present: Mr. G. J. Harding, of Counsel for Complainant.

(Examination further continued, in conformity with agree-

ment of counsel, until Tuesday, August 26, 1890, at half past ten o'clock A. M.

TUESDAY, August 26, 1890.

Present: Mr. G. J. Harding and Mr. Booth, of Counsel for Complainant, Mr. Wheaton, of Counsel for Respondent.

(Examination further continued, in conformity with agreement of counsel, until Wednesday, August 27, 1890, at two o'clock P. M.

WEDNESDAY, August 27, 1890.

Present: Mr. Harding and Mr. Booth, of Counsel for Complainant, Mr. Wheaton, of Counsel for Respondent.

50

*Deposition of Patrick Noble.*

Examination-in-chief of PATRICK NOBLE, on behalf of respondents.

By Mr. WHEATON:

Q. 1. State your name, age, place of residence and occupation.

A. My name is Patrick Noble, my age forty-one years. I reside in San Francisco, and am by occupation Superintendent of the Pacific Rolling Mills.

Q. 2. Have you read the specification and drawings of the complainants' patent sued on in this case, and do you understand them?

A. I have read them, and understand them.

Q. 3. How many of the cable street-railroads in this city have used girder rails with the web and foot of the ordinary T-rails?

A. I think all—all, except the Clay Street and Sutter Street up to this time. The Sutter Street now uses it; so I think the Clay Street is the only one—No, there are three roads that do not use them: the Clay Street, the Geary Street, and the Union Street.

Q. 4. What kind of a rail was put on the Clay Street road when it was first built?

A. Well, it was a T-rail-girder rail.

Q. 5. What was the difference between that rail, as to shape, and the ordinary T-rail.

A. Of which, the Clay Street?

Q. 6. Yes.

A. It was an ordinary T-rail.

Q. 7. Now listen to the question I asked you a moment ago, as to how many of the cable street roads use girder rails with the web and foot of an ordinary T-rail, and see whether you understood it.

(Q. 3 repeated.)

A. My answer was, all except three. Now, you want me to enumerate them?

Q. 8. No. I cannot understand why you make an exception of the Clay street road?

A. I ought not to have done so in the case of the Clay Street Railroad. I had my mind on the patent rail. It was a girder rail that was used. I should have said that all the cable roads in this city, except two, used such rails, those two being the Union street and the Geary street roads.

Q. 9. Which was the first cable road built here?

A. The Clay street.

Q. 10. When was that built?

A. Well, I don't remember exactly. It was somewhere about 1877.

Q. 11. Wasn't it set running in 1873?

A. No, I don't think so. I don't know. I don't recollect.

Q. 12. Which was the next cable road built after the Clay street, in this city?

A. My recollection is that it was the California street road. I am not exactly certain, but it was either the California street or Sutter street. I think the California street was prior.

(The following are admitted as facts in this case by both complainant and respondent, namely:

That the Clay Street Cable Road commenced operation in San Francisco in the year 1873.

52 That the Sutter Street Cable Road commenced operating in 1876;

That the California Street Cable Road commenced operating in San Francisco in 1878;

That the Geary Street Cable Road commenced operating in San Francisco in 1880.)

Q. 13. Please look at this section of the defendant's rail, "Exhibit D," and state what the differences are, if any, between that rail and the rail shown in the patent sued upon?

A. This "Exhibit D" has a straight bearing for the wheel, and we avoid, as a disadvantage, the curve which the complainant claims in his patent is an advantage.

Q. 14. Does your last answer refer to the curve on the top of the head of the rail on which the tread of the wheel runs?

A. Yes, sir.

Q. 15. Please explain why you consider that curve shown in the patent to be a disadvantage?

A. A street railroad in San Francisco would not accept of a rail of that construction, because it would wear out the wheels too fast, and also the rail.

Q. 16. How much surface for the head of the wheel that

would be practically level do the railroads require for the tread of the wheel to run on?

A. From an inch and three-quarters to two inches, in this city. The complainant's rail is about half an inch.

Q. 17. Half an inch of what?

A. The bearing for the wheel. That would not be salable in this city—that is, so far as the head is concerned.

Q. 18. Has there ever any rail been used in this city, or made by your company, having the curvature on the surface of the head which is shown in the patent?

A. No. Every rail of the girder shape has to have a slight taper in order to clear the roll—come out of the groove in the rail. But we make the top of the head of the rail as nearly straight across as mechanical difficulties will permit in rolling. This rail is rolled upon its side, and in rolling the head of the rail, if it was absolutely straight it would not clear the roll, and we make it as nearly straight as possible in order to clear the roll, and avoid the complainant's curve, which we think to be a defect.

The next point of difference is that we make the head of the rail as much over the web as possible, in order to make the rail a balanced rail. The complainant's rail, with the head outside the center line, is directly opposite to what he claims—an unbalanced rail. We so construct a rail as to put the weight of the car on the center line, and the complainant throws it back, giving it a tendency to spread the tracks. I think those are the two most prominent differences in the rails. We have, in fact, adopted his dotted line for the head of the rail, which he is avoiding. He, in his claims, claims that the dotted line is not a good section, and so, in order to get his patent, he adopts the black line. Now, we adopt the dotted lines on our section, nearly, without needing anything about this patent at all. It is simply a question of mechanics.

Q. 19. In your last answer do you refer to the lines in "Fig. 4" of the patent?

A. Yes, sir. As to the dotted line below the head, he claims that he changes it from the "j L g" line to the "j h g" line, in order to give a better pocket for sand, gravel, or macadam, affording a backing to his rail; and that shape never was made that I know of. We never made it.

Q. 20. Which shape was never made?

A. The shape represented by the "j L g" line. It assumes a deceptive which has never been used.

Now, in reference to the offset "C," he claims that by using that offset he affords a greater pocket capacity for the packing of sand, macadam or gravel. We put it on ours simply to make the two fish-plates equal. As a pocket to receive sand,

gravel or macadam, it is a defect, it is an obstruction to the packing as it comes in. If the curve "j h" were continued around in a true curve it would afford a better pocket. So, in that respect, we look upon that offset "C" as a defect.

I will make another statement here, from what I see in the claims of the patent. He claims that the making of this rail in this peculiar shape, the combination of the head "B," the flange "A," and the foot "D"—that he distributes his metal in such a way as to do away with the necessity of cambering or curving while it is hot, during rolling. In our rail we have it put at four or five inches to the camber or curve because the distribution of the metal in our rail makes the foot cool faster than the head, and it is necessary while it is hot to bring it on a curve with the foot, on the inside of the curve, so that the head cooling slower and later, it draws it straight almost. Now, the cambering is simply a part of the process of straightening the rail, and only a part. It is easier while the rail is hot to put the cambering in, and the cooling brings it to a straight line. The balance of the process is carried out when it is cold.

55 Q. 21. The balance of the process of straightening?

A. Yes. The cambering is part of the process of straightening. In the specification of the patent it says: "All necessity of cambering in the rolling of said rail is therefore obviated, and if the rail be delivered straight and true from the rolls, then it will remain perfectly straight and uncurved when cold." Well, I know that we have never, and I don't think any mill in the world has ever delivered a rail to put down on a surface. It has got to go through the process of straightening, either when hot or when cold. We do part of ours when hot and part of it when it is cold. This rail marked "Exhibit D" required more camber than any rail we have ever made; so that in that respect complainant's claim does not touch us at all.

Referring to the arrangement set out in Claim 5 of the patent, we arrange the relative position of head, flange and web entirely different from the patentee. To go back to this claim: "Another peculiarity of this rail is that the head, flange, web and foot are substantially of equal mass of material." This is not making a comparison, but his head, web and flange are not an equal mass of material. The preponderance is with the head and flange. I am calling attention to that in reference to the heating and cooling off, the contraction in cooling. His rail will require cambering also. That is why I call attention to that. The mass of metal above the web is so much greater than the mass below the web that the cooling will not be equal in the complainant's rail; and that is self evident.

Another peculiarity of the figures that he gives is that he connects all the comparisons of the rails that he desires to patent with an old tram-rail, entirely ignoring the fact that a girder rail had been made years before (referring to Figures "2" and "3" of the patent sued on.) If he had taken the rail made for the California-street road, which was well known when his patent was taken out, and made a comparison there between his form of rail and the form used on the California-street road, these claims he makes would not have been apparent, and especially the one where he uses the back of the rail as a pocket for the sand, gravel and cement, because the old California-street rail furnishes a better pocket, the offset "C" being an obstruction.

Q. 22. In the defendant's rail is the web located relatively to the flange, "A," and head, "B," as described in the patent?

A. As I have said, no.

Q. 23. In that respect, how does the relative location of the web, head and flange compare in the defendant's rail with the relative location of the web, head and flange in the old California-street rail?

A. They are practically the same. That is, the weight of the car comes directly over the web.

Cross-examination PATRICK NOBLE.

By Mr. HARDING:

X.-Q. 1. What I understand you to say is that your rail is more nearly represented by what is shown in the dotted lines, "d," in "Fig. 4" of the patent sued on. Is that so?

A. Yes; with the exception of the curve on the back side of the head, our head being straight.

57 X.-Q. 2. Now, you are perfectly sure of this? That is, you have tested it beyond that which comes from looking at this "Fig. 4" alone?

A. Having "Exhibit D" and "Fig. 4" of the patent now before me, I see in "Fig. 4" that the dotted line brings the head directly over the web of the rail. In "Exhibit d" it brings it directly over the web of the rail. It is not a matter of opinion, it is before you; and the blank lines in "Fig. 4" brings the head back of the web.

X.-Q. 3. That is, what you contend is that in your rail the head is shoved over as shown by the dotted lines in "Fig. 4" of the drawings of the patent?

A. To a certain degree. I do not admit that the dotted line in that figure is exactly like our head.

X.-Q. 4. But beyond that slope it is; is that what you mean?



A. Yes.

X.-Q. 5. That is, if we take "Fig. 2" of the patent, your web has remained fixed while the head portion of the rail has been pushed laterally?

A. I don't know exactly how to express it that way. What I mean is that our web is directly under our head, and that your web is absolutely out from under your head. The difference is very marked.

X.-Q. 6. Yes, but you don't understand my question. Now, take "Fig. 2" of the patent; you mean to say, do you, that your rail differs from the patented rail in that while the web stands where it is, as exhibited in "Fig. 2," the portion above the web is moved laterally, always excepting, of course, the top line of the head?

58 A. Always excepting that neither the head, the web, or flange, are alike. The fact is that you make me except to the whole thing.

X.-Q. 7. (X.-Q. 6 repeated.)

A. That will conform somewhat to it, but I don't mean to say that it is absolutely so. It will conform to it. Of course, if you move it, taking "Fig. 2" at the letter "R," why you would do away with the offset, and so that wouldn't be so, you see. Your question is not a practical one. The only way to make the question practical is to put our rail down on your rail, and then you will see what the difference is.

X.-Q. 8. Then, as a matter of fact, Mr. Noble, the best way of finding out whatever difference exists between the patented rail and your rail is to put one on the top of the other?

A. I didn't say that. I said if you wanted to make me draw lines I would put one on top of the other, and then I know I would have mine correct. No, I differ with you. The best way is to state that our head is straight, and has not got a backward declination, and that our web is over the head, and yours is not, in either case.

X.-Q. 9. Now, after all, that is the best way to point out the differences, just as you state now?

A. I think so.

X.-Q. 10. There is no use of mixing it up with dotted lines, or anything of that kind. What you stated in your last answer but one is as fair a way for anybody to understand it as any, isn't it; if not, say not?

A. I think that points out the difference exactly. I will say further, that if I wanted to show the difference between these two rails to an untechnical mind I would take the patent  
59 rail here as represented in the patent, of the same weight and all, preserving the same proportions as he has got it. Mine is a heavy rail, and his is a very light one, you see;

and I would draw my rail over that in a different colored ink, and that would show the thing to a dot. That is what you ought to have.

X.-Q. 11. That is what I state: the best way to do so is to put one rail, or the drawing of one rail on top of the drawing of the other.

A. Making the weights per yard the same.

X.-Q. 12. Making them even exactly?

A. Yes. If you put "Exhibit D" on "Fig. 2," it misleads you, because there is so much difference in the scale.

X.-Q. 13. Now there is no question but what you have an offset on your rail, is there?

A. At "C." We have an offset at "C," in "Fig. 2."

X.-Q. 14. In your rail?

A. We have an offset corresponding to the offset "C," shown in the patent, but it is for the purpose of making the fish-plates equal, only.

X.-Q. 15. Now, you cannot even fish-plate on this California Street rail, can you?

A. No; we use a fish-plate on it.

X.-Q. 16. And you can even fish-plate on your Sutter Street rail, can't you, which is herein alleged to be an infringement?

A. Yes, sir.

X.-Q. 17. This California Street rail, and the Omnibus rail, that you roll, are the only two flanged or girder rails in use in this city, are they not, with the exception of the rail complained of in this suit?

60 A. Yes. I will make an exception of that, of course. We roll numbers of girder rails, but not for street railroad purposes.

X.-Q. 18. They are not flanged?

A. No, sir.

X.-Q. 19. Well, that question was restricted to "flanged"?

A. No; they are not flanged.

X.-Q. 20. Now, in this rail complained of, you have a head which projects to one side of the web, have you not?

A. Partly.

X.-Q. 21. Well, it projects to one side of the rail, doesn't it?

A. Part of the head does—yes. The whole head don't.

X.-Q. 22. Well, the head extends to one side, beyond the web, doesn't it?

A. Yes, sir.

X.-Q. 23. While it does not extend beyond the web on the other side, does it?

A. Well, it does very slightly.

X.-Q. 24. And you have projecting from the other side of the web a tram or flange?

A. Yes.

X.-Q. 25. And you have a web, have not not?

A. Yes.

X.-Q. 26. And you have an offset corresponding to the offset "C," shown in "Fig. 2" of the patent, have you not?

A. I have.

X.-Q. 27. Suppose that offset were removed from your rail, and the line of the curve of the head were carried to its junction with the web, would there be sufficient metal at the point where the tram or flange meets the head to form a safe and practical rail?

A. Yes; more than yours—thirty per cent. more, I should think.

61 X.-Q. 28. More than ours, with the offset and all.

A. Yours is a half an inch, and mine would be within a fraction of three-quarters of an inch, and that would be nearly fifty per cent. more than yours, having the offset.

X.-Q. 29. Did you take the measurement from the point of the offset?

A. I took it at the narrowest point.

X.-Q. 30. You didn't take it, then, from the point of the offset?

A. I took it where it is narrowest.

X.-Q. 31. I ask you, did you take it from the point "g?"

A. I took it from the point where it is narrowest; from the point where it is weakest.

X.-Q. 32. You took your measurements from the drawing of the patent, when speaking of the patent rail, didn't you?

A. Yes, sir.

X.-Q. 33. You stated that you were connected with the defendant company, didn't you, the Pacific Rolling Mills?

A. I am the superintendent, sir. I am the one that makes those rails.

X.-Q. 34. Look at the patented rail. The offset "C" in that patent enables even fish-plating to be used, doesn't it?

A. Yes, sir.

By Mr. BOOTH:

X.-Q. 35. Mr. Noble, in answer to Mr. Wheaton, upon your examination-in-chief, you referred to the dotted lines represented by the letter "d" in "Fig. 4" of the complainant's patent, and stated that your rail more nearly conformed to the section represented by that dotted line which was the very section which the patent stated to be disadvantageous. I will now ask you whether you referred to the matter from lines 60 to 66, inclusive, on page 2 of the specification of the

62 patent?

A. No, I stated, if I recollect, in my answer, that I referred to Claim 5. If I didn't say it this way, it is what I intended to state. I intended to state that the web "E," flange "A" and head "B," were diametrically opposed in our rail to the complainant's, and that the principle was more clearly shown by his dotted line "d"—that it carried out our principle more than his. It is not the conformity that I was speaking of, but the principle.

X.-Q. 36. Did you not state that the patent stated that were the head and flange moved over to the position shown by the dotted line "d" it would be a disadvantage?

A. I don't understand your question.

X.-Q. 37. (X.-Q. 36, repeated.)

A. So far as the principle is concerned, I am not saying that I took the section and moved it over.

X.-Q. 38. (X.-Q. 36, repeated.)

A. I think I said so far as the head was concerned. I think you made the distinction. I made the exception that so far as the head was concerned that dotted line more nearly carried out our principle, and which the complainant said was a disadvantage. Of course that was my recollection of what the complainant claimed was a disadvantage. I am certain that I made the exception that it was only the lines on the head.

X.-Q. 39. Well, do you gain your opinion of what the patent states in that regard from line 60 to 66, inclusive, of page 2 of the specification?

A. I couldn't say whether it was or not, without reading over the whole thing.

63 X.-Q. 40. Well, read the lines, if that is the place?

A. Well, I don't know whether that is where I drew my inference from or not, although that does refer to that very thing, and I think it would be an advantage to do just what he has said, looking at his rail entirely—looking at his section.

X.-Q. 41. "To do just what he has said," what do you mean by that? What do you mean by "to do just what he has said?"

A. What he has said between lines 60 and 66, inclusive; throw this head forward at "d" and keep the offset, "C," intact.

X.-Q. 42: Stationary?

A. Yes, sir; I think it would make a stiffer and a preferable rail.

X.-Q. 43. Do you or do you not do that in your rail?

A. We do that.

X.-Q. 44. That is, you mean to say that you throw your head and flange over and keep your offset stationary?

A. Yes; and thereby gain greater strength.

X.-Q. 45. Mr. Noble, I will show you "Complainant's Exhibit Brevoort Diagram," and you will see that "Fig. 1" represents your rail, and "Fig. 2" represents the rail of the patent. They are on different scales, are they not?

A. Yes, sir.

X.-Q. 46. Do you see the object of the squares in which these rails are delineated?

A. I would take it that it was to show the relative position of the head and flange and web.

X.-Q. 46. Now, looking at those two figures, are not the offsets in the same position?

A. No.

X.-Q. 47. How are they in different positions, if so?

64 A. Well, in the center square it comes up above the web in the defendant's rail, in "Fig. 1;" and in "Fig. 2" it comes below the square into the web.

X.-Q. 48. Acknowledging the correctness of this answer, so far as a vertical plane is concerned, let me refer you to a lateral. Are they not in the same position laterally?

A. They are not. In "Fig. 2," in the vertical line of squares, your web is in the middle of the squares. In "Fig. 1," in the defendant's rail, the web is to the left of the center.

X.-Q. 49. I refer to the offset only.

A. It is the same, with reference to the offset.

X.-Q. 50. Is not the point of the offset in "Fig. 1" the same distance from the left-hand line of the diagrammatic squares as the point of the offset in "Fig. 2" is from the same line, of its diagrammatic squares?

A. Of course you cannot answer that exactly, because they are not on the same scale; but I should say, no.

X.-Q. 51. Are they not, relatively, the same distance from that line?

A. No; you can't say that. The only way to answer that question is as a claim is made in relation to the three parts.

X.-Q. 52. I am only speaking of the offset.

A. The offset is not the same in both. Now, if we scale it, would it be the same? That is a question I cannot answer. We would have to scale it to find out. You might say so, and I would think not, and we would both be pretty near right. We would have to scale it to see?

65 X.-Q. 53. Mr. Noble, if defendant's rail as represented by "Exhibit D" were reduced to the scale or to the same size as the drawing "Fig. 4" in complainant's patent, would the distance from the point of your offset to the junction of head and flange be as great as the distance from the point "g" in "Fig. 4" of complainant's patent to the junction of the head and flange on the dotted line "d"?

A. Well, I couldn't say. We would have to do it to find out. It is one of those things you couldn't tell by your eye. You can't tell that by your eye. It might and it might not be.

X.-Q. 54. Well, what do you think? Give us the best answer you can.

A. Well, that is the best answer I can give, that it might come so, and it might not. I will measure this and see. You see the distance from the point of the offset in "Fig. 4," to the junction of the head and flange, using the dotted line "d," is nine-tenths of an inch, and the distance between the same points on "Exhibit D" is nearly eleven-tenths of an inch, and from that you can see if this rail were reduced it would reduce that distance, and it would then more nearly approach the distance shown on the patent drawing between those points.

X.-Q. 55. Now, if the reduction in the scale were made, as before intimated, do you not think that, from an observation of the defendant's rail and the drawing, that the distance between the points mentioned in the drawing would be greater than the distance between the points mentioned in the rail so reduced?

A. No, I should not; and I can only argue from sight, and that is very deceptive.

66 Re-examination of PATRICK NOBLE.

By Mr. WHEATON:

R.-Q. 1. Were the girder rails which were used on the Clay Street cable road when it first started here, even fish-plated?

A. Yes, sir.

R.-Q. 2. As the defendant's rails have been laid on the Sutter Street cable road, was there ballast used for pavement which filled in the pockets on each side of the rail between the foot and flanges?

A. No, sir; it was laid in stone and concrete; in concrete on the inside, and stone on the outside—basalt rock.

R.-Q. 3. How were those stone blocks arranged in connection with the rail in the pavement?

A. Set square up to the flange and head of the rail, both front and back. That is one of the features of the girder rail, which is its adaptability for paving.

R.-Q. 4. You mean the advantages of the girder rail, or flange and head, is that you can lay those stone blocks up against them?

A. Yes, sir.

R.-Q. 5. As they are used in practice, do the top of the stone paving blocks come up level to the top rail on the street?

A. Yes, on a level with the head; and some put it on the level

of the flange, and some up above, but it is better to have it on a level with the flange.

R.-Q. 6. Was that the way that the rails and paving were laid on the California Street road in 1878?

A. Yes, sir.

By Mr. HARDING:

R.-Q. 7. The rail that you spoke of in use on the Clay Street road is the ordinary T-rail, is it not?

67 A. Yes, sir.

R.-Q. 8. Without flanges projecting from the head at all?

A. No, sir; it had no flanges.

Mr. Wheaton: Defendant rests.

68

*Certificate to Deposition.*

I certify that the foregoing depositions were taken at the place stated in the caption to said depositions, at the several times set forth in said depositions, in my presence, and in the presence of counsel for the respective parties to the cause in said caption, entitled: that, previous to giving his testimony, each of the witnesses in said depositions named was by me duly sworn to tell the truth, the whole truth and nothing but the truth, in said cause; that said depositions were, except in so far as they were taken down in writing by the Examiner, taken down in shorthand writing and transcribed by \_\_\_\_\_, pursuant to stipulation and agreement of counsel; that said depositions, after being so transcribed, were read by, or by me to, the said witnesses, and signed by them, respectively, except in those cases where such reading and signing were, by agreement of said counsel, waived, as in said depositions set forth; and that I have retained said depositions for the purpose of delivering the same with my own hand to the Court for which they were taken.

Accompanying said depositions, and forming part thereof, are the several exhibits introduced in connection therewith, and referred to and specified therein.

I further certify that I am not attorney nor of counsel for any of the parties to said cause, nor in any way interested in the event thereof.

In witness whereof, I have hereunto set my hand, this tenth day of November, A. D. 1890.

S. C. HOUGHTON,

*Examiner in Chancery,*

*U. S. Circuit Court, Northern Dist. of Cal.*

(Endorsed:) Testimony opened and re-filed Nov. 20, 1890.  
L. S. B. Sewyer, Clerk.







T. L. JOHNSON.

STREET RAILROAD RAIL.

No. 272,554.

Patented Feb. 20, 1883.

Fig. 1.

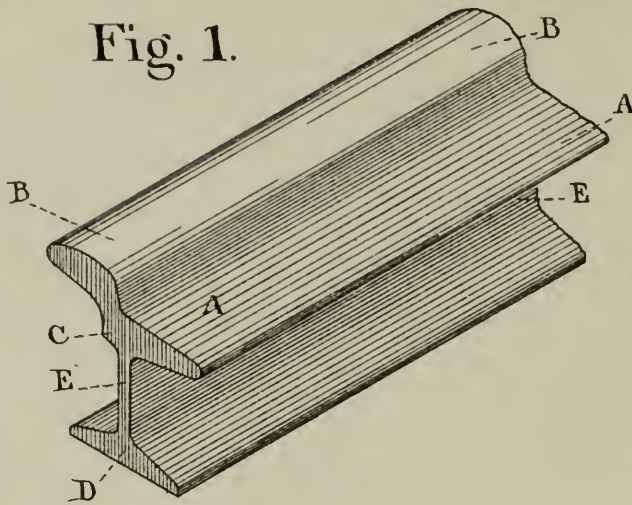

Fig. 2.

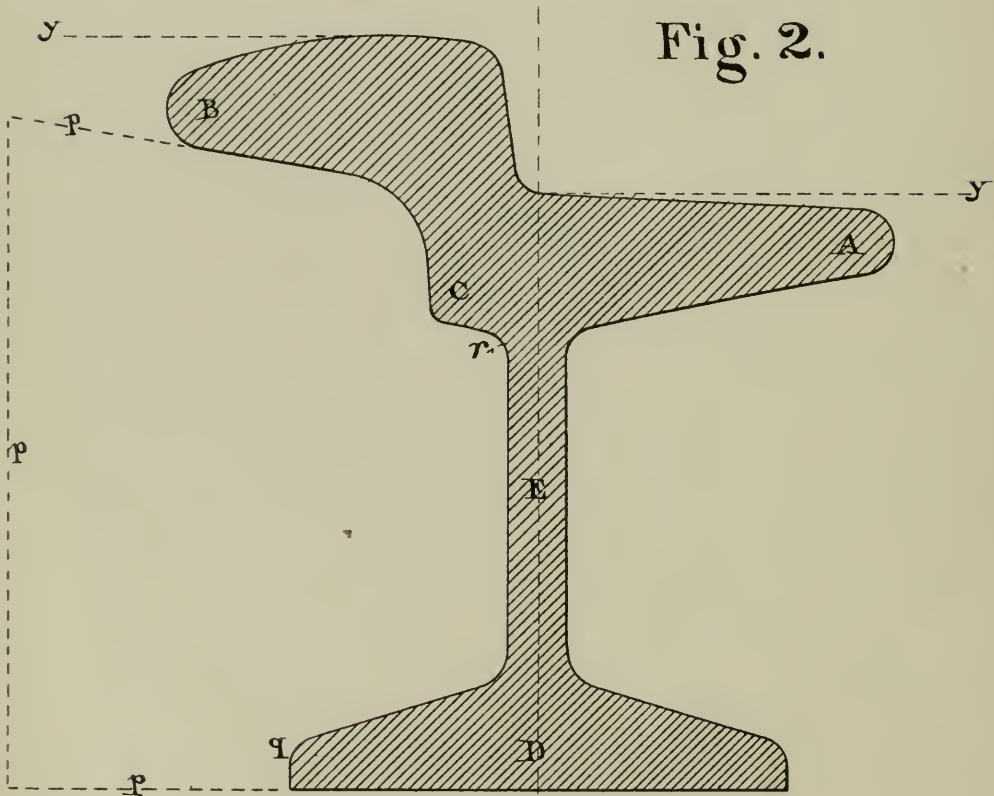
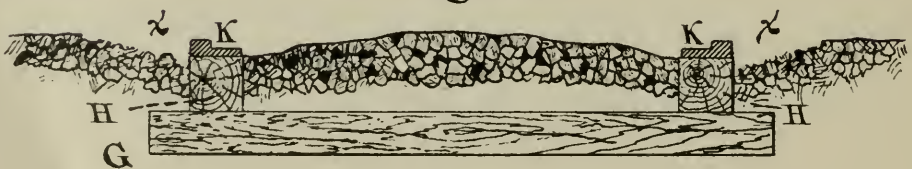

Fig. 3.



Witnesses:

Horatio C. King

Inventor .

Tom. L. Johnson



T. L. JOHNSON.

STREET RAILROAD RAIL.

No. 272,554.

Patented Feb. 20, 1883.

Fig. 4

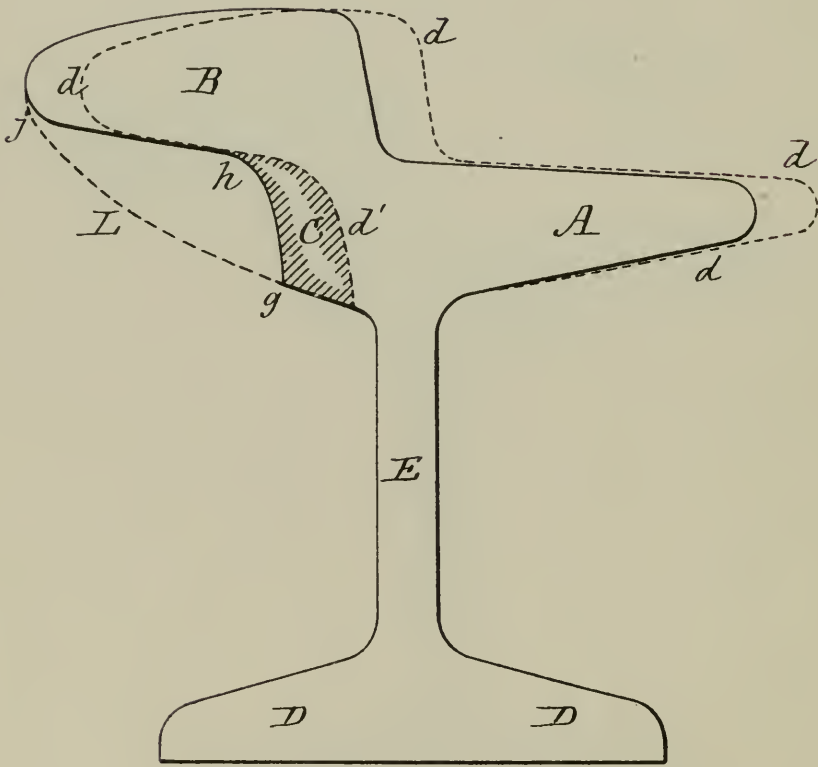

WITNESSES  
[Signature]

INVENTOR  
T. L. Johnson

69

U. S. Circuit Court, N. Dist. Cal.

THE JOHNSON CO.

*vs.*

SUTTER ST. RAILWAY CO. }

No. 10394.

*Complainant's Exhibit A.*

(Patent Sued on.)

S. C. H., *Examiner.*

UNITED STATES PATENT OFFICE.

Tom L. Johnson, of Indianapolis, Indiana.

*Street-Railroad Rail.*

Specification forming part of Letters Patent No. 272,554, dated February 20, 1883. Application filed September 11, 1882. (No model.)

To all whom it may concern:

Be it known that I, Tom L. Johnson, of the city of Indianapolis, County of Marion, and State of Indiana, have invented certain new and useful improvements in street-railroad rails, of which the following is a specification:

The object of my said invention is to improve the form of that class of railroad rail, used principally by street railroads, which combine the principal features of the tram-rail, ordinarily used for such purposes, and those of the T-rail used on steam-railroads.

I am aware that rails embodying the general features above mentioned are old, and I therefore disclaim the same, and confine myself to the form hereinafter particularly described and claimed as new.

Referring to the accompanying drawings, which are made a part hereof, and on which similar letters of reference indicate similar parts, Figure 1 is a perspective view of a portion of a rail formed in accordance with my invention, and Fig. 2 a transverse vertical section of the same. Fig. 3 shows a section of a street-railway bed and ordinary rails as commonly laid.

In said Figs. 1 and 2 the letter A indicates the flanged portion of the rail; B, the head of the rail; C, an offset under the head of the rail, abutting the web E, on the side of said web opposite to that continued out into the flange A. The web E extends from the foot D to the angles respectively formed on opposite sides by its union with the offset C and flange A, thus securing a uniform depth of web proper for the fish-plates to clamp.

In Fig. 3 the letter G indicates an ordinary cross-tie, the letters H H stringers, such as are ordinarily used upon street-railways, and K K an ordinary form of street-rail laid thereon. The letters *x x* indicate the edges of the adjacent and underlying roadway.

A peculiar and important feature of this rail is the offset C, which, while serving the purpose of a close fit for the splice-bar or fish-plate, as above mentioned, also serves another equally or more important purpose in the general conformation of and peculiar disposition of metal in the rail.

In the ordinary tram-rail or street-car rail the wear and tear of the street immediately adjoining the rails is an item of serious importance and cost. It is noticeable that after an ordinary track has been laid the street on both outer sides, in particular of the rail, becomes quickly grooved, allowing the water to collect there, by which the timber-work beneath the rails is rapidly rotted and ruined, thus, besides interrupting and annoying ordinary traffic, necessitating loss of time and heavy expense in street repairs. This wear and tear can best be illustrated by referring to Fig. 3. At the points *x x*, on the outer sides of the rails, owing to the lack of some supporting medium for the earth or gravel and ballast surrounding the rail, the street becomes quickly depressed or worn down and grooved. Such a supporting medium, however, actual practice has shown is conspicuously attained by the peculiar form of section given to the rail forming the subject of this invention on both sides, but more particularly on the outer and most important side of the rail.

The splice-bar offset C is a large factor in the proper retaining of this ballast, for it is large enough, with its square corner, in connection with the curved or arched shape of the lower part of the head and T-shaped foot, to allow the surrounding and superincumbent traffic to press the ballast—gravel and stones of the street—into and against the rail, instead of (as shown in Fig. 3) cutting away the surface of the street from the rails. By sweeping out the metal between the dotted line L and the true outline *g h j*, Fig. 4, instead of carrying the curve from the point *g* to the outer edge, *j*, a freer flow of the small stone or the looser ballast is permitted under the head, and a more capacious pocket presented for its reception than would otherwise be the case. The shape of these rails, moreover, is such that the ballast and earth are retained by them, when so pressed into them, and solidified by the ordinary street traffic. This will be apparent by referring to Fig. 2, in which the dotted outline *p p p* may represent a mass of ballast, gravel, or stone, part of the street-bed. Now, the tendency of the wheels running alongside of the track above would be to throw

the rail over on a center at about the point  $q$ , for  $q$  being taken as a center and the dotted line  $q r$  as a radius, it will be seen that the offset  $C$ , the lower curve of the same being eccentric to the assumed center at or near  $q$ , will clamp the ballast and hold the rail by reason of such clamping and also by its surface-friction. Consequently the packed earth or ballast will be gripped and retained tight-packed under the head, and between it and the offset and foot of the rail, and thus preserve the location of the rail and maintain intact the gage of the road. This latter point may be further emphasized thus: The general tendency of street-car or of other tracks is to lose their gage by spreading, rather than by closing, of their tracks. This is usually caused by the loosening of the surrounding ballast in the first place, thus taking away a main cause of resistance to the spreading tendency of the street-cars, but still more to that of the vehicles traveling on the track subsequent to such loosening. Hence the firm clamping and retaining of the outside ballast, due to the peculiar shape of this offset, together with the proportion and general shape of the under side of this rail, serves effectively the purpose of retaining the gage of the track. It is, moreover, obvious that, so far as the ballast is concerned, the reverse of this takes place—that is, the same shape and cause that clamps the rail to the ballast will serve to clamp the ballast to the rail—if we consider the rail as the stationary point of resistance, and the ballast, being now considered as a homogeneous block, as free to move over on the assumed center near  $q$ . Thus is effected the double purpose of preserving the integrity of the streets, as well as maintaining the gage of the road intact. The latter is, in fact, consequent upon the former.

Although the municipal regulations of many cities demand that a rail of not less than a given width be used, varying from four to five and a half inches, yet owing to the wear and tear of the street, due to the causes above explained, it has become imperative upon street-railroad companies to lay as wide a rail as possible; but such necessary width can only be obtained, in the rolling of a web and flange rail, by a careful location of the web with reference to the head and to the depth of flange allowed to enter each roll, for the pitch-line of the roll-train should pass through the center of the web. This demand is provided for in this rail, as will appear by reference to Fig. 2, in which the web is so located that as much of the long flange  $A$  is thrown above the pitch-line of the bottom roll as is possible, it being understood that the flange ends and the head commence at the point touched by a line bisecting the curve connecting the head and flange. By this means the greatest facility in rolling is secured compatible with the proper stabil-

ity of the rail. It will, moreover, be seen that this location of the head relatively to the vertical web secures an important economy in material, for by reference to Fig. 4 it will be seen that if the head, B, of this rail were to be thrown into the position shown by the dotted line  $d d d$  while the shoulder  $g h$  remains stationary it would necessarily increase the total mass of the metal at C to the extent of the mass contained between the outline  $g h$  and the dotted line  $d'$ .

In all ordinary rails, of whatever width, the head and flange are generally straight, or very nearly so, presenting a square corner or step to the wheels of crossing vehicles, and as a consequence the impinging wheels of such vehicles strike solidly on and mount squarely over, if crossing the rail at nearly a right angle, but if at an angle inclined to the track the wheels slide sidewise, raking, scraping and tearing the street, as shown at the points  $x x$ , Fig. 3, whereas in the rail forming the subject of this invention this wear and tear of the street is prevented by the bevel given to both its head, B, and flange, A, as is indicated by their departure from the horizontal dotted lines  $y y$ , Fig. 2; for the wheels of passing vehicles will mount and pass over these rails, particularly on the outer or head side, at any angle, with little or no tendency to slide sidewise; for it will be seen by referring to said figure that the departure of the head of said rail from the horizontal rapidly increases from the point just beyond that which would be covered by the tread of the wheels. This part of the head is, in fact, an addition to the head proper, by which addition the extreme point of the bevel is thrown below the grade of the surrounding street, thus providing for the subsequent settling of the same. This conformation of rail would be impossible if the width of head were equal or only slightly wider than the tread of the wheels. Another peculiarity of this rail is that the head, flange, web and foot are substantially of equal mass of material. In rolling iron of peculiar shape there are generally well-defined points which determine the subsequent contraction of said shape during cooling. These points may safely be defined, in a general way, as being the extremely-exposed points of the given shape. It is an object gained in the manufacture of these shapes if the relation of these exposed points one to the other is such that the respective masses, taken together with their distance from the natural neutral axis of said shape, shall the one neutralize the other in their contraction during cooling, and thus preserve a rolled bar of given shape free from distortion when cold. Thus star-iron, whose four arms are generally of equal section, remains free from distortion during cooling. In angle-iron, on the contrary, where there are three determining-points of contraction, the greater mass of metal in



that one point forming the angle causes an excess of contraction at said point, and consequently curves and distorts the bar during cooling. So in the ordinary **T** and tram rail, the greater mass of metal in the head determines in a similar way excess of contraction at that point. It is, however, consistent with the above law to have a greater mass of metal in one part than in another, provided such excess of metal be not located in one of the determining-points of contraction, but rather situated at or near what may be defined as the neutral axis of contraction.

It will be seen that were the head of the rail forming the subject of this invention constructed as is ordinarily the case such construction would throw an excess of mass of metal into one of the determining-points of contraction of said rail, by which means the rail would become, as is ordinarily the case, distorted or curved in cooling. To avoid this it will be observed that the under part of the head in said rail is cut away, by which means the mass of metal at the determining-points of contraction, taken together with the respective distances of said points from the neutral axis, is such that the rail is not distorted or curved during cooling, and at the same time there is secured a lighter and equally efficient rail.

In ordinary rails the object has been to secure the longest wear by putting a maximum amount of metal in the head—the part most subject to wear—and a minimum of metal in the other parts. The effect of such construction is that in rolling the rail, when it leaves the rolls its thin parts are cooler than its thick parts, and the thicker parts, having most material, naturally retain the heat a longer time. Now, if such rail be delivered from the rolls straight and true, but with the above-mentioned difference of temperature in its several parts, that part having the higher temperature will shrink in cooling more than the thinner and cooler parts, in consequence of which unequal shrinkage the rail, when cold, will be bent and curved, even if it had been delivered straight. In practice, to counteract this curvature in cooling, it is customary, upon the delivery of such rails from the rolls, to give them a “camber” or reverse curve, so that in cooling the rail will tend by curving in the opposite direction to straighten itself. This means, owing to the variable conditions of temperature in the different rails, can only give approximate results. Now, owing to the substantially equal mass in head, web, flange and foot of the rail, as hereinbefore described, together with their respective location from the neutral axis, the effect of temperature in the several parts is substantially uniform upon said parts. All necessity of cambering in the rolling of said rail is therefore obviated, and if the rail be delivered straight and true from the

rolls, then it will remain perfectly straight and uncurved when cold.

It will also be observed that this construction of rail permits of the under side of the head being made concave, which construction secures a larger pocket for the retention of the ballast, and a contour permitting of the more easy inflow of the adjacent ballast, as hereinbefore described, than if the under side of the head were either convex or approximately square, as is generally the case.

It is of importance to bear in mind the fact that this rail is designed for the purpose of supporting the car by the tread of the wheels and not by their flanges, as is sometimes practiced.

Having thus fully described the form, uses and advantages of my said rail, as of my invention, I claim—

1. The combined tram and **T** rail described, in which the head *b* is constructed of a proper width to prevent the car wheels from coming in contact with the paving, and inclined from near its inner to its outer side, so that the weight of the car shall be at all times upon that portion of said head which is nearly directly above the web of said rail, substantially as shown and specified.

2. A combined tram and **T** rail having the head *B*, located with reference to the center line of the web, re-enforced, as at *C*, and proportioned with reference to the flange *A* and the remaining parts of the rail, substantially as described, whereby the metal is distributed in the several parts, so as to equalize contraction therein during the process of cooling, substantially as set forth.

3. The combined tram and **T** rail described, the width of whose head is proportioned and the lower part of its head curved and offset, substantially as shown and described, so as to allow the superincumbent pressure of ordinary adjacent street traffic to force the surrounding ballast into and against, instead of from, the rail, and to solidify and retain the ballast forced against and held by said rail, thus preserving the adjacent road-bed and maintaining an accurate gage of track, substantially as set forth.

4. In the combined tram and **T** rail described, the web *E*, located relatively to the flange *A* and head *B*, as described, so that a large part of the flange *A* is thrown above the pitch-line of the bottom roll used in its manufacture, whereby, in rolling, increased facility and economy of manufacture are secured, substantially as set forth.

5. In the combined tram and **T** rail described, the web *E*, located relatively to the flange *A* and head *B*, offset at *C*, as described, whereby a maximum capacity of outside pocket is

secured with a minimum quantity of metal consistent with the proper stability of the rail, substantially as set forth.

6. A combined tram and T rail having a reverse beveled or arched head, B, the outer bevel of which is prolonged and terminates in a rapidly-descending curve, by which conformation the extreme point of said curve is thrown below the grade of the surrounding street and the settling of the street provided for, and whereby great facility is afforded for vehicles to mount over and run across said rails, and wear and tear of road-bed or ballast adjacent thereto obviated or greatly diminished, substantially as set forth.

In witness whereof I have hereunto set my hand and seal, at Indianapolis, Indiana, this 9th day of September, A. D. 1882.

TOM. L. JOHNSON. [L. s.]

In presence of

C. BRADFORD,  
E. W. BRADFORD.

(Endorsed:) Opened and re-filed Nov. 20, 1890. L. S. B. Sawyer, Clerk.

70

*Complainant's Exhibit B.*

U. S. Circuit Court, N. Dist. of Cal.

THE JOHNSON COMPANY  
vs.  
SUTTER ST. RAILWAY Co. } No. 10,374.

*Complainant's Exhibit B. (Assignment of Pat. Ex. A, to Johnson Steel Street Rail Co.)*

S. C. H., Examiner.

DEPARTMENT OF THE INTERIOR.

UNITED STATES PATENT OFFICE.

To all persons to whom these presents shall come, Greeting:

This is to certify that the annexed is a true copy from the records of this office of an instrument of writing, executed by Tom L. Johnson, 9th day of \_\_\_\_\_, 1883, and recorded in Liber R, 29, page 184. Said record has been carefully compared with the original, and is a correct transcript of the whole thereof.

In testimony whereof, I, C. E. Mitchell, Commissioner of Patents, have caused the seal of the Patent Office to be affixed this 29th day of October, in the year of our Lord one thousand eight hundred and eighty-nine, and of the Independence of the United States the one hundred and fourteenth.

[SEAL.]

C. E. MITCHELL,  
Commissioner.

Liber R, 29, P. 184.

Whereas I, Tom L. Johnson, of the city of Indianapolis, State of Indiana, have invented a certain new and useful improvement in railroad rails, for which Letters Patent for the U. S., Numbered 272,554, were issued to me on the 20th day of February, 1883; and,

Whereas, by a contract dated the 6th day of February, 1883, I did agree with J. V. Johnston, E. C. Moxham and A. I. Moxham, all of the city of Louisville, State of Kentucky, to form, under the laws of the State of Kentucky, a corporation, to be known as the Johnson Steel Street Rail Company; and,

Whereas, by said contract, I conveyed to the said J. V. Johnston, E. C. Moxham and A. I. Moxham a one-half interest in said letters patent; and,

Whereas, it was agreed between the said parties to the said contract, that the said letters patent should be transferred, assigned and conveyed to the said corporation when formed; and, whereas, the said corporation, the Johnston Steel Street Rail Company has been duly created under the laws of said State; and,

Whereas I, and the said J. V. Johnston, E. C. Moxham and A. J. Moxham, have each of us subscribed to the stock of the said corporation, and have assigned and transferred to said corporation, in part payment of the stock taken by each of us, the interest owned by each of us in the said letters patent: now therefore, in consideration of the premises, and one dollar and other valuable considerations to me paid, the receipt whereof is here acknowledged:

I, the said Tom L. Johnson do hereby sell, assign and transfer unto the said the Johnson Steel Street Rail Company the whole right, title and interest in and to the said invention or improvement in railroad rails, patent for which No. 272,554 was issued to me on the 20th day of February, 1883, as described, for the said company's own use, and for the use of the said company's legal representatives.

72 In testimony whereof I have hereunto set my hand and affixed my seal this 9 day of \_\_\_\_\_, 1883.

TOM L. JOHNSON.

In presence of  
H. L. CROSS,  
GEO. WILSON.

Recorded April 30, 1883.

EDELL, J. B. B.

(Endorsed:) Opened and refiled Nov. 20, 1890. L. S. B. Sawyer, Clerk.

73

*Complainant's Exhibit C.*

U. S. Circuit Court, N. Dist. of Cal.

THE JOHNSON CO.

vs.

SUTTER STREET RAILWAY CO. }

No. 10,394.

*Complainant's Exhibit C. (Articles of Incorporation of Johnson Steel Street Rail Co.)*S. C. H., *Examiner.*

Articles of Incorporation of the Johnson Steel Street Rail Company:

Know all men, that we, Tom L. Johnson, A. J. Moxham, J. V. Johnston, and E. C. Moxham, do hereby associate ourselves together and become incorporated under the name of the "Johnson Steel Street Rail Company" under the provisions of Chapter Fifty-six of the General Statutes, claiming the general powers granted under said chapter, to wit: To have perpetual succession; to sue and be sued by the corporate name; to have a common seal; and alter the same at pleasure; to render the shares or interests of stockholders transferable, and to prescribe the mode of making such transfer; to exempt the private property of members from liability for corporate debts; to make contracts, acquire and transfer property, possessing the same power in such respects as private individuals now enjoy; to establish by-laws, and make all rules and regulations deemed expedient for the management of said corporation or its affairs not inconsistent with the constitution or laws of this State or of the United States.

It is further specially understood and prescribed:

1. That the principal place of business of said corporation shall be Louisville, Ky.

2. That the business of said corporation shall be to develop the use and sale of the rail patented and known as the "Johnston Street Railroad Rail," to grant license to other persons to manufacture said rail under the patents relating thereto, which are now or may hereafter be owned by said corporation to manufacture and sell said rail; to procure the manufacture of said rail by other persons; and to manufacture and sell and deal in

74 all materials used in laying street railroad rails; said corporation to pursue any or all the above mentioned objects of business as it may hereafter determine.

3. That the capital stock of said corporation shall be twenty-five thousand dollars, to be divided into two hundred and fifty shares of one hundred dollars each, of which twenty-one thousand dollars shall be paid in money or property on or before the 14th day of March, 1883, the property to be transferred to said corporation in payment of the stock thereof, to be

accepted at the valuation of its directors; and the remaining four thousand dollars of said capital stock to be paid when the necessities of said corporation shall require, at such times and in such manner as the Board of Directors shall prescribe by resolution or by-laws.

The capital stock may be increased from time to time by change of these articles in accordance with Chapter Fifty-six, but no increase shall at any time be made except upon a vote favoring such increase of a majority of the stock then issued and paid up, nor unless the same be taken at par and paid for in cash, or its *bona fide* equivalent. In the event the capital stock shall be increased at any time the then stockholders shall have the right to subscribe, pay for and take the additional issue of stock in the same proposition as they may hold paid up stock at the time of such increase. In no event shall any stockholder be compelled to subscribe and pay for any stock directed to be issued as increased capital stock by the persons or person holding a majority of the stock.

If at any time when an increase of capital stock shall have been agreed on as prescribed herein, one or more of the stockholders shall decline to subscribe for any portion of the issue  
75 of increased stock, the remaining stockholder, if there be but one, shall have the right to take the whole of the increased issue, or if there be more than one, the remaining stockholders shall have the right to take the increased issue in the proportion which their holdings of paid up stock bears one to the other.

4. The time of the commencement of said corporation shall be the seventh day of March, 1883, and the time of its termination shall be at the expiration of the twenty-five years next thereafter ensuing.

5. The affairs of said corporation shall be conducted by a Board of two Directors, one of whom shall be President, and one Secretary, as may be determined upon between them; to be elected on the second Monday in March, 1883, and annually thereafter. A unanimous vote shall be necessary for the decision of all questions acted upon by said Directors. A. J. Moxham and Tom L. Johnson shall constitute the first Board of Directors, and shall serve until their successors elected.

6. Said corporation shall at no time subject itself to greater indebtedness or liability than five thousand dollars.

7. The private property of the stockholders shall not be liable to the debts of the corporation.

Witness our hands this 23rd day of February, 1883.

J. V. JOHNSON,  
EDGAR C. MOXHAM,  
A. J. MOXHAM,  
TOM L. JOHNSON.

76 STATE OF PENNSYLVANIA, }  
*County of Cambria.* }

This is to certify that on this day personally appeared before me, a Notary Public, in and for the county and State aforesaid, the above named A. J. Moxham who signed the foregoing Articles of Incorporation in my presence and acknowledged the same to be his act and deed.

In testimony whereof I have hereunto set my hand and affixed my official seal at Johnstown in the county and State aforesaid the 5th day of March, 1883.

[SEAL.]

A. MONTGOMERY,  
 Notary Public in and for Cambria County,  
 State of Pennsylvania.

STATE OF OHIO, }  
*Cuyahoga County.* }

Before me, L. A. Russell, a Notary Public, in and for said county and State, personally appeared Tom L. Johnston, this 2d day of March, A. D. 1883, and signed the foregoing Articles of Association and acknowledged the same to be his voluntary act and deed for the purposes in said articles expressed.

In testimony whereof I have hereunto set my hand and affixed my notarial seal at Cleveland, Ohio, this second day of March, A. D. 1883.

[SEAL.]

L. A. RUSSELL,  
 Notary Public in and for Cuyahoga County, Ohio.

77 I, Geo. H. Webb, Clerk of the County Court of Jefferson County, in the State of Kentucky, do certify that on this day the foregoing Articles of Incorporation were produced to me in my office and acknowledged and delivered by J. V. Johnston and Edgar C. Moxham parties thereto to be their act and deed, and that I have recorded them, this and the foregoing certificates in my said office.

Witness my hand this 7th day of March, 1883.

GEO. H. WEBB, Clk.

(The above Articles are recorded in Book No. 2, page 621.)

Amendment to the Articles of Incorporation of the Johnson Steel Street Rail Company.

We, A. J. Moxham, J. V. Johnston, E. C. Moxham and Tom L. Johnson, incorporators and only stockholders of the Johnson Steel Street Rail Company, do hereby agree that the stock of said company shall be increased from twenty-five thousand dollars to forty thousand dollars, that is to say, an increase of one hundred and fifty shares of one hundred dollars each, and one-third of said stock to be paid for in cash and issued at once, and the remainder to be paid for and issued as and when called

for by the Board of Directors of said company; and that the stock shall be subscribed for and issued as provided in Section 3 of the charter of said Johnson Steel Street Rail Company.

Witness our hands this fifth day of January, 1884.

TOM L. JOHNSON,  
A. J. MOXHAM,  
EDGAR C. MOXHAM,  
J. V. JOHNSON.

78 STATE OF OHIO, }  
County of Cuyahoga, } ss.

I, L. A. Russell, a Notary Public in and for the county and State aforesaid, do certify that on this day came the above named Tom L. Johnson, who is personally known to me, and signed the foregoing amendment to the Articles of Incorporation of the Johnson Steel Street Rail Company, in my presence, and acknowledged the same to be his free act and deed.

In testimony whereof, I hereunto set my hand and affix my official seal this fifth day of January A. D. 1884.

[SEAL.]

L. A. RUSSELL,  
Notary Public.

STATE OF PENNSYLVANIA, }  
County of Cambria, } ss.

I, A. Montgomery, a Notary Public, in and for the county and State aforesaid, do certify that on this day came the above named A. J. Moxham, who is personally known to me, and signed the foregoing amendment to the Articles of Incorporation of the Johnson Steel Street Rail Company in my presence, and acknowledged the same to be his free act and deed.

In testimony whereof, I hereunto set my hand and affix my official seal this twenty-third day of January, A. D. 1884.

[SEAL.]

A. MONTGOMERY,  
Notary Public.

STATE OF KENTUCKY, }  
County of Jefferson, } Sct.

79 I, R. S. Shreve, at Notary Public in and for the county and State aforesaid, do certify that on this day came the above named Edgar C. Moxham, who is personally known to me, and signed the foregoing amendment to the Articles of Incorporation of the Johnson Steel Street Rail Company, in my presence, and acknowledged the same to be his free act and deed.

In testimony whereof, I hereunto set my hand and affix my official seal this twenty-fifth day of January, A. D. 1884.

[SEAL.]

R. S. SHREVE,  
Notary Public, J. Co., Ky.



STATE OF KENTUCKY, }  
*Jefferson County.* } *Sct.*

I, Geo. H. Webb, Clerk of the County Court wherein and for the county and State aforesaid, do certify that on this day the foregoing amendment to the Articles of Incorporation of the Johnson Steel Street Rail Company were produced to me in my office and acknowledged and delivered by Edgar C. Moxham, a party thereto, to be his act and deed, all of which is hereby certified to the proper office for record.

Witness my hand and official seal of Jefferson County Court, this 31st day of January, 1884.

[<sup>Official</sup>  
Seal.]

GEO. H. WEBB,  
*Clk. Jeff. Co. Ct., Ky.*

I, Geo. H. Webb, Clerk of the County Court of Jackson County, in the State of Kentucky, do certify that on this day the foregoing amendment to the Articles of Incorporation of the Johnson Steel Street Rail Company were further and fully acknowledged and delivered before me, in my office, by J. V.

Johnston, a party thereto, to be his act and deed, and  
 80 that I have recorded it, this and the foregoing certificates  
 in my said office.

Witness my hand this 8th day of February, 1884.

GEO. H. WEBB, Clk.

(The above amendment to the Articles of Incorporation of the Johnson Steel Street Rail Company is recorded in Corporation Book No. 3, page 174.)

Change in the Articles of Incorporation of the Johnson Steel Street Rail Company:

Know all men by these presents, that we, A. J. Moxham, Tom L. Johnson, J. V. Johnston, T. C. Coleman, A. V. du Pont and John Townsend, being all of the stockholders of the Johnson Steel Street Rail Company, have and do hereby agree upon the following changes in the Articles of Incorporation of the said Company:

1st. The capital stock of said company is increased from forty thousand dollars (\$40,000) to two hundred and fifty thousand dollars (\$250,000), being an increase of twenty-one thousand shares of one hundred dollars each, to be issued at once as paid up capital stock. This increase of stock is based upon the accumulated net earnings of the company, the increased value of the patents and properties of the company and the patent and properties of the company acquired since the last increase of its capital stock.

2d. The highest amount of indebtedness or liability to which said corporation is at any time to subject itself is changed

from five thousand dollars (\$5,000) to fifty thousand dollars (\$50,000).

81        Witness our hands this fifth day of November, A. D.  
1885.

A. J. MOXHAM,  
JOHN TOWNSEND,  
J. V. JOHNSTON,  
TOM L. JOHNSON,  
A. V. DUPONT,  
T. C. COLEMAN.

STATE OF PENNSYLVANIA, }  
County of Cambria, } ss.

I, A. Montgomery, a Notary Public, in and for the county and State aforesaid, do certify that on this day personally appeared before me the within named John Townsend and A. J. Moxham who are personally known to me and signed the within change in the Articles of Incorporation of the Johnson Steel Street Rail Company and acknowledged the same to be their act and deed.

Witness my hand and seal this second day of December, 1885.

[SEAL.]

A. MONTGOMERY,  
Notary Public.

STATE OF IOWA, }  
County of Marshall. }

I, W. L. Dickson, a Notary Public, in and for the county and State aforesaid do certify that on this day personally appeared before me the within named J. V. Johnston, who is personally known to me and signed the within change in the Articles of Incorporation of the Johnson Steel Street Rail Company, and acknowledged the same to be his act and deed.

Witness my hand and seal this seventh day of December, 1885.

82

[SEAL.]

W. L. DICKSON,  
Notary Public.

I, Geo. A. Webb, Clerk of the County Court of Jefferson County, in the State of Kentucky, do certify that on this day the foregoing amended Articles of Incorporation were produced to me in my office, and acknowledged and delivered by A. V. duPont, T. C. Coleman and Tom L. Johnson, parties thereto, to be their act and deed, and that I have recorded them, this, and the foregoing certificates in my said office.

Witness my hand this 4th day of January, 1886.

GEO. H. WEBB, *Clk.*

(The above change in the Articles of Incorporation of the Johnson Steel Street Rail Company, is recorded in Corporation Book No. 3, page 596.)

Be it known, that a meeting of the stockholders of the Johnson Steel Street Rail Company was held at the company's office in Louisville, Kentucky, on Monday, December 17th, 1888, pursuant to call, and that all of the stockholders of said company and every share of stock issued by said company at said time were present in person or by proxy; that it was unanimously resolved that the name of said company be changed from Johnson Steel Street Rail Company to Johnson Company, and that A. J. Moxham, President, A. V. duPont and T. C. Coleman be appointed to sign and acknowledge the appropriate Amended Articles of Incorporation in behalf of all said stockholders, in order to effect said change, if none. Therefore these  
83 presents witness, that the Articles of Incorporation of the Johnson Steel Street Rail Company are hereby amended in this, that the name of said company is hereby changed from Johnson Steel Street Rail Company to, and it shall hereafter be known as Johnson Company.

In testimony whereof, witness the signatures of A. J. Moxham, President, A. V. duPont and T. C. Coleman, in behalf of themselves and all the stockholders of said company, this 17th day of December, 1888.

ARTHUR J. MOXHAM, *Pres.*  
A. V. DUPONT.  
T. C. COLEMAN.

STATE OF PENNSYLVANIA, }  
County of Cambria, } *ss.*

On this 19th day of December, 1888, personally came before me, a Notary Public in and for said County, A. J. Moxham, President of the Johnson Steel Street Rail Company, who in due form of law acknowledged the within writing, and signed it in my presence.

Witness my hand and Notarial seal at Johnstown, Pa., the day and year above stated.

[SEAL.]

A. MONTGOMERY,  
*Notary Public.*

I, Geo. H. Webb, Clerk of the County Court of Jefferson County, in the State of Kentucky, do certify that on this day the foregoing Amended Articles of Incorporation was produced to me in my office and acknowledged and delivered by  
84 T. C. Coleman and A. V. duPont, parties thereto, to be their act and deed.

Witness my hand this 22nd day of December, 1888.

GEO. H. WEBB, *Clerk.*

I, Geo. H. Webb, Clerk of the County Court of Jefferson County, in the State of Kentucky, do certify that on this day the foregoing Amended Articles of Incorporation was again produced to me in my office, and that I have recorded it, this, and the foregoing certificate in my said office.

Witness my hand, this 26 day of Decr., 1888.

GEO. H. WEBB, *Clerk.*

(The above Amended Articles of Incorporation are recorded in Corporation Book No. 5, page 125.)

STATE OF KENTUCKY, }  
           County of Jefferson, } *Sct.*

I, Geo. H. Webb, Clerk of the County Court of Jefferson County, in the State of Kentucky (said Court being a court of record having probate jurisdiction and power to appoint and qualify executors, administrators, guardians, etc., and having a common seal), do certify that the foregoing fifteen pages contain a correct and complete copy of the Articles of Incorporation of the Johnson Steel Street Rail Company and the three amendments thereto, together with the certificates of acknowledgment and record thereof, as taken from the records in my office as Clerk aforesaid.

85 Said original Articles of Incorporation of the Johnson Steel Street Rail Company are recorded in Corporation Book No. 2, page 621; the first amendment thereto in Corporation Book No. 3, page 174; the second amendment thereto in Corporation Book No. 3, page 569; and the third amendment thereto in Corporation Book No. 5, page 125.

In testimony of all which I hereunto set my hand and affix the impression of the seal of Jefferson County, Kentucky, of which I am the lawful custodian, at Louisville, this 8th day of October, 1889.

[SEAL.]

GEO. H. WEBB, *Clerk*  
*Jefferson County Court, Kentucky.*

STATE OF KENTUCKY, }  
           Jefferson County, } *Sct.*

I, W. B. Hoke, sole and presiding Judge of the County Court within and for the county and State aforesaid, do certify that Geo. H. Webb, whose genuine signature appears to the foregoing certificate, is now, and was at the time of signing the same, Clerk of said Court, duly elected and qualified, and that all of his official acts as such are entitled to full faith and credit, and that his foregoing attestation is in due form of law.

Given under my hand at the City of Louisville, Kentucky,  
this 8th day of October, 1889.

(Signed) W. B. HOKE,  
*Sole and Presiding Judge of the Jefferson Co.  
Court, Kentucky.*

86 STATE OF KENTUCKY, }  
*Jefferson County,* } *Sct.*

I, Geo. H. Webb, Clerk of the County Court, within and for the county and State aforesaid, do certify that W. B. Hoke, whose genuine signature appears to the foregoing certificate, is now, and was at the time of signing the same, Sole and Presiding Judge of said Court, duly elected, commissioned and qualified, and that all of his official acts as such are entitled to full faith and credit.

In testimony whereof, I hereunto set my hand and affix the official seal of Jefferson County, Kentucky, of which I am the custodian, at Louisville, Kentucky, this 8th day of October, 1889.

[SEAL.]

GEO. H. WEBB, *Clerk.*  
*Jefferson County Court, Kentucky.*

(Endorsed:) Opened and refiled Nov. 20, 1890. L. S. B. Sawyer, Clerk.

87 U. S. Circuit Court, N. Dist. of Cal.

THE JOHNSON Co.  
*vs.*  
 SUTTER ST. RAILROAD Co. } No. 10394.

*Complainant's Exhibit E. (Drawing Section of Respondent's Rail.)*

S. C. H., *Examiner.*

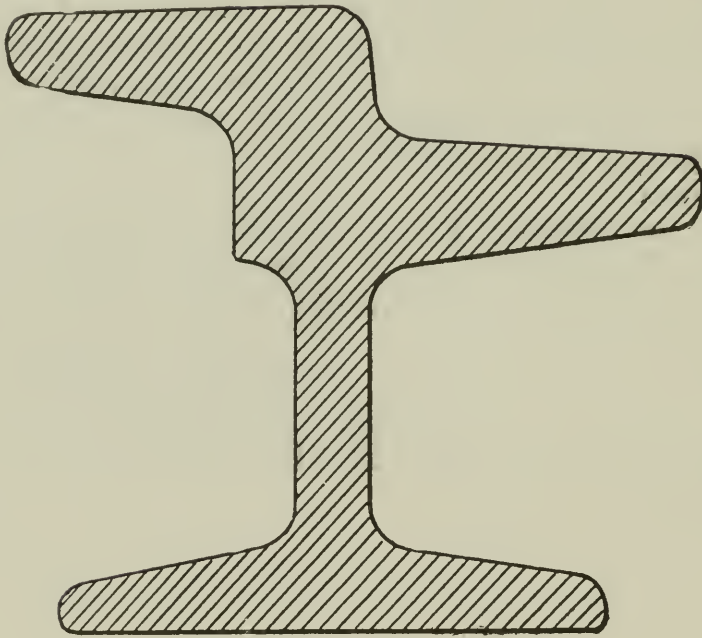

(Endorsed:) Opened and re-filed Nov. 20, 1890. L. S. B. Sawyer, Clerk.

88 *Assignment of Errors.*

United States Circuit Court of Appeals, for the Ninth Judicial Circuit.

JOHNSON COMPANY,  
*vs.*  
 SUTTER STREET RAILROAD COMPANY. } No. 10,394.

In the matter of the appeal of the Johnson Company, appellant:

Assignment of Errors: And now comes the appellant in the above cause, and says that in the record and proceedings therein there is manifest error in this, to wit:

1. The Circuit Court of the United States, for the Northern District of California, erred in the construction placed upon the fifth claim of the patent in suit.

2. The Circuit Court of the United States, for the Northern

District of California, erred in failing to find that defendant's (appellee's), rails infringed the fifth claim of the patent in suit.

3. The Circuit Court of the United States, for the Northern District of California, erred in holding that there was no invention over the prior art in the matter claimed in the fifth claim of the patent in suit.

4. The Circuit Court of the United States, for the Northern District of California, erred in dismissing the bill of complaint in said cause.

Wherefore, the said Johnson Company, appellant, prays that the decree of the Circuit Court of the United States, for the Northern District of California, be reversed, and that the Circuit Court of the United States, for the Northern District of California, be ordered to enter a decree sustaining the bill of complaint, finding that defendant's (appellee's), rails infringe the fifth claim of the patent in suit, and awarding an injunction against the defendant (appellee), in accordance with the prayer of the bill of complaint.

WM. F. BOOTH,

*Attorney for Appellant.*

(Endorsed:) Filed Dec. 28, 1891. L. S. B. Sawyer, Clerk.

90 *Petition for Order Allowing Appeal.*

In the Circuit Court of the United States. Ninth Judicial Circuit, in and for the Northern District of California.

THE JOHNSON COMPANY, Complainant,

*vs.*

SUTTER STREET RAILWAY COMPANY, Defendant.

} No. 10,394.

} In Equity.

The Johnson Company, complainant in the above entitled cause, feeling itself aggrieved by the decretal order made by said Court on the 27th day of July, 1891, and the decree made and entered on said day in pursuance of said order, whereby it is ordered, adjudged and decreed that the complainant's bill of complaint in said cause be dismissed with costs to the defendant, comes now by George Harding, George J. Harding and Wm. F. Booth, its solicitors and counsel, and petitions said Court for an order allowing said complainant to prosecute an appeal from said decree, to the Honorable, the United States Circuit Court of Appeals, for the Ninth Circuit, under and according to the laws of the United States in that behalf made and provided, and also that an order be made fixing the amount of security which complainant shall give and furnish upon such appeal, and that upon giving of such security, all further proceedings in this Court be suspended and stayed until the deter-

mination of said appeal by said United States Circuit Court of Appeals.

91 And your petitioner will ever pray.

GEORGE HARDING,  
GEORGE J. HARDING,  
WM. F. BOOTH.

Sol's and counsel for complainant.

(Endorsed:) Filed Dec. 28, 1891. L. S. B. Sawyer, Clerk.

92

*Order Allowing Appeal.*

At a stated term, to wit: the November term, A. D. 1891, of the Circuit Court of the United States of America, of the Ninth Judicial Circuit, in and for the Northern District of California, held at the court room in the City and County of San Francisco, on Monday, the 28th day of December, in the year of our Lord one thousand eight hundred and ninety-one.

Present: The Honorable Thomas P. Hawley, United States District Judge, District of Nevada.

THE JOHNSON COMPANY,

*vs.*

SUTTER STREET RAILWAY COMPANY,

} No. 10,394.

On motion of W. F. Booth, Esq., counsel for complainant herein, it is ordered that an appeal to the United States Circuit Court of Appeals for the Ninth Circuit, from the final decree heretofore filed and entered herein, be and the same hereby is allowed, and that a certified transcript of the record, testimony, exhibits, stipulations and all proceedings herein be forthwith transmitted to the said United States Circuit Court of Appeals.

It is further ordered that the bond for damages and costs on appeal be, and the same hereby is fixed at five hundred dollars.

93

*Bond on Appeal.*

United States Circuit Court of Appeals for the Ninth Circuit.

THE JOHNSON COMPANY, Appellant,

*vs.*

SUTTER STREET RAILWAY COMPANY, Appellee,

} No. 10,394.  
} In Equity.

Know all men by these presents, that we, Wm. F. Booth and J. B. Whitcomb, both of San Francisco, California, are held and firmly bound unto the above named appellee, in the sum of five hundred dollars, lawful money of the United States of America, to be paid to the said appellee, its successors and legal representatives, to which payment, well and truly to be made, we bind ourselves and each of us jointly and severally and our



and each of our heirs, executors and administrators firmly by these presents. Dated at San Francisco, California, this 29th day of December, 1891.

The condition of the above obligation is such, that whereas said appellant has taken an appeal to the United States Circuit Court of Appeals, for the Ninth Circuit, to reverse the decree rendered and entered by the Circuit Court of the United States, Ninth Judicial Circuit, in and for the Northern District of California, in the cause entitled *The Johnson Company vs. Sutter Street Railway Co.*, No. 10,394, which said decree was rendered and entered in said Circuit Court, the 27th day of July, 1891, being a day in the July term, 1891, of said Circuit Court. Now, therefore, if the above named appellant shall prosecute its appeal to effect and answer all damages and costs, if it shall fail to make good its plea, then this obligation shall be void—otherwise to remain in full force and effect.

WM. F. BOOTH,  
J. B. WHITCOMB.

Signed sealed and delivered in presence of F. D. Monckton.

UNITED STATES OF AMERICA, }  
*Northern District of California.* } ss.

Wm. F. Booth, being duly sworn, deposes and says that he is a freeholder in said district, and is worth the sum of five hundred dollars in lawful money of the United States of America, exclusive of property exempt from execution and over and above all debts and liabilities.

WM. F. BOOTH.

Subscribed and sworn to before me, at San Francisco, California, this 29th day of December, 1891.

F. D. MONCKTON,  
*Commissioner U. S. Circuit Court,*  
*Northern District of California.*

UNITED STATES OF AMERICA, }  
*Northern District of California.* } ss.

J. B. Whitcomb, being duly sworn, deposes and says that he is a freeholder in said district, and is worth the sum of five hundred dollars in lawful money of the United States of America, exclusive of property exempt from execution and over and above all debts and liabilities.

J. B. WHITCOMB.

Subscribed and sworn to before me, at San Francisco, California, this 29th day of December, 1891.

F. D. MONCKTON.

*Commissioner U. S. Circuit Court,*

*Northern District of California.*

(Endorsed:) Form of bond and sufficiency of sureties approved. Hawley, Judge. Filed Dec. 29, 1891. L. S. B. Sawyer, Clerk.

96 *Order Allowing Withdrawal of Original Exhibit.*

At a stated term, to wit: the November term, A. D. 1891, of the Circuit Court of the United States of America, of the Ninth Judicial Circuit, in and for the Northern District of California, held at the court room in the City and County of San Francisco, on Monday, the 25th day of January, in the year of our Lord, one thousand eight hundred and ninety-two.

Present: The Honorable Thomas P. Hawley, United States District Judge, District of Nevada.

THE JOHNSON COMPANY,

*vs.*

SUTTER STREET RAILWAY COMPANY.

} No. 10,394.

Upon motion of Wm. F. Booth, Esq., counsel for the complainant, it is ordered that the original exhibits "Complainant's Exhibit Section of Defendant's Rail;" "Section California Street Rail," and "Complainant's Exhibit D" (being sections of steel rails) heretofore filed herein, be allowed to be withdrawn from the files of this cause, for the purpose of being transmitted to the United States Circuit Court of Appeals, for the Ninth Circuit, as a part of the record upon appeal herein; the said original exhibits to be delivered to the solicitor for the complainant herein, and to be returned to the files of this cause in this court, upon the final determination of the appeal herein by said United States Circuit Court of Appeals

In the Circuit Court of the United States, Ninth Judicial Circuit, Northern District of California.

THE JOHNSON COMPANY,

*vs.*

SUTTER STREET RAILWAY COMPANY.

} No. 10,394.

I, L. S. B. Sawyer, Clerk of the Circuit Court of the United States of America, of the Ninth Judicial Circuit, in and for the Northern District of California, do hereby certify the foregoing ninety-six written and printed pages, numbered from 1 to

96, inclusive (excepting therefrom the original exhibits "Complainant's Exhibit Section of Defendant's Rail," "Section California Street Rail," and "Complainant's Exhibit E,"—being sections of steel rails—which said original exhibits are, by order of Court, transmitted herewith and made a part hereof), to be a full, true and correct copy of the record and of all the proceedings in the above and therein entitled suit, and that the same together constitute the transcript of the record upon appeal to the United States Circuit Court of Appeals for the Ninth Circuit.

In testimony whereof, I have hereunto set my hand and affixed the seal of said Court, this 30th day of January, 1892.

[Seal U. S. Circuit Court, Northern Dist. Cal.]

L. S. B. SAWYER,  
*Clerk U. S. Circuit Court, Northern District of California.*

UNITED STATES OF AMERICA, ss.

The President of the United States, to Sutter Street Railway Company, greeting:

You are hereby cited and admonished to be and appear at a United States Circuit Court of Appeals, for the Ninth Circuit, to be holden at the City of San Francisco, in the State of California, on the 23rd day of February, next, pursuant to an order allowing an appeal, entered in the Clerk's Office of the Circuit Court of the United States, for the Northern District of California, from a final decree duly signed, filed and entered in that certain suit wherein The Johnson Company is complainant and appellant, being in Equity No. 10,394, and you are respondent and appellee, to show cause, if any there be, why the decree rendered against the said appellant as in the said order allowing appeal mentioned, should not be corrected, and why speedy justice should not be done to the parties in that behalf.

Witness, the Honorable Thomas P. Hawley, U. S. District Judge, District of Nevada, assigned to hold and holding the United States Circuit Court, for the Northern District of California, this 25th day of January, A. D. 1892.

THOMAS P. HAWLEY,  
*U. S. Judge.*

Service of the within citation and the delivery of a copy thereof acknowledged this 25th day of January, 1892.

WHEATON, KALLOCH & KIERCE,  
*Sols. for Respondent and Appellee.*

Filed Jan. 25, 1892. L. S. B. Sawyer, Clerk U. S. Circuit Court Northern District of California. By W. B. Beazley, Deputy Clerk.



# UNITED STATES CIRCUIT COURT OF APPEALS,

FOR THE NINTH CIRCUIT.

---

October Term, 1891.

---

Johnson Company, Appellant,  
*vs.*  
Pacific Rolling Mills Company, Appellee, } No. 33.

Johnson Company, Appellant,  
*vs.*  
Sutter Street Railway Company, Appellee, } No. 34.

---

## BRIEF OF APPELLANT.

---

GEORGE HARDING,  
GEORGE J. HARDING,  
WM. F. BOOTH,  
**FILED** *Counsel for Appellant.*

APR - 9 1892



United States Circuit Court of  
Appeals,

FOR THE NINTH CIRCUIT.

---

OCTOBER TERM, 1891.

---

JOHNSON COMPANY, *Appellant*,  
*vs.*  
PACIFIC ROLLING MILLS COM-  
PANY, *Appellee*. } No. 33.

---

JOHNSON COMPANY, *Appellant*,  
*vs.*  
SUTTER STREET RAILWAY COM-  
PANY, *Appellee*. } No. 34.

---

APPEAL FROM THE U. S. CIRCUIT COURT, NORTHERN  
DISTRICT OF CALIFORNIA.

---

BRIEF OF APPELLANT.

---

STATEMENT OF THE CASE.

This is an appeal from the final decree dismissing the bills brought by the Johnson Company against the Pacific Rolling Mills and the Sutter Street Railway Company upon Letters Patent granted to Tom L. Johnson, February 20, 1883, No. 272,554, for a street railroad rail. The complainant (appellant) alleged that the respondents (appellees) infringed the fifth claim of said Letters Patent—the Pacific Rolling Mills Company, by reason of the manufacture and sale of a certain rail, and the Sutter Street Railway Company, by reason of the use of the same rail. A section of this rail is in evidence and marked “Complainant’s Exhibit D.” A drawing of this

section of rail is also in evidence and marked "Complainant's Exhibit E" (page 60, Appeal Record).

The patent in suit (shown in 42 *et seq.*, Appeal Record) says it has for its object:—

"The object of my invention is to improve the form of that class of railroad rails used principally by street railroads which combine the principal features of the tram-rail, ordinarily used for such purposes, and those of the T-rail used on steam railroads."

And the next line of the specification follows:—

"I am aware that rails embodying the general features above mentioned are old, and I therefore disclaim the same and confine myself to the form hereinafter particularly described and claimed as new."

The patent contains six claims, and an infringement was alleged against but one of these claims—the fifth—which reads as follows:—

"5. In the combined tram and T-rail described, the web E, located relatively to the flange A and head B, offset at C, as described, whereby a maximum capacity of outside pocket is secured with a minimum quantity of metal consistent with the proper stability of the rail, substantially as set forth."

The Circuit Court, in an opinion filed by Judge Hawley, held that the claim did not involve invention and that respondents (appellees) did not infringe said claim, whereupon a decree was entered dismissing the bill, and this appeal was then taken, the appellant alleging the following errors, to wit:—

*"First.—The Circuit Court of the United States, for the Northern District of California, erred in the construction placed upon the fifth claim of the patent in suit."*

It is contended that the Court erred in construing that the fifth claim of the patent in suit should be limited to a rail in which no part of the head projected directly over the line of the web of the rail (see opinion Hawley, J., page 60).



In order clearly to point out the position of the appellant upon this point, it will be necessary to again quote from the specification of the patent. The specification reads:—

“The object of my said invention is to improve the form of that class of railroad rails used principally by street railroads, which combine the principal features of the tram-rail ordinarily used for such purposes and those of the T-rail used on steam railroads.

I am aware that rails embodying the general features above mentioned are old, and I, therefore, disclaim the same and confine myself to the form hereinafter particularly described and claimed as new. \* \* \* \* In Figs. 1 and 2, the letter A indicates the flanged portion of the rail, B the head of the rail, C an offset under the head of the rail abutting the web on the side of said web opposite to that continued out into the flange, A. The web, E, extends from the foot, D, to the angles respectively formed on opposite sides by its union with the offset, C, and flange, A, thus securing a uniform depth of web proper for the fish-plates to clamp.

\* \* \* \* A peculiar and important feature of this rail is the offset, C, which, while serving the purpose of a close fit for the splice-bar or fish-plate. \* \* \* \* The splice-bar offset, C, is a large factor in the proper retaining of this ballast, for it is large enough, with its square corner, in connection with the curved or arched shape of the lower part of the head and T-shaped foot to allow the surrounding and superincumbent traffic to press the ballast-gravel and stones of the street into and against the rail. \* \* \* \*

By sweeping out the metal between the dotted line, L, and the true outline, *g, h, j*, Fig. 4, instead of carrying the curve from the point *g* to the outer edge, *j*, a freer flow of the small stone or looser ballast is permitted under the head and a more capacious pocket presented for its reception than would otherwise be the case. \* \* \* \* It will also be observed that this construction of rail permits of the under side of the head being made concave, which construction

secures a larger pocket for the retention of the ballast and a contour permitting of the more easy inflow of the adjacent ballast, as hereinafter described. \* \* \* \* ”

The claim upon which suit is brought reads as follows :—

“ In the combined tram and T-rail described, the web, E, located relatively to the flange, A, and to the head, B, offset at C, as described, whereby maximum capacity of outside pocket is secured with a minimum quantity of metal consistent with the proper stability of the rail, substantially as set forth.”

Referring back to the specification above quoted, which, as can readily be seen, is that portion of the specification which relates to the claim quoted, insomuch as it is to that portion of the specification which is describing those parts of the rail and that construction of the rail which admits of a maximum capacity of outside pocket. In the print below, Fig. A is a copy of Fig. 4 of the patent in suit, included within

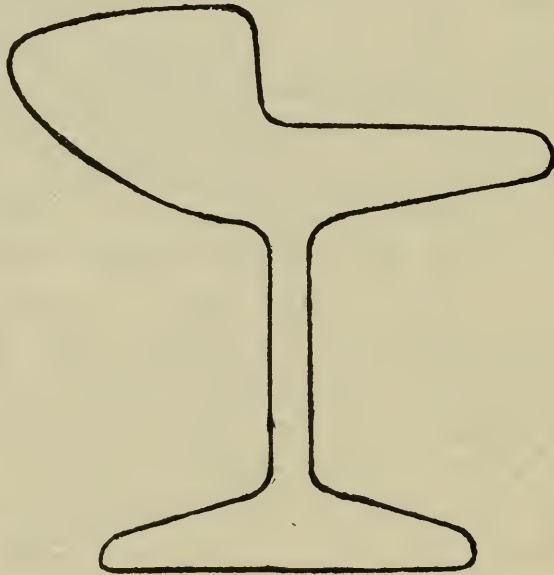

Fig. A.

the dotted line, L, and its full line continuation to the web.

Referring to that portion of the specification which treats of this figure, we quote the following :—

“ By sweeping out the metal between the dotted line L and the true line  $g h j$ , a freer flow of the small stone or the looser

ballast is permitted under the head, and a more capacious pocket presented for its reception than would otherwise be the case."

Fig. B shows Fig. A above treated as described in the

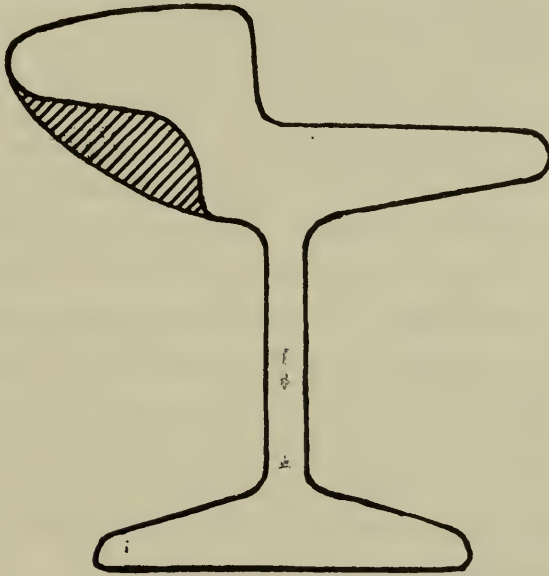

Fig. B.

patent, the section line portion indicating part to be cut away, and which would be confined within space bounded by lines *L gh j* (Fig. 4 of patent). Fig. C shows rail of patent



Fig. C.

(in this figure the sectional line portion of Fig. B has been removed).

It is evident that what is described in Fig. 4 of patent (as before stated, Fig. A of the above), is what the patentee means by his disclaimer and his statement of the object of his invention, which has been before quoted, the one following the other in the specification, so that, so far as this claim is concerned, it is contended that the invention therein claimed is for a rail which has the web, the flange and the head, the under part of the head being cut in a concave form until it strikes the fillet or projection C, when it convexes to the web, thereby providing a capacious pocket in which the ballast may lie, and also providing the fillet C, which enables even fish-plating and also performs such other functions as were alleged for it. The construction which was put upon this claim by the Court below added to the claim the limitation that the upper portion of the head of the rail, should project entirely to one side of the web.

The contention made by the appellant in reference to this position is that the 5th claim clearly shows that the purpose for which the particular invention, therein set out, was made was to enable a maximum capacity of outside pocket, to be obtained and that related, as the cuts will show, to the under side of the head of the rail; and so far as carrying out the purposes of that claim is concerned, it is immaterial whether the upper portion of the head extended to a point above the web or was wholly to one side of the web. It might have extended beyond the web so that the flange became almost infinitesimal, and yet it would not have affected the size of the outside pocket, provided the arrangements otherwise were as set out in that claim; that is, the under part head was cut away and its under side provided with the offset C, and the web, and the offset part of the head joined together as shown and described, and the web and the under side of the tram joined together as described.

The Circuit Court stated that a claim cannot be expanded beyond its clear meaning, irrespective of whatever the invention may be, which is undoubtedly sound; but where there is any ambiguity in the claim, the courts will construe the claim so as to preserve to the patentee his actual invention, as is stated in a late decision of the Supreme Court of the United States, *McLain vs. Ortmyer*, 141 U. S., 425:—

“It is true that in a case of doubt, where the claim is clearly susceptible of two constructions, that one will be adopted which will preserve to the patentee his actual invention.”

And it is also equally well settled, as a proposition of law, that one claim cannot be so construed as to make that claim cover the same thing as claimed in another claim. (*Tondeur vs. Stewart*, 28 F. R., 561; *Cohansey Glass Manufacturing Company vs. Wharton*, 28 F. R., 189.)

Applying these doctrines to the claim in point, the purpose of the claim relates entirely to “whereby a maximum capacity of outside pocket is secured,” etc.; and this purpose is satisfied by constructing the under side of the head as shown, and by having the juncture of the tram and offset C as shown; and the question of whether or not the upper portion of the head projected over the web in no way affects the carrying out of the purpose of this claim. Therefore, if this claim be vague, it certainly should be construed so as to cover that which enables it to perform its function, and no more. Again, if it be construed beyond the construction contended for, it will make said claim cover the same thing covered by other claims in the patent. Thus, if we compare this claim with the *second* claim of the patent, which reads as follows:—

“A combined tram and T-rail having the head B located with reference to the centre line of the web, reinforced as at C, and proportioned with reference to the flange A and the remaining parts of the rail, substantially as described, whereby the metal is distributed in the several parts, so as

to equalize contraction therein during the process of cooling, substantially as set forth.”

It will be seen that if the limitation is read into *claim 5*, that the head B is to be located entirely to one side of the central line of the web, and omit the purposes set out in the claim, then this added limitation to *claim 5* will make *claim 5* exactly the same as *claim 2*, as that limitation is the one point of difference between the two claims. If we refer to the specification, we can see that the offset C, while accomplishing the purpose set out above with respect to *claim 5*, permits an additional function which is made the basis of *claim 2*, to wit: it permits the mass of metal in the upper part of the head above the web to be removed so as to reduce the total mass of metal in the head to equalize the draft to insure the rails leaving the rolls straight. To equalize contraction in cooling, the head at the top must be located to one side of the web, and this is permitted by reason that the construction claimed in *claim 5* necessitates sufficient metal being at the part C. *Claim 2* simply refers to the fact that the rail has the part C, but does not make that the essence of the claim. The distribution of the metal in the upper part of the head and the arrangement of that part to one side of the web being the essence of the claim.

Again, if *claim 5* be read as construed by the lower Court, there could be no other construction given to *claim 2* than exactly that which is given to *claim 5*; and, therefore, it can undoubtedly be said that, at the least, *claim 5* is not clear, and that the construction of the claim is one which comes under the ruling in *McLain vs. Ortmyer, ante*. Such being the case it would not be proper to so construe that claim as to make it read the same as any other claim in the same patent.

*Second.*—*The Circuit Court of the United States, for the Northern District of California, erred in failing to find that defendant's (appellee's) rails infringed the fifth claim of the patent in suit.*

The defendants' rail is shown in the drawing, page 60 of the Appeal Record, and on page 27 of the Defendants' Record, is a comparison sworn to by complainant's expert, of defendants' rail and the patented rail. If the construction which the appellant contends for be correct, a glance at these two diagrams will show that the relation of the web of the rail to the under face of the tram and the under face of the head is the same, and that the under face of the head is offset, as in the patented rail. Irrespective of the difference in size of the rails, one is almost a Chinese copy of the other. If we apply the same analysis to defendants' rail that we did to the patented rail, Fig. D represents defendants' rail with

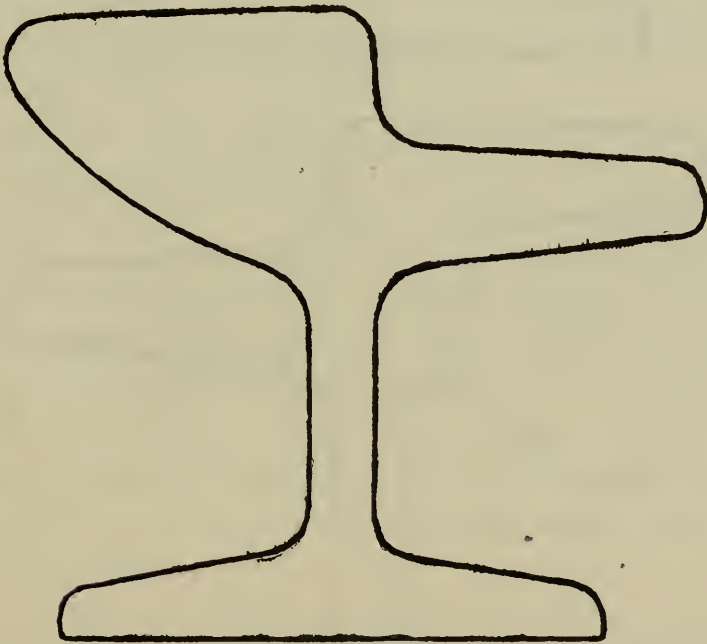

Fig. D.

the head carried as described in reference to Fig. A (*ante*, page 4), which represents Fig. 4 of the patent in suit before the patentee's change had been made. If we do to this Fig. D exactly what the patentee described with reference to Fig. 4 of the patent, that is, cut away the cross-section lines of Fig. E, we will obtain the defendants' rail, Fig. F, so

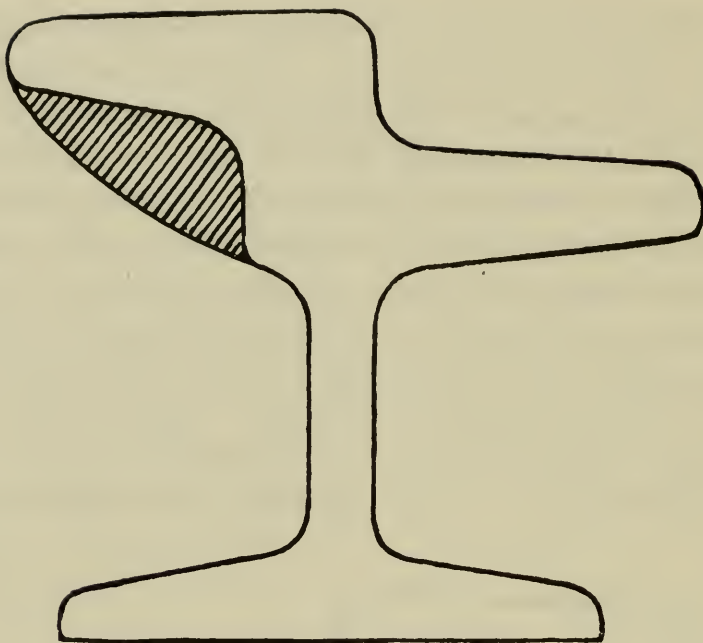

Fig. E.

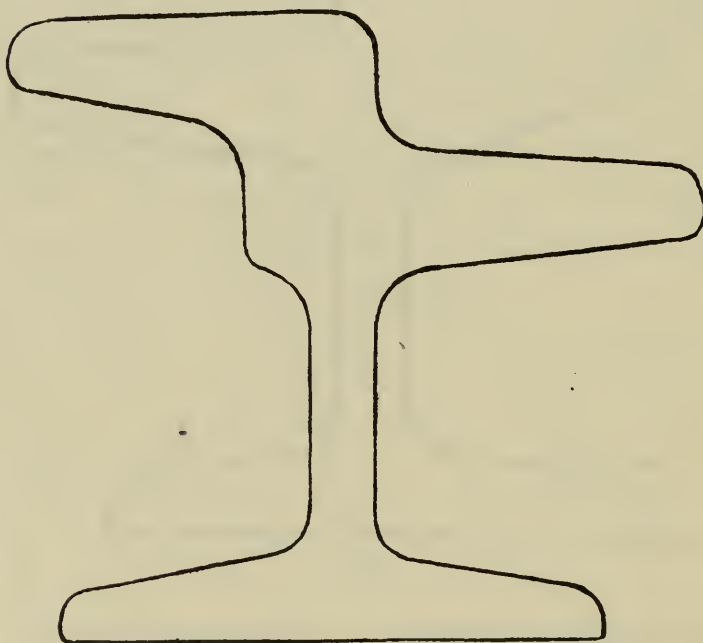

Fig. F.

that, so far as the purposes for which claim 5 was made, these defendants have performed, upon the prior rail admitted to be old in the patent in suit just exactly that which the patentee did, and has arrived at exactly the same result. It



is true that in the case of the defendants' rail, the upper portion of the head extends above the web line; but this in no way affects or modifies the pocket capacity of the rail, and the purpose of the offset as claimed will be found in the construction of the under side of the head and the juncture of the offset C and tram with the web. It was admitted by Noble, the superintendent of the Pacific Rolling Mills, that they had an offset in their rail, and that offset was put in there for the purpose of making even fish-plating (+ Q. 13 and 14, page 36, Appeal Record); and it is evident that defendants' rail obtains a greater pocket capacity than the rail admitted to be old in the patent, which is illustrated in Fig. A, page 4, *ante*; for Noble says, in answer to Q. 20, page 32: "If the curve *j-h* were continued around in a true curve it would afford a better pocket, so that in that respect we look upon offset C as a defect."

So that, from this statement, there is no doubt that doing as the patentee did—cutting off the dotted line L from the rail, admitted to be old in the patent—enabled a greater pocket capacity to be obtained. There can thus be no doubt that if the construction that appellant contends for be the correct construction of the claim, the defendants' (appellees') rail must be held to be an infringement.

*Third.*—*The Circuit Court of the United States, for the Northern District of California, erred in holding that there was no invention over the prior art in the matter claimed in the fifth claim of the patent in suit.*

The question as to what constitutes invention has formed the subject-matter of a large number of cases decided by the Supreme Court, in some of which the inventions have been sustained, and in a number of which the patents have been declared invalid for want of invention. In a late case decided by the Supreme Court (*McLain vs. Ortmyer*) it was stated:—

"What shall be construed as invention within the meaning of the patent laws has been made the subject of a great

amount of discussion in the authorities, and a large number of cases, particularly in the more recent volumes, turn solely upon the question of novelty. By some, invention is described as the contriving or constructing of that which had not before existed; and by another, giving a construction to the patent law, as 'the finding out, contriving, devising or creating something new and useful, which did not exist before, by an operation of the intellect.' To say that the act of invention is the production of something new and useful does not solve the difficulty of giving an accurate definition, since the question of what is new as distinguished from that which is a colorable variation of what is old, is usually the very question in issue. To say that it involves an operation of the intellect is a production of intuition, or of something akin to genius, as distinguished from mere mechanical skill, draws one somewhat nearer to an appreciation of the true distinction, but it does not adequately express the idea. The truth is, the word cannot be defined in such manner as to afford any substantial aid in determining whether a particular device involves an exercise of the inventive faculty or not. In a given case we may be able to say that there is present invention of a very high order. In another we can see that there is lacking that impalpable something which distinguishes invention from simple mechanical skill. Courts, adopting fixed principles as a guide, have, by a process of exclusion, determined that certain variations in old devices do or do not involve invention; but whether the variation relied upon in a particular case is anything more than ordinary mechanical skill is a question which cannot be answered by applying the test of any general definition."

Applying this to the case at point, and recollecting that this is an article of manufacture and is not for a combination of elements, the question of aggregation or combination does not enter into the question; but the question is whether the thing claimed does perform some function or use which did not exist in prior structures. The prior art in this case is

represented by the T-rail, the California street rail, and the rail admitted to be old in the patent in suit. The T-rail was a rail in which the head projected but just enough on each side of the web to allow sufficient bearing for the tread of the wheel. The rail described as old in the patent in suit is shown in Fig. A, page 4, *ante*, and the California street rail is shown below, Fig. G. This California street rail undoubt-

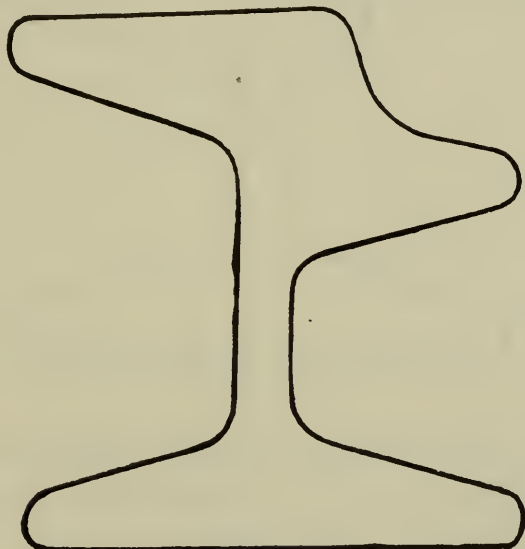

Fig. G.

edly had a large pocket capacity, but it differs from the patented rail and from defendants' rail in exactly the same particular, in lacking the offset C. Fig. H represents the

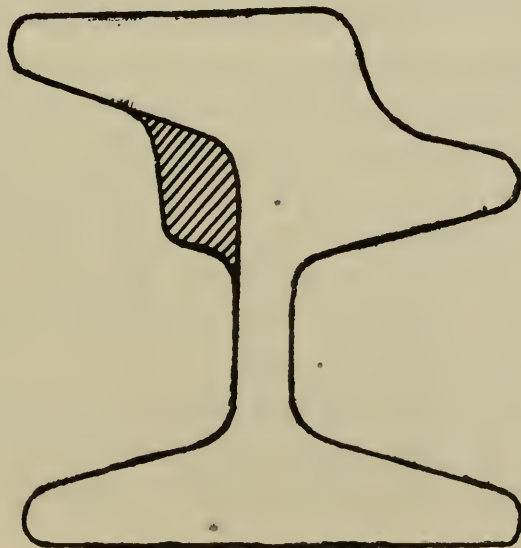

Fig. H.

California street rail with the offset C, and Fig. J represents Fig. H with section lines removed. The purpose of this

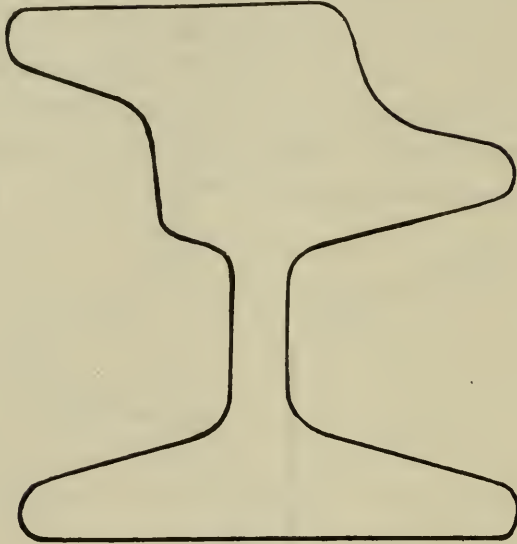

Fig. J.

offset C in this type of rail enabled a maximum capacity of pocket to be obtained, and at the same time allowed the rail to be even fish-plated. The California street rail obtained the maximum capacity of pocket with the loss of the adaptability for even fish-plating, while the rail admitted to be old in the patent in suit had adaptability for even fish-plating, and sacrificed pocket capacity by so doing. Thus, if we suppose the rail admitted to be old in the patent in suit were a rail prior to the California street rail, in order to obtain a greater pocket capacity for the ballast, the whole under side of the head was cut away, for, as the witness Noble says, in answer to Q. 21, page 33: "If he had taken (speaking of the patent) the rail made for the California street road, which was well known when his patent was taken out \* \* \* \* because the old California street rail furnishes a better pocket, the offset C being an obstruction."

But in using this California street rail, which has never been used in any other place than in California, even fish-plating was impossible, and the pocket capacity was obtained

by the sacrifice of this important feature. So the patentee in this suit devised the rail claimed in this claim of the patent in suit, which was to have the pocket capacity of the California street rail, and at the same time be so arranged, by reason of the use of the offset, as to enable even fish-plating, thus forming a rail that had greater capacities than any other rail preceding it in the art. The T-rail, to be sure, enabled even fish-plating, and its only effect in this discussion seems to be to show the advantage of even fish-plating. For this T-rail was symmetrical, so far as its head is concerned, and its head projected only sufficiently, as before stated, on each side of the web only sufficient to form a tread for the car wheel, but in no way formed, or had the capacity to form, any pocket. Therefore it can have but little bearing upon this matter. The California street rail is really a retrograde movement from the rail admitted to be old in the patent in suit; for the defendants themselves admit that even fish-plating is essential, and the very purpose for which they put their fillet under the head. The California street rail was open to them for use, and instead of adopting and using that rail, if the contention before set out in reference to the construction of the claim of the patent in suit be correct, the defendants made a Chinese copy of plaintiff's patented rail, and obtained exactly and every advantage which is obtained for said rail in the claim.

It is admittedly true that change of form, without accomplishing any new result, is not invention; but where the change of form, as in this case, accomplishes, in a single structure, that which had never been accomplished before in a single structure, invention undoubtedly exists. It must be recollected that, in these cases, a single structure, in each case, is the only thing that could be used. Thus, in the rail of the patent in suit, substantially all the pocket capacity of the California street rail is obtained, and at the same time the capacity for even fish-plating possessed by the rail admitted to be old in the patent and by the T-rail, is obtained; but in

no one of the prior rails were these capacities obtained in one single structure.

*Fourth.*—The Circuit Court erred in dismissing the bill of complaint. If the foregoing grounds urged be sound, appellant respectfully submits that the decree of the Circuit Court should be reversed and a decree entered for complainant as prayed for in the bill of complaint.

GEORGE HARDING,  
W. F. BOOTH,  
GEORGE J. HARDING,  
*Counsel for Appellant.*

# United States Circuit Court

OF APPEALS.

NINTH CIRCUIT.

JOHNSON COMPANY,

*Appellant,*

*vs.*

PACIFIC ROLLING MILLS COMPANY,

*Appellee.*

No. 33.

JOHNSON COMPANY,

*Appellant,*

*vs.*

SUTTER STREET RAILWAY COMPANY,

*Appellee.*

No. 34.

---

## Brief of Appellees.

---

M. A. WHEATON,

I. M. KALLOCH,

F. J. KIERCE,

Counsel for Appellee in each case

---

SAN FRANCISCO :

E. C. HUGHES, PRINTER, 511 SANSOME STREET.

FILED





United States Circuit Court of Appeals for the Ninth Circuit.

---

THE JOHNSON COMPANY,

*Complainant and Appellant,*

vs.

PACIFIC ROLLING MILLS COMPANY,

*Respondent and Appellee.*

---

No. 33.

---

THE JOHNSON COMPANY,

*Complainant and Appellant.*

vs.

SUTTER STREET RAILWAY COMPANY,

*Respondent and Appellee.*

---

No. 34.

*Brief of Appellee.*

These are actions in equity, brought to recover for an alleged infringement of letters patent number 272,554, bearing date February 20, 1883, granted to Tom L. Johnson for a street railroad rail, and assigned by him to the complainant.

Both of these actions were brought upon the same patent, and in both actions the same article was alleged to be an infringement. Both cases were tried together, and upon the same testimony and stipulated facts. We therefore present them both to this Court in one argument.

This patent differs from most others in that it is for a mere *form* of rail. Most contests for infringement are either upon machines which have mechanical action and the *movements and operations* of mechanical devices are brought into discussion, or they are upon patents which are for some kind of process. The present patent, however, is not for anything that involves either mechanical action or a patentable process, but *is for a mere form alone*.

In the specifications of the patent, Record page 43, it states as follows, viz :

“ The object of my said invention is to *improve the form* of that  
 “ class of railroad rails, used principally by street railroads, which  
 “ combine the principal features of the tram-rail, ordinarily used  
 “ for such purposes, and those of the T-rail used on steam rail-  
 “ roads.”

“ I am aware that rails embodying the general features above mentioned are old, and therefore disclaim the same, and *confine myself to the form hereinafter particularly described and claimed as new.*”

As a general rule, a mere change of the form of a device never was patentable. It is a different thing, however, if such change of form creates a new mode of operation which the device was unable to perform in any of its former shapes. We freely admit that whenever an inventor discovers that by changing the form of a device, he can make that device operate in a new method which was not before known, and make it perform duties in its new form which are essentially different from the kind of duties which it would perform in any of its old shapes; that such inventor is entitled to a patent for such new form of the device.

The rule is stated by the U. S. Supreme Court, in the case of *Winans vs. Denmead*, 15 Howard, at page 341, as follows :

“ Under our law, a patent cannot be granted merely for a change of form. The act of February 21, 1793, section 2, so declared in express terms, and though this declaratory law was not re-enacted in the patent act of 1836, it is a principle which necessarily makes part of every system of law, granting patents for new inventions. Merely to change the form of a machine is the work of a constructor, not of an inventor; such a change cannot be deemed an invention. Nor does the plaintiff’s patent rest upon such a change. To change the form of an existing machine, and by means of such change to introduce and employ other mechanical principles or natural powers, or, as it is termed, a new mode of operation and thus attain a new and useful result, is the subject of a patent.”

In the case cited, *Winans vs. Denmead*, the patent was for a new form of car body, especially designed for the transportation of coal. In the ordinary rectangular form of car bodies used for transporting coal, a great difficulty had been encountered on account of the tendency of the coal to keep settling and packing tightly from the constant jar of the car and pressing outwards against the sides of the car body so that it required a car body of immense strength and great weight to carry a comparatively small amount of coal. The patentee had discovered that by making the car body cone shape so that its sides flared outward, the packing of the coal was avoided and the same car with such improved body was capable of carrying twice as much coal at a load as it was capable of carrying with the former car bodies. In that case *the inventor discovered a new mode of operation* which prevented the coal from packing, by means of the conical shaped car bodies. It was an original discovery of a new principle in mechanism and not a mere change of form, the result of which could be calculated in advance by a competent mechanic.

The appellees contend in this case: first, that the appellant’s

patent is absolutely void, for the reason that it is only for one specific form of the well-known girder rails and that such specific form *did not develop any new or unknown modes of operation*. That the patented form of the rail, even if it was slightly different from any other form of rail that had ever been made, involved only such difference of operation or difference in results in its new form as mechanics well knew would belong to such new form and they could form a mathematical calculation of such different results from their knowledge of what different results belonged to different forms of rails, in advance of such particular form of rail being tried and tested.

As for instance, if it was made lighter and contained less metal than other rails, mechanics would then know it would be weaker and have less strength than other rails, for the reason that it was made lighter than the other rails. If the vertical web was made wider so that the rail was higher from its bottom to its top than other rails, mechanics would know that with the same amount of metal in it, it would have greater vertical strength than other rails, simply because it is a well-known fact in mechanics, that the greater depth such rail has, the greater will be its vertical strength. A joist twelve inches wide and two inches thick will sustain a much greater weight without breaking when it is turned upon its edge, than it will sustain if the weight is placed upon it while the joist lies flatways. So if the rail had a wider foot or wider flange at its top, it would sustain a correspondingly greater side thrust without bending, was a fact which was also well-known to mechanics. Also if that part of the head of the rail on which the car wheels bore, was directly over the web of the rail, it would have a greater direct vertical depth to sustain the weight of the cars, and would therefore sustain a greater weight of cars than it would sustain when the same part of the head was placed at one side of the vertical line of the web, as it is in the patent. If there was any object in having the fish plates which were placed upon the opposite sides of the rail of the same width, it was well-known to mechanics that such result could be effected by making the space on one side of the rail, into which the fish plate was to fit, just as wide as was the corresponding space on the opposite side of the same rail, into which the opposite fish plate would fit. This was the ordinary way of using fish plates upon all ordinary steam railroads. Mechanics also perfectly well understood that whatever space was left between the flanges of the head of the rail and the flanges which formed the foot of the rail, would form the "pockets" for street paving materials which are mentioned in the patent, and also, that such pockets could be formed and shaped to suit the wish of the constructor, whatever such form and shape might be. In other words, there is nothing about the operation of the patented form of the rail, that ordinary mechanics, who were familiar with the manu-

facture of rails, would not know by virtue of their knowledge as mechanics. *It is in fact, not pretended we believe any where in the testimony that the patentee discovered, that any new results, or any new kind of results, would flow from that particular form of the rail, except such as were well-known and could be calculated in advance by mechanics familiar with the manufacture of railroads.*

In the testimony given by the appellant's expert, he explains that such and such results *follow from the form* of the patented rail. He does not, however, undertake to testify that the patentee was the first to discover or know that such results would follow. The manner of giving his testimony by the expert shows that he knew that the results would follow from the form because it was a well-known fact that each item of result that was due to each item of form had always been well-known. He says: Record page 20.

"The patent of Johnson describes an improved form of rail, intended principally for use in streets for car service on street railway service. The rail described in the patent is designed to present many of the *advantages of the T-rail* and possessing also some *of the advantages of an ordinary tram rail.*"

In this statement, which corresponds with the patent, is explained what is above asserted, viz: that all of the advantages presented by the new rail were old and had been presented in former rails, including the well-known T-rails and tram rails. These advantages, therefore, were all old and well-known to mechanics. There was no new operation or new mode of operation developed in the form of the rail. The statement is that a part of the advantages were possessed by the old T-rail and some of the advantages were possessed by the ordinary tram rail. The most according to this statement of the expert that the patentee did, was to incorporate in one rail, some of the well-known advantages belonging to the ordinary T-rail and some of the well-known advantages of the ordinary tram rail. Transcript, pages 20 and 21.

*Even fish plating on the two sides of the rail was one of the features of the ordinary T-rail.*

From all this we think the Court cannot doubt but that the designing of the patented rail was the result of mere mechanical calculation. That there is nothing in it which—as the Supreme Court says in *Hollister vs. Benedict Manufacturing Co.*, 113 U. S., on page 72—seems "to spring from that intuitive faculty of the mind, put forth in the search for new results, or new methods, creating what had not before existed, or bringing to light what lay hidden from vision; but, on the other hand, to be the suggestion of that common experience which arose spontaneously and by a necessity of human reasoning, in the minds of those who had become acquainted with the circumstances with which they had to deal."

We think the making of this form of rail comes under the definition of what the Supreme Court said was *not* invention in the case

of "Packing Company Cases," 105, U. S. on pages 571 and 572, where quoting from prior decisions, it says: "All improvement is not invention, and entitled to protection as such. Thus, to entitle it, it ought to be the product of some exercise of the inventive faculties, and *it must involve something more than what is obvious to persons skilled in the art.*" (Citing several cases.)

The only reason why the last quotation is not strictly applicable to the appellant's rail, is because the quotation applies to an actual *improvement*, while we claim that the testimony in this case, fairly shows that the form of rail patented was a detriment and no improvement as compared with the old California street rail and rails possessing the "general feature above mentioned" which are disclaimed in the patent. (See the first fourteen lines of the specifications.) Record page 43.

We insist that neither the patent nor the testimony show anything in the formation of the patented rail, excepting only that which was a mere matter of mechanical calculation which any rail manufacturer might make, and know when he made it, and all the while that he was making it, just what the result would be, without the making of any experiments to ascertain what would be the result or mode of operation either of the rail as a whole, or of any feature presented in the entire details of its construction. There was no original conception of anything new or not already known; no search for new results or new methods but only applying old and well-known forms for obtaining old and well-known results, by old and well-known methods; no bringing to light what lay hidden from vision; but only taking certain details of construction on which the full light of the noon-day sun had shown and on which human vision had rested for more than a generation, and putting those details of construction together in an awkward manner and thereby forming a rail so inferior to others that good mechanics refuse to use it.

There was not a feature about it either of form or operation, that was not already "*obvious to persons skilled in the art*" of rail making.

We claim that the patent sued on is void, for the reason among others, that it is a patent for a mere form that developed no new mode of operation and did not involve any invention.

We pause here to cite the Court to the case of *Busell Trimmer Co. vs. Stevens*, 137 U. S. 423. The decision stated is so exactly in point that we will here present it. In its opinion on page 433, the Supreme Court says:

"Effort was made to show by other witnesses that the features in the Orcutt patent, specified in the statement of counsel above quoted, are all patentable novelties, especially *the combination of them into one device*. We repeat, that in view of the previous state of the art, we think otherwise. The evidence, taken as a whole, shows that *all of those claimed elements are to be found in various*

“ prior patents—some in one patent, and some in another, but all performing like functions in well-known inventions having the same object as the Orcutt patent, and that there is no substantial difference between the Brown metal-cutter and Orcutt’s cutter, except in the configuration of their molded surfaces. That difference, to our minds, is not a patentable difference, even though the one cutter was used in the metal art, and the other in the leather art. A combination of old elements, such as are found in the patented device in suit, does not constitute a patentable invention. (*Florsheim v. Schilling*, ante, 64, decided at this term of the Court, and cases there cited,)” and further, on page 435:

“But the patent before use is no such case. The most that can be said of it is that it shows, on the part of Orcutt, great industry in acquiring a thorough knowledge of what others had done in the attempt to trim shoe-soles in a rapid and improved mode, by the various devices perfected by patents for that purpose, good judgment in selecting and combining the best of them, with no little mechanical skill in their application; *but it presents no discoverable trace of the exercise of original thought.*”

What we ask is there in the patented rail according to the appellant’s own showing other than taking well-known elements or forms of other well-known rails in which the same functions were performed by the same forms as in the patented rail, some parts of the form being so taken from one rail and some from another, but all performing like functions in these old well-known rails, and aggregating those older forms into the patented rail? Does this not clearly come within the quotation just made from the recent decision that:

“ A combination of old elements such as are found in the patented device in suit, does not constitute a patentable invention.”

The following quotation from the closing part of the same opinion is also, we think, strongly in point.

“ *It may be admitted that Orcutt’s later patent performed the work it was designed to accomplish in a better and more workmanlike manner than any of the preceding cutters patented, because, as already stated, there were constant improvements in the art to which it related. So far as this record shows, it was the last of a series of patents designed to accomplish the same object. As such, it necessarily retained all the beneficial features of those earlier patents, and, to a certain extent, improved upon them. Such improvement, however, was an improvement in degree only, and was therefore not patentable. (Burt vs. Ivory, 133 U. S., 349, and cases there cited.)*”

The decision was against a patent which came much nearer showing a patentable invention than does the appellant’s patent. In the case cited the patent described a very ingenious machine made up of movable parts. The machine was confessedly a better machine

than any which preceded it. It combined for the first time in one machine, the *particular form* of elements of which it was composed. Although other combinations of the *same kind* of elements with *less perfect forms* had been made, and the same perfected form of elements which the patentee embodied in his one machine, had been severally used in different machines of the same general character and used for the same purpose, yet the patentee for the first time brought together in one machine, the best form of the elements which could be found in all the various machines of that kind; and in doing so, as the Supreme Court admits, he displayed "great industry in acquiring a thorough knowledge of what others had done" and also "good judgment in selecting and combining the best" of the various devices which others had used in the same class of machines, and "no little mechanical skill" in doing so, but it was not invention.

In the appellant's case, all that the patentee did was to pick out certain *existing* details of forms from well-known rails and combine for the first time those details of forms in one rail. We deny that in doing so he displayed even good judgment since his rail is not as good as other rails. The evidence of Patrick Noble shows that it is an inferior rail, and his testimony is not contradicted. (Transcript, pages 31-32.) It is a rail made up of forms which the appellee does not and would not use. Nor does the testimony show that the appellant who owns the patent uses it. It is a common practice in the trial of patent cases for the complainant to prove, when such is the fact, that the patented device has gone into use since the patentee made the invention and has to that extent supplanted other devices of the same general class which the public were already using for the same purposes that the patented invention was applicable to. Such facts, when proved, are very strong evidence of both the novelty and utility of the patented invention. If such facts are not shown, it leaves the presumption very strong that the patented device is not as good as those that preceded it.

It is a well recognized rule of evidence in patent cases, that extensive use is evidence of utility and great utility and extended use *after* the invention is made by the patentee is evidence of novelty and invention.

See *Adams vs. Edwards*, 1 Fisher's Patent Cases, page 6.

*Parker vs. Hulme*, *ibid* 53.

*Many vs. Sizer*, *ibid* 24, 27 and 28.

*Magowan vs. New York Belting Co.*, 141 U. S., page 343, and references there cited.

The reverse of this rule follows as a matter of course, viz: That non-use of an invention after the patent is granted, shows want of utility and lack of novelty.

Not only does it not appear that the patentee of this form of rail exercised good judgment in the selection of forms from other rails,

but it also appears from the nature of the patent that it required no mechanical ingenuity whatever to make up the combination of forms shown. A mere form can be made on paper with a full knowledge that the device can be made in that form. It is a very different thing, however, when working devices are combined as it often requires the highest degree of mechanical skill to so put them together that they will be operative in making their intended movements. It is a well-known and constantly recognized fact among mechanics that the several parts of an apparently operative machine may be drawn out on paper and as so drawn, good mechanics will see no reason why the parts, when constructed as drawn, will not be operative; and yet, when the parts are constructed they will be found to be totally inoperative, for the reason that nature will raise and present natural obstacles which the mechanic did not foresee. Thousands of perpetual motion machines have been drawn by skilled mechanics, on paper, which looked as though they could not fail to go, and thousands upon thousands of dollars have been expended by such skilled mechanics in efforts to make them go, and in the firm belief that they finally would go; but none of them ever went yet. The very best constructors and mechanics approach the trials of their new machines with apprehension for fear that they may fail to work satisfactorily. In probably nine cases out of ten the first trial of a finished machine of a new kind, will require many alterations before it will do its intended work, and not unfrequently such new machines, even when designed by the most experienced and skilled constructors and mechanics, turn out to be worthless, and have to be totally abandoned for the reason that they utterly fail to perform the work for which they were intended. Long as the "Keely Motor" has been a practical failure, hopes are still entertained that it may yet succeed and work a revolution in the motor power of the world. The exact weight, tonnage, and water displacement of the U. S. war vessel "Charleston" could be and was accurately calculated in advance of her construction, and pictures of what she would look like when built, were easily made with accurate certainty. But when her mechanical performance was to be foretold, it could only be approximately estimated. Yet every part of her machinery and boilers and furnaces were but duplicates of what had been made and tested and tried a thousand times in other places, and in other machinery. With what feelings of apprehension and hope and fear were her trial trips watched in order to learn at what speed her machinery would be capable of driving her. We repeat that the boot trimming machine, being made up of working devices, whose several actions must be made to harmonize with each other, required a vast amount more of ingenuity and skill for its construction, than was required in merely forming the appellant's rail. As between the trimming machine which was declared not to contain any patentable invention by the Supreme



Court in the case cited and the appellant's rail, the former came very much nearer the line of invention than does the latter.

In the case of *Smith vs. Nichols*, 21 Wallace, on page 119, the Supreme Court says :

“ But a mere carrying forward, or new or more extended application of the original thought, a change only in form, proportions or degree, the substitution of equivalents, doing substantially the same thing in the same way, by substantially the same means *with better results*, is not such invention as will sustain a patent. These rules apply alike, whether what preceded was covered by a patent or rested only in public knowledge and use. In neither case can there be an invasion of such domain and an appropriation of anything found there. In one case, everything belongs to the prior patentee, in the other, to the public at large.”

The foregoing is but a redeclaration of previous authorities to the effect that a change only *in form or degree* of things already in existence, which does substantially the same thing in the same way and with substantially the same means, *although with better results*, is not such an improvement as will sustain a patent. This quotation from *Smith vs. Nichols*, was in substance repeated by the Supreme Court in *Dunbar vs. Myers*, 94 U. S. on page 199. It was also requoted by the Supreme Court in *Burt vs. Evory* 133, U. S., on pages 358 and 359. This case of *Smith vs. Nichols*, 21 Wall., 115, has been repeatedly by the U. S. Supreme Court, and was cited as authority in *Reckendorfer vs. Faber*, 92 U. S., 354.

*Roberts vs. Ryer*, 91 U. S., 159.

*Phillips vs. Detroit*, 111 U. S. 607.

*Morris vs. McMillin*, 112 U. S. 249.

*Stephenson vs. Brooklyn R. R. Co.*, 114, U. S. 154.

*Dunbar vs. Meyers*, 94 U. S., 199.

*Burt vs. Evory*, 133 U. S., 358.

*International Tooth Crown Co., vs. Gaylord*, 140 U. S., 62.

*Butler vs. Steckel*, 137 U. S., 29.

*Penn. R. R. Co. vs. Locomotive Truck Co.*, 110 U. S., 494.

In the case of *Hill vs. Wooster*, 132 U. S., on page 700, the Court says :

“ This Court, however, has repeatedly held that, under the Constitution and the Acts of Congress, a person to be entitled to a patent, must have invented or discovered some new and useful art, machine, manufacture or composition of matter, or some new and useful improvement thereof, and that *it is not enough that a thing shall be new, in the sense that in the shape or form in which it is produced, it shall not have been before known*, and that it shall be useful, but it must, under the Constitution and the statute, amount to an invention or discovery,” citing a long list of authorities.

The foregoing quotation was repeated by the Supreme Court with approval in *Burt vs. Evory*, 133 U. S., on page 359. As a result

following the rule contained in the quotation, the Court held that the patent sued upon in *Burt vs. Ivory*, which was for an improved shoe, was void, for the reason that what was covered by it was “merely a carrying forward of the original idea of the earlier patents on the same subject, *simply a change in form and arrangement of the constituent parts* of the shoe, or an improvement *in degree only.*”

Two of the late decisions rendered by the Supreme Court, *Butler vs. Steckel*, 137 U. S., 21, and *Shenfield vs. The Nashawannuck Manufacturing Co.*, 137 U. S. 56, were brought on patents that were substantially for forms. The first patent included the form of a die for cutting dough so as to make a form for “bretzels” that would give them the appearance of being made by hand. The second patent was for making suspender ends of flat cord bent into a loop, laid flatwise and fastened in a particular way. In both cases the Supreme Court decided that the patents were invalid for the reason that they did not cover any patentable invention.

It seems to us that under the foregoing decisions and the tests therein applied for determining when a form may be patentable, that the appellant’s patent is invalid and the decrees should be affirmed upon this ground.

The appellant’s patent is for a form only. Such form, even if it was new with the patentee, consists only in changing very slightly the old form of rails. As to such new form, the patentee in his specifications of the patent says: “I am aware that rails *embodying the general features above mentioned are old, and I therefore disclaim the same, and confine myself to the form hereinafter particularly described and claimed as new.*” Thus, by the very terms of the patent, the change of form which was made by the patentee could have been an improvement in degree only. The “general features” were old. It was a change *in form only*. Taking the patent for all that it itself says, and also for all that is said for it in the testimony, the patentee did nothing except to take rails which possessed certain general features or details of form and change those details of form to a greater or less degree and nothing else. The changes were not only confined to changes of form, but they were confined to changing the old forms in matters of degree only. The old rails had each a foot and web and a flange opposite to the head and those feet and web and heads and flanges furnished pockets for the reception and retention of the paving material. The patentee claims to have changed the form of the foot, web, head and flange so as to make a larger pocket for the paving material than the old rails furnished. He also claims to have changed the form so as to put the shoulder on one side of the web, against which the upper side of the fish plate bears in a lower position than it was placed at in the old California Street rail. What after all is said that has been said or can be said, are these changes except changes in degree only. In the

old California Street rails there was a foot for each rail, and there was also a web, and there was a head on one side and a flange on the other side, and there was a shoulder on each side against which the upper edges of the fish plates bore. The parts were all there and the rails were good practicable rails. They were *good enough to be used*, a fact which does not appear to apply to the patented rails. Was the putting of the shoulder against which the edge of the fish plate bore in a lower position than it was before, anything except a change in the degree of its height? Of course not. Was the idea of making the fish plate on one side of the web of the same width that it was on the other side, anything but a change in degree as to the width of the fish plate? Of course not. There was no result following this making of the fish plates of equal width except the mere fact that they *were* of such equal width. No new mode of operation followed making them of equal width nor did any other material advantage follow. The fish plates were equally useful, and equally effective, and operated in exactly the same manner when they were of unequal widths as when they were of equal widths. They were of equal widths on all ordinary steam railroads. They were of unequal widths on the old California Street cable road. They performed exactly the same service and were just as effective in one case as in the other.

Much has been said in regard to the offset C, of the patent. The expert, Henry L. Brevoort, points out that the old California Street rail did not have this offset. The old California Street rail is in evidence and marked "Section California Street Rail." It was put in evidence while taking the deposition of said expert in New York.

The reason why the said offset was not applied to the California Street rail, as well as why it would not now be applied to that rail is very obvious when the California Street rail and the appellee's rail are placed side by side and their relative heights compared. The web of the California Street rail was a narrow one while the web of the appellee's rail is considerably wider. If the California Street rail had the offset put on it, it would have made both the fish plates very narrow. It was better to have one of the fish plates wider in order to have more strength of fish plates at each joint. In the appellee's rail the web is much wider and if the shoulder which is called the offset was not there it would require more width of fish plate to fill the space than was necessary to obtain the amount of strength required of the fish plates to do their work.

By standing the section of the appellee's rail in evidence beside the section of the California Street rail in evidence, it will be seen that the widths of the wide and narrow fish plates that were used on the two opposite sides of the California Street rail when added together amount to just about the same as the two equal widths of the appellee's fish plates amount to when they are added together. This shows that the mechanics who designed the respective rails

well knew the size and strength of the fish plates that would be required at each joint of the rails, and they also well knew how to shape the rails to obtain that size and strength notwithstanding that they used webs of different widths in the two sets of rails. *Ordinary rails had even fish plates on their opposite sides. The appellee followed this old ordinary style and placed the shoulders against which the edges of the fish plates were to bear in the same positions in which the corresponding shoulders had always been placed on ordinary steam railroads. The change from this usual location of such shoulders was made in the old California Street rails. The appellee in this respect only went back to the old method in locating these shoulders upon their rails.* (Evidence of Brevoort, Record, page 24.) By going back to this old method the change made in the form and location of the head necessarily left the so-called offset in its place. The form of head used by the appellee is confessedly not the patented form of head. If it was, the appellant would have claimed that other claims of the patent besides claim five were infringed.

As it was the common practice to make the distance between the foot and shoulders against which the edges of the fish plates bore of equal distances apart on both sides of the rails on all ordinary steam railroads, it, of course, required only the knowledge of ordinary rail makers to do the same thing for street rails and doing it could not involve any new invention. This patent therefore, well illustrates why the rule may be a just one which holds that a mere change of form involves only mechanical skill and does not include any patentable invention, as well also as the rule that such changes as make an improvement in degree only (which the change in this case did not even do) is not patentable.

It is claimed in this case that the appellee's rails infringe the fifth claim only of the patent. It is admitted that the appellee's rails do not infringe any of the remaining five claims of the patent. The specific changes made by the patentee, which are asserted to be the subjects of such other five claims, we will not stop to notice, as they are practically out of the case. The admission that the appellee does not infringe but one out of the six claims of the patent goes to some length in corroborating the testimony of Mr. Noble, the superintendent of the Rolling Mills, to the effect that the patented rail is an inferior rail and one that the appellee does not use and would not use.

### **Aggregation Instead of Combination.**

As there are a large number of cases decided by the Supreme Court in which the patents were held to be void upon the ground that they did not cover any patentable invention, and as many of those decisions held that what were called "*combinations*" in the patents were in fact but "*aggregations*" and for this reason they did not cover any patentable inventions, we will next present this sub-

ject of "aggregation" and then refer the Court to many in the long list of the decisions referred to, and which cover the general subject of want of invention.

Of the first twenty-nine decisions rendered by the Supreme Court after the beginning of the October term in October, 1889, in patent cases, more than one-half of the patents on which those suits were brought were decided to be invalid for the reason that they did not cover any patentable inventions.

We have not made an estimate as to the comparative number of patents that have since been declared void by the Supreme Court for the reason that they did not cover any patentable invention, but are well enough informed upon the subject to say that the Supreme Court has not changed its course of rulings in the matter. It has been deciding patents to be invalid upon the ground that they did not cover any patentable invention, right up to date. The last patent case that the Supreme Court decided, of which we have any knowledge, was decided on the fourteenth day of March, 1892, only about one month ago. The case was

*Ansonia Brass and Copper Co. vs. Electrical Supply Co.*, and is reported in Vol. 58 O. G., page 1692. In that case the Supreme Court held that the patent was void for want of patentable invention, and cited as references to support the decision several cases which we cite elsewhere in this brief.

See also,

*Consolidated Roller Mill Co. vs. Walker*, 138 U. S., 124.

*Union Edge Setter Co. vs. Keith*, 139 U. S., 530.

*McClain vs. Ortmyer*, 141 U. S., 419.

*Adams vs. Bellaire Stamping Co.*, 141 U. S., 539.

*Patent Clothing Co. vs. Glover*, 141 U. S., 560.

*Cluett vs. Claflin*, 140 U. S., 180.

From all this it is seen that there is a wide difference between the decisions of the Patent Office and the decisions of the Courts as to what constitutes patentable *inventions* as distinguished from the exercise of mere *mechanical skill* in the building of new structures.

In addition to our claim that the appellant's patent is void for the reason that it covers only a mere form of rail, we further attack its validity upon the ground that its combination of forms comprises only that kind of combination which is known in law as an "aggregation" instead of covering that kind of combinations which are recognized as patentable "combinations." There is a long list of decisions by the U. S. Supreme Court, as well as by other Courts, which holds that such combinations as constitute aggregations only, are not patentable. Aggregations which are not patentable, may be made by joining together mechanical devices in a machine in which the operation of each device is added to the operations of the other devices, so that the sum total constitutes only an addition of several

other end. The whole power of the mainspring is brought to bear upon every other one of the devices and the functions of the other devices are brought to bear upon the action of the power of the mainspring so as to restrain and control and regulate its action, as its power is being transmitted through them to the hands. The accurate movement of the hands is the ultimate result that flows from the mutual joint action of all the parts. Such action is not obtained by a mere adding together of the action which each device contributes, but it is obtained by blending the several action of each device with the several action of every other one of the devices. Not only does every one of the devices work at the same time that every other device is working, and not only do they all work together, but the action of every one of the devices *bears upon every other device and the action of every other device, every moment of the time that the machine is in operation;* and if the action of any one of the devices ceases, the action of *every* other device, either ceases altogether or is disarranged, and there is no longer the *same kind* of action performed by the remaining devices as a whole, or by any one of the devices individually, as was performed by those remaining devices, as a whole, or by each of them individually, before the one device ceased its operation. If the mainspring was left unrestrained to run the hands alone, they would run their courses in a very few seconds, instead of being twenty-four hours in making their revolutions, and no time would be kept. It requires the balance wheel, escapement and hairspring acting together to regulate the proper movement as to speed. In order to connect the power of the mainspring with the hands so as to make them move just at the rate of motion required, other wheels are introduced into the mechanism to which the hands are attached. To tell the correct time, one of the hands must be made to run twelve times as fast as the other hand moves. This requirement calls for the introduction of other wheels. When the whole is completed, the ultimate result is the steady accurate movement of the hands. It is not the movement of the hands only, but it is their accurate regulated movement relatively to each other and to the passing time. Take out any one of the intermediate wheels, and although the whole power of the mainspring would remain, yet the ultimate result would be lost. As much power would remain in the machine as before and probably much more action, depending upon what wheel was removed. But the action would not be the same, nor of the same kind, for the reason that the influence of the omitted wheel would not be applied to it, and its quality would be changed, and the watch would not keep nor tell the time of day. One of the wheels being left out, the individual working of the other wheels would be changed. In the case of an aggregation, if one of the wheels is left out, each one of the remaining wheels will do its individual work the same as when all the wheels are in place, although the continuity might be so

broken, that the apparatus as a whole would not do its intended work, just as a single impassable place in a long bridge will prevent travel over the bridge, notwithstanding that all the remainder of the bridge is in good operative condition.

The case of *Burt vs. Evory*, 133 U. S. 349, was not decided until February 3rd, 1890. It has since been cited by the Supreme Court with approval, and as an authority, in the cases of *Busell Trimmer Co. vs. Stevens*, 137 U. S., on page 433; also in *French vs. Carter*, 137 U. S., on page 245; and also in *County of Fond Du Lac vs. May*, *ibid* page 407. It may, therefore, now be considered as a leading case in the present line of decisions. Regarding it as a leading case, it is not only very important, but it is interesting from the fact that the shoe which the patent covered is fully explained in the report and is easily understood. The shoes were made with a double extension gore upon each side of the shoe which readily extended to admit the foot, and which could then be folded forward over the instep and be secured by a buckle or knot or lacing. The specifications of the patent, in stating the general character of the invention and its advantages said, beginning on page 351: "Our said invention consists in a novel mode of constructing shoes and gaiters, whereby the ordinary elastic goring at the sides and the tedious lacing up at the front are both dispensed with, while at the same time the tops will expand to receive the foot, and fit neatly and closely around the ankle when the shoe is on, being also water tight to the extreme top of the shoe."

Special advantages were claimed in the specifications for the shoe in the following particulars, viz: "First, it requires less stock in its construction, and is therefore cheaper than those in which the gore is inserted in the heel; second, it is neater in appearance, and, being adjustable to the ankle, it may be fitted even where there is a variation in the size of the shoe, thus rendering it more available in the construction of shoes for sale at wholesale; third, it avoids the wrinkle in the heel in Babbit's construction of shoes, which, being exposed to the friction of the leg of the pantaloons, soon wears into a hole; fourth, by giving expansion forward to the vamp in front of the ankle, it admits of the more easy introduction of the foot, and allows a neater fit than is attainable when the gore is in the heel."

The description and claim of the patent are on pages 351, 352 and 353 of the report.

The Supreme Court, in rendering its decision, referred to those portions of the evidence which show the kind of shoes most like the patent which had been constructed when the patented improvement was made. *None of these references constitute an anticipation of the patent.* As the Supreme Court says on page 357: "Such was the state of the art when Evory and Heston made their application for the patent in suit."

This Court well understands the distinction between proving “*the state of the art*” to which the patented improvement belongs and proving an “*anticipation*” of such patented invention. An anticipation shows that the patented improvement was not new with the patentee, but that the *same thing* which is covered by the patent had been done before and was older than the patentee’s invention. Proof of an *anticipation* of the thing patented cannot be introduced unless due written notice, either by pleading the same in equity suits, or by setting the same up in the answer, or otherwise giving written notice thereof in suits at law, has been given by the defendant to the plaintiff.

On the other hand, proof of the “*state of the art*” is given without pleading the same or giving any notice thereof. The state of the art is shown when there has been no actual anticipation of the *identical thing patented*. It is given for the purpose of showing the extent of the invention which is covered by the patent. The extent of the patentee’s invention which is covered by the patent, is proved for the purpose of showing to what extent the patentee has discovered and introduced a *new principle or mode of operation*.

If what the defendant in a patent suit makes is precisely the *same thing* thing that is covered by the patent, the infringement is manifest and there is no need of proving the state of the art for the purpose of showing the infringement. But in most cases, what the defendant makes is not the same thing as that described in the patent. If, however, the patentee has made an original invention, in which he has constructed, say for instance, a *machine* that is different from any other machine that was ever made, as, for example, Howes’ sewing machine, or the first reaping machine, or the first telephone, the invention must not only have been of the machine that is constructed, but it must also have included the *first and original discovery of the principle or mode of operation of that machine*. Unless such patentee of a first original machine had *first* conceived the idea that a machine could be made involving such mode of operation, he could never have made the machine. In such case an infringement occurs whenever a second party constructs a machine that operates upon the same general principle and mode of operation, producing the same kind of results as does the patented machine.

Unless such inventor had first conceived the idea of the general principles and mode of operation of the machine, he could never have commenced its construction. Doubtless many machines will be made in the future of great utility and value, that have never yet been thought of. Such machines would have been made long before this time, if any one had ever thought of them. The person who first thinks of one of them, who *first* conceives of their *general nature and construction, and mode of operation*, will be an original discover of an original principle. The *soul* of the machine will be of



his begetting, as well as the construction of it. To illustrate the importance of such *first* conception, let us take the case of the sewing machine. The world had been moving for six thousand years and was filled with mechanics and machinery, when Howe first thought of the possibility of a sewing machine. We have no reason to suppose that any other man had ever conceived the idea of such a possibility before. Howe, in this original conception, stood *solitary and alone*. Of all the numberless millions that had lived and died before his time, and all those millions that were living at his time, not one had thought of the possibility of a sewing machine, and not one would have constructed a sewing machine. As soon as Howe made one machine, and the conception which first had its origin in his brain, had resulted in the making of a sewing machine and had thus *dragged from the darkness of chaos, one of its secrets and blazoned it forth in the form of actual knowledge* to the world and to the great advantage of its inhabitants, there at once arose an army of imitators and improvers. Once that the original conception had taken place, thousands of imitators could follow and make additions and improvements, but *not one of those imitators would ever have made the original*. They could erect new forms of structures upon the foundation which Howe had built, but *not one of them could have built the foundation*. The foundation was Howe's, and being his, no other one could ever own it. As from its nature, there never could be but the one foundation, and as that belonged to Howe, no other man could ever legally own that foundation, and not owning it, he would have no right to reach out and cover it by asserting that it was the mechanical equivalent of the foundation that he had put in his subsequent improved sewing machine. The Courts should not forget that the foundation of the subsequent machine was Howe's, and did not belong to the party making this subsequent improved machine. The foundation was Howe's, and could not belong to any of the subsequent parties using it. Except for that one single inventor, Howe, there probably would not be a single sewing machine in existence to-day. He was the father, the progenitor of the whole family of sewing machines, and without a first parent, the family would never have been. The distinction between the discoverer of the original principle of the first machine and the limited inventions of improvers of things already in existence, can never be lost sight of by the Courts without running riot in rendering unjust decisions. The Supreme Court, in its decisions, keeps this distinction steadily in view. The application of this distinction is, in part and as far as it goes, the application of "*the state of the art.*"

Suppose after such first original machine is constructed, a second inventor who never did and never would have thought of building such machine, comes along and sees it.

In seeing the machine operate, he discovers that by changing some parts or adding another element, he can make the machine

do more work than it did before. He makes the improvement and takes out his patent for it, and in such patent claims his improved machine. It is easy to see in such case, that while the second inventor makes a better machine than did the first inventor, he nevertheless would not be entitled to reach out and cover as infringements of his patent for an improved machine, the method and mode of operation which was contained in the first machine; because such method and mode of operation was not only not invented or discovered by him, but he had found it ready made and put in practice by the first inventor who already had a patent that covered it. One of the principal objects of proving the state of the art, is to ascertain just what the patentee has invented, and to allow his to cover mechanical equivalents to the extent that he has introduced any new mode of operation. We will refer to this subject and cite authorities pertinent thereto later.

We refer to this state of the art here for the purpose of impressing upon the mind of the Court, the fact that in the case of *Burt vs. Evory*, the Supreme Court did not decide that the patented improvement had been anticipated. On the contrary, on page 358, the Court says in reference to the patented shoe:

“In the construction of it the vamp, the quarters and the expandible gore flap were cut somewhat *differently, it is true, from like parts of the shoes constructed under the earlier patents referred to, but they subserved the same purposes.*”

This quotation shows that the Supreme Court believed, admitted and held that the improvement which was covered by the patent in the case was in fact new. On the first part of the same page 358, the Supreme Court says:

“It is difficult to see any patentable device or function in the Evory and Heston shoe. It is a mere *aggregation* of old parts, with only such changes of form or arrangement as a skillful mechanic could readily devise, the natural outgrowth of the development of mechanical skill, as distinguished from invention. The changes made by Evory and Heston in the construction of a water tight shoe, were changes of degree only, and *did not involve any new principle.*”

“Their shoe performed no new function. \* \* \* \* It is well settled that not every improvement in an article is patentable. The test is that the improvement must be the product of an original conception. *Pearce v. Mulford*, 102, U. S. 112, 118; *Slawson v. Grand Street Railroad*, 107, U. S. 649; *Munson v. New York City*, 124 U. S. 601 and many other cases. And a mere carrying forward or more extended application of an original idea—a mere improvement in degree—is not invention,” etc.

This case declares that although the different parts which went to make up the shoe, were all combined in one shoe, *yet it was a mere aggregation* of old parts. The appellant and the appellant's

counsel, according to their argument in this case, would have taken the opposite ground and insisted that the shoe constituted a patentable combination of parts. The parts in the shoe which the Supreme Court held to be an aggregation only, were certainly combined together and acted together and each one operated and did its part towards the attainment of one common result, which was an *improved* water tight shoe. Not one of those parts could have been omitted without injury or absolutely destroying the usefulness of the action of the other parts, just as removing one length of a fence destroys the utility of all that remains. Yet each part only performed its own action. The parts were added together and the shoe was made up by the contribution of several different parts, where each part performed its own function only and did not help or assist any other part to perform its function. The action of each several part was its own action only. There was none of that kind of joint action in which the action of each part controlled or affected the action of each and every one of the other parts.

This case of *Burt vs. Ivory*, was cited by the Supreme Court, in the case of *Florsheim vs. Schilling*, in which an action was brought for an infringement of two patents for improvements in corsets, 137 U. S., page 77. On the page last mentioned, the Supreme Court repeats the rule which it before had stated in *Pickering vs. McCullough*, 104 U. S. 310, 318, as to what constitutes a patentable combination. It says:

“In a patentable combination of old elements, *all the constituents must so enter into it as that each qualifies every other.* \* \* \* It must form either a new machine of a distinct character and function, or *produce a result due to the joint and co-operating action of all the elements*, and which is not the mere adding together of separate contributions. *The combination of old devices into a new article, without producing any new mode of operation, is not invention.’*”

The Court then cites ten of its own prior decisions to sustain the position announced. It will be noticed that the foregoing rule *states the distinction* between a combination that is patentable and the mere adding together of separate combinations, which is unpatentable because it constitutes only an aggregation. The rule itself is simple and easy as a rule. It is not always, however, so easy to apply the rule to any given case, as it is to know what the rule is. In many cases, the nature of the combination in the apparatus comes so closely to the line between the two classes of combination, that two Courts of equally good judgment might not be agreed as to which clause of the rule covered the combination found. While the rule is simple, its application may often be doubtful and difficult.

Both of the patents in the said case of *Florsheim vs. Schilling*, were declared invalid.

The following is one of the cases decided by the Supreme Court in which the law of aggregations has been applied *where the devices*

acted in the same machine, but yet were held not to constitute a patentable invention. The case is not anything like the pencil case where there was a rubber upon one end of the pencil which might be used to rub out the mark which was made by the pencil lead at the other end, since in that implement all of the elements were not in use at the same time. The citation which we make applies to a machine in which *all of the elements acted together and at the same time*, but yet were held by the Supreme Court to be an unpatentable aggregation only and not a patentable combination.

In *Royer vs. Roth*, 132 U. S. 201, the patent was for a combination of automatic shifting device with a rawhide fulling machine. In using the machine it was necessary to reverse its motion so as to make it revolve awhile in one direction and then change and revolve awhile in an opposite direction. The machine without the automatic reverser had already been patented and it had been used extensively, reversing it by hand. Joining an automatic reverser to it was a great improvement and made the machine as a whole very much more valuable. The machine controlled the action of the reverser and the reverser in turn controlled the action of the machine. It looked to us like a combination as distinguished from an aggregation. But the Supreme Court decided that "it is a mere aggregation of parts." See 132, U. S. on page 206.

Surely if joining the shifting device to the rawhide machine so that each worked with and controlled the action of the other was only an "aggregation of parts," the adding of the *ordinary* web and foot of a T-rail under the rail head and flange instead of placing the timbers thereunder, as shown in Figure 3, of the patent, was only making an aggregation, and not a patentable combination.

In the case of *Watson vs. Cincinnati Railway Co.*, 132 U. S., 161, the patent was for a yielding grain door in combination with other devices. We do not recite the claims at length, as they are quite lengthy. The Supreme Court held that giving the plaintiff the construction which he was claiming for the patent that it could not be upheld, for the reason that "it does not involve invention, but *consists in a mere aggregation of parts*, each to perform its separate and independent function substantially in the same manner *as before combination* with the other, and without contributing to a *new and combined result.*" The Court further says on the same page—167—"The substitution of the old flexible sliding inside door, reduced in size to correspond with the old inside rigid grain door, *may have required some mechanical skill*, and *may have been new and useful*, but it did not involve the exertion of the inventive faculty, and embraced nothing that was patentable."

Here was admittedly a *new combination* of parts *that was new and useful*. Yet it was not a patentable combination, because *it did not involve invention*, according to the Supreme Court. It is to be observed that the Supreme Court does not hold that those things are

not “*combinations.*” It only holds that they do not involve patentable invention and for this reason they are not patentable.

This question of aggregation, and want of invention to a certain extent, go together. Whatever is an aggregation merely, is always unpatentable, and it is unpatentable because it lacks invention. Other things, however, besides aggregation are patented which also lack invention, but such patents are, of course, also void.

In the case of *Dunbar vs. Myers*, 94 U. S., 187. The patent was the combination of *two* deflecting plates placed at the sides of a circular saw for the purpose of preventing the sawed stuff from bearing against the sides of the saw and expanding the saw kerf, and also for stiffening thin veneer saws. The description of the two deflecting plates are on page 189; they are not precisely alike, but nearly so. Similar machines, with one deflecting plate one side of the saw, had been known and were in use for several years.

The first assignment of error was that the lower Court “erred in holding that there was invention in using *two* deflecting plates “when the use of one was well known.” (See the case at page 192.)

The Supreme Court held that where one plate had been used on one side of the saw that it required no invention, and did not involve invention to put another plate of nearly the same kind, performing substantially the same purposes, upon the opposite side. Beginning on page 195, the Court says as follows:

“Grant that two such plates are in certain cases better than one used alone, still the question arises whether it involves any invention to add the second plate to a machine already constructed with one plate. Beyond doubt, every operator who had used a machine having one deflecting plate knew full well what the function was that the deflecting plate was designed to accomplish, and the reasons for placing it at the side of the saw are obvious to the understanding of every one who ever witnessed the operation of the circular saw. Ordinary mechanics know how to use bolts, rivets and screws, and it is obvious that any one knowing how to use such devices would know how to arrange a deflecting plate at one side of a circular saw which had such a device properly arranged on the other side, it being conceded that both deflecting plates are *constructed and arranged precisely alike, except that one is placed on one side of the saw and the other on the opposite side.* Both are attached to the frame in the same manner; nor is it shown either in the specification or drawings that there is anything peculiar in the means employed for arranging the deflecting plates at the sides of the saw, or in attaching the same to the frame. Both are alike, except that the outer end of the one on the same side as the strengthening plate projects farther from the saw than the inner end and that the other is rather smaller in diameter, and that the ends project about an equal distance from the saw.”

The Court then cites many cases illustrating what is a lack of patentable invention. On pages 198 and 199 the Court throws in a statement with regard to proof of the state of the art and what it is admitted to show.

On page 200 the Court further says:

“For these reasons, we are all of the opinion that the claim of the improvement described as the employment or use of two deflecting plates, one placed on each side of the circular saw, for the purposes set forth in the specification, is void, *because it does not constitute a patentable invention.*”

This case of *Dunbar vs. Myers* has been repeatedly mentioned with approval by the Supreme Court in subsequent cases, and it is cited as an authority upon the point as to what does and what does not constitute patentable inventions. in *Roemer vs. Simon*, 95 U. S., 218; *Stawson vs. Grand St. R. R. Co.*, 107 U. S., 653; *Mahn vs. Harwood*, 112 U. S., 358; and in *Morris vs. McMillin*, 112, U. S. 249.

In *Dunbar vs. Myers*, there was *mechanical action* in the elements covered by the combination, while in the appellant's rail there is *no action whatever*. There was more reason for holding the combination patentable in *Dunbar vs. Myers* than there is in the present case for holding the rail patentable, for the reasons that in the former the devices were mechanical operating devices which worked simultaneously and together and produced *one general result*, that of sawing lumber. While in the appellant's rail, the elements, *i. e.*, the various forms and location of the parts which make up the rail have *no mechanical action whatever, do not operate together, nor do they operate to produce one general result even.*

The case cited of *Dunbar vs. Myers* covers, perhaps, a case of mere *duplication* more than it does of *aggregation*. Still this duplication was strictly an aggregation and the case is in point both an account of the general principles presented in it and as showing that making the two shoulders on the opposite side of the web, against which the upper edges of the fish plates would bear, of the same height constituted, only a duplication and no invention.

The following are some of the further authorities upon aggregation:

*Hendy vs. Miners' Iron Works*, 127 U. S., 370, was a case originally tried in the Circuit Court in California and decided for the defendant. The complainant appealed from the decision and the Supreme Court affirmed the decision. The patent was for an improvement in ore-stamp feeders. The first claim of the patent, which was the one asserted to be infringed, was as follows:

“The feeding cylinder, I, mounted upon the movable timbers, H H, substantially as and for the purpose above described.”

The Supreme Court held that the union of the parts in the machine was merely an aggregation. On page 375, the Court

says:

“Moreover, there is *no patentable combination* between the rollers which make the timbers movable and the feeding cylinder I, mounted upon the timbers. *The union of parts is merely an aggregation.* The feeding cylinder, mounted upon timbers which have rollers, *operates no differently from what it does when mounted upon timbers which have no rollers.* *Hailes v. Van Wormer*, 20 Wall., 353, 368; *Reckendorfer v. Faber*, 92 U. S., 347, 357; *Pickering v. McCullough*, 104 U. S. 310, 318; *Bussey v. Excelsior Mfg Co.* 110 U. S., 131, 146. There is nothing patentable in the aggregation.”

In *Beecher Mfg Co. vs. Atwater Mfg Co.* 114 U. S., page 523, is another decision to the same effect. The patent in that case was for an improvement in dies for forming the clip arms for king bolts for wagons. These bolts were made “by taking an iron rod of suitable length, splitting it for about two inches at one end and turning the forks or arms outwards; then heating the rod, placing the body in a hole in a block or die grooved to receive the arms, and striking it with a plane-faced upper die so as to force the arms into and make them take the shape of the grooves, and afterwards placing it between two other dies which give the arms the proper bend to fit them to the axle-tree of a wagon.”

The Court says, page 524, that the claim “for the use in succession, or, in the patentee’s phrase, ‘the series’ of the two pairs of old dies, the one pair to shape the arms of the bolt, and the other to give those arms the requisite curve, does not show any patentable invention. *The two pairs of dies were not combined in one machine, and do not co-operate to one result.* Each pair was used by itself, and might be so used at any distance of time or place from the other; and *if the two were used at the same place and in immediate succession of time the result of the action of each was separate and distinct, and was in no way influenced or affected by the action of the other.* This was no combination that would sustain a patent.”

In Walker on Patents, Section 32, this rule is repeated, that an *aggregation is not invention*,” and cases are cited which sustain the proposition and illustrate it by showing many devices which act simultaneously or in juxtaposition with each other, and assist in doing one general piece of work, but which are decided to be only aggregations and not patentable as combinations.

*Reckendorfer vs. Faber*, 92 U. S., 347, is a leading case upon this point, and has been repeatedly cited by the Supreme Court, as well as by other Courts, as laying down the proper rule. Many cases are cited in that decision on pages 352, 353 and 354. In that case the Court says, on page 357:

“The combination, to be patentable must produce a different force or effect, or result in the combined forces or processes, from that given by their separate parts. There must be a *new result produced by their union; if not so, it is only an aggregation of separate*

“ *elements.*”

In this case the claim was for “The combination of the lead and India rubber or other erasing substance, in the holder of a drawing pencil.”

The Court held that merely using one rod for both the pencil and rubber only amounted to an aggregation, and that it was not a patentable combination of devices.

In this case, however, it is so obvious that the pencil and rubber did not co-operate together to do the same work ; that it does not furnish much of a test as to what, in close cases, would distinguish a patentable combination from an aggregation. The value of the case as an authority consists in the rule above quoted from it, declaring *what a combination must produce in order to be patentable.* The rule, however, was not new with the decision cited. In Section 50 of Curtis on Patents, he says :

“The question will arise, then, in reference to any supposed invention, in what is the novelty to consist, or, in other words, what is the nature of the change that has been effected which will entitle it to the protection of a patent? *It is a leading general principle on this subject, as we have already seen, that there must be something more than a change of form, or of the juxtaposition of parts, or of the external relation of things, or of the order or arrangement in which things are used. The change, or the new combination or relations, must introduce or embody some new mode of operation, or accomplish some effect not before produced.*”

Apply to the two shoulders for the fish plates, one of which is called the offset, C, on opposite sides of the web at equal heights, the language of the Supreme Court in *Pickering vs. McCullough*, in 104 U. S., on page 318, that “in a patentable combination of old elements all the constituents must so enter into it as that each qualifies every other ; to draw an illustration from another branch of the law, they must be joint tenants of the domain of the invention, seized each of every part, *per my et per tout*, and not mere tenants in common, with separate interests and estates. It must form either a new machine of a distinct character and function, or produce a result due to the joint and co-operating action of all the elements, and which *is not the mere adding together of separate contributions.* Otherwise, it is only a mechanical juxtaposition, and not a vital union,” and every appearance of patentable invention disappears.

What is there, we ask appellant’s counsel and the Court, in one of the shoulders that qualifies the action of the other shoulder on the opposite side of the web except the furnishing of means by which the two opposite fish plates, which are themselves but separate contributions, can be made of equal widths. While the fish plates act together they still only act separately. Take away either and the remaining one will do its work just the same. The two of them fur-



nish twice as much strength as one would alone. They do this only because they are duplicated, and being of the same size and strength, two of them are twice as strong as one alone would be. If there is no joint action between the two fish plates except such as results from adding together what each one separately does, surely there can be no joint action between the two separate upper shoulders against which each one of the respective separate fish plates respectively and separately bears.

As a further authority and illustration of what will not constitute a patentable combination, we cite the case of *Bussey vs. Excelsior M'fg Co.*, 110 U. S. 131; and the facts of the case, so far as they apply to the third patent in that suit. They are very instructive. The three patents sued upon in that case were all for improvements in cooking stoves. The third patent was No. 142,934; and the Court commences the discussion of that patent near the bottom of page 142. In that patent the stove had an oven, A, in its middle part a fire box, I, in its front part, and a damper H, by means of which the draft could be changed so as to run through different sets of flues, either over or around the oven as might be desired, and then pass through what was called the base "pan," or "flue shell " D," into and through the exit flue. Whatever other flues the draft passed through around the oven, it must pass through the base pan or flue shell D, and from there through the final exit flue. The base pan is shown in figure 4, on page 143. It is a pan with hooks and devices, by which it is readily attached to and detached from the back of the stove. The bottom of this base pan, when attached to the stove, formed the top of what was called a warming closet, G, which was placed at the back of the stove and underneath the base pan. There were two different devices which served at different times, as might be described, as the top of the base pan, one was the cover, K, shown in figure 3, with two ordinary boiler holes, and another hole for the attachment of an exit flue. This cover might be used if desired. There was connected with the stove a portable reservoir, F, having upon its back part a section of an exit flue marked E. This reservoir, F, is shown in figure 1, page 143, as furnishing the top for the base pan, D, in the stead of the cover before mentioned. When the reservoir, F, was so used the cover mentioned was not used, and the exit pipe, E, came into place so as to allow the draft to pass from the stove through the base pan or flue shell, D, and so on through the exit flue, E, which made a part of the portable reservoir, F.

(This case is in *Brodix American and English Patent Cases*, Vol. 15, pages 77 to 99 and cuts of this stove, with the different parts are shown on page 95.)

There were three claims to the patent. The Court held that in view of the state of the art there was no invention in the first claim of the patent which was for the means used to attach the

base pan to the back of the stove.

Claim 2 was for a combination of the reservoir, F, with the flue, E, at its rear side, with the portable base pan or flue shell, D, and the Supreme Court held that this claim 2 "is merely for an aggregation of parts, and not for a patentable combination."

Claim 3 of the patent was for a combination with a three-flue stove, having a damper, H, arranged as described, of the portable base pan or flue shell, D, and warming closet, G.

This claim also the Supreme Court held to be an aggregation and not a patentable combination. See the decision on first half of page 146, where the Court says :

"Claim 2 is merely for an aggregation of parts, and not for a patentable combination, there being no patentable relation between a portable reservoir with a flue in its rear side and the existence or portability of a base pan beneath it. In claim 3 there is merely an aggregation of parts, there being no patentable relation between a damper for the middle flue of a three-flue stove, and the existence or portability of a base pan or the existence of a warming closet."

Yet the Court will notice that these devices in the stove were joined together, and so joined that the bottom of the portable reservoir formed the top of the base pan, and the heated draft passing through the base pan heated the water in the reservoir. Also, that the bottom of the base pan formed the top of the warming closet, which was warmed by the draft passing through the base pan, and the damper was used to throw the draft through the different sets of flues around the oven before it reached the base pan, which was, in fact, an extension of the flues. If, in cases like this, where the parts are not only joined together, but were the base pan was used for heating both the reservoir and the warming closet, are held by the Supreme Court to be only an unpatentable aggregation, how can it be held that the appellant's T-rail with its aggregation of forms, as covered by Claim 5, is anything more than an unpatentable aggregation, since neither of those forms helps either one of the others to do its work.

In the case of the stove patent, just referred to, it was doubtless the fact that the base pan, D, did have an effect on the reservoir, F, and also on the warming closet, G, because it warmed both of them, but neither of them had any effect on the base pan, D. The draft would pass through the base pan D, just the same whether the reservoir, F, or warming closet, G, was there or not.

The case of *Adams vs. Bellaire Stamping Co.*, 141 U. S., 539, contains facts and law that will illustrate the doctrine of aggregations.

We think we have sufficiently illustrated what the rule is between that kind of combination which is defined by the Supreme

Court as an "aggregation" and which is not patentable and that other kind of a combination that is patentable, and which requires that every device in the combination, shall not only co-act with, but shall also affect the action of every other device in the combination, so that there is a new kind of action made up by the intermingling, uniting and blending into one new action, all of the several actions of all of the several devices and which action produced by such intermingling, uniting and blending, is different from any action that would be produced by the mere adding together of the several actions of the several devices, just as the separated colors of the rainbow are shown in seven bright and distinct shades, when they are joined together at their edges, or in other words, are added one to another, each one of the colors showing its own action in making up the gorgeous arch resplendent in its seven separate colors, represent an aggregation of colors, while those same colors, when they are mingled into one homogenous indivisible whole, and show but the white sunlight which is different from several colors added together, represents the new form of joint action which is different from the addition of several separate actions.

We think also that we have cited examples of the application of the rule sufficiently to show that in this particular case the patented rail is made up simply by adding special forms of the different parts together, and that there is no joint action between the different parts of the rail, or between the special forms of such different parts any more than there was a joint action between the several parts of the Ivory and Heston shoe. The foot of the appellant's rail acts as the foot of the rail only; the web of the rail is an addition to the foot and it acts as a web only; the head and shoulders of the rail for making even fish plating are additions made to the web and foot of the rail, and they act just as the head and shoulders for even fish plating have always acted on ordinary T rails; the flange upon the opposite side from the head is an addition made to the other parts, and acts just as the flanges on ordinary tram rails as well as those on the old California street girder rails acted. The head and web and foot of the rail would perform their duties if the flange was not there, just exactly in the same manner as they perform their duties when the flange is there. The head and flange of the rail perform their duties when resting on and supported by the web and foot of the rail just exactly the same as they perform their duties in the old tram rails when resting upon and supported by the wooden stringers as shown in figure 3 of the patent, and the web and foot perform their duties just exactly the same as the same kinds of webs and feet had been performing similar duties in the ordinary rails of ordinary steam roads for about two generations past. We can safely challenge the appellant's counsel to point out any action or duty performed by the foot

and web of the patented rail that is any ways different from the similar duties that they performed in the ordinary T-rail. If such foot and web perform no duties in the patented rail which they did not perform in the ordinary T-rail, of course there can be no joint action between such foot and web of the patented rail with the flange of the patented rail since there was no such flange on the ordinary T rails; and if there was a new joint action between the foot, web and flange of the patented rail, then such foot and web must do something different in the patented rail from what they did in the prior T rail. In the following list of cases the patents were decided to be invalid, some for one reason and some for another. It would extend this brief to an impracticable length to analyze and discuss the whole of such cases in detail, and we think we have analyzed as many of the cases as is necessary. The Court of course can consult as many of the said list of cases as it desires, and in them will find a confirmation of the rules of decision which we have already presented.

*Hailes vs. Van Wormer*, 20 Wall., 353-375.

*Reckendorfer vs. Faber*, 92 U. S., 347-358.

*Pickering vs. McCulloch*, 104 U. S., 310-319.

*Bussey vs. Excelsior Manufacturing Co.*, 110 U. S., 131, 146.

*Tack Co. vs. Two Rivers Manufacturing Co.*, 109 U. S., 117.

*Phillips vs. City of Detroit*, 111 U. S. 604.

*Stephenson vs. Brooklyn Railroad Company*, 114 U. S., 149.

*Beecher Manufacturing Co. vs. Atwater Manufacturing Co.*, 114 U. S., 523.

*Heating Co. vs. Burtis*, 121 U. S., 286.

*Thompson vs. Boisselier*, 114 U. S., 1, 12.

*Atlantic Works vs. Brady*, 107 U. S., 192, 200.

*Yale Lock Man. Co. vs. Greenleaf*, 117 U. S., 554, 559.

*Pomace Holder Co. vs. Ferguson*, 119 U. S., 335, 338.

*Pearce vs. Mulford*, 102 U. S., 112, 118.

*Slawson vs. Grand Street Railroad*, 107 U. S., 649.

*Munson vs. New York City*, 124 U. S., 601.

*Hall vs. McNeale*, 107 U. S., 90.

*Gardner vs. Herz*, 118 U. S., 180.

*Holland vs. Shipley*, 127 U. S., 396.

*Pattee Plow Co. vs. Kingman*, 129 U. S., 294.

*Brown vs. District of Columbia*, 130 U. S., 87.

*Day vs. Fairhaven and Westville Railway Co.*, 132 U. S., 98.

*Watson vs. Cincinnati &c., Railway Co.*, 132 U. S., 161.

*Marchand vs. Emken*, 132 U. S., 195.

*Hill vs. Wooster*, 132 U. S., 693.

*French vs. Carter*, 137 U. S., 239.

*County of Fon du Lac vs. May*, 137 U. S., 395.

*May vs. County of Juneau*, 137 U. S., 408.

*Busell Trimmer Co. vs. Stevens*, 137 U. S., 423.

Some latter cases we have cited further back in this brief.

In the case of *St. Germain vs. Brunswick*, 135 U. S., 227, the Supreme Court held that the patent did not cover any patentable invention. The case was appealed from the California Circuit Court.

Brunswick was the owner of the patent and was the complainant in the lower Court. The interlocutory decree, sustaining the patent and granting the injunction, was rendered by his Honor, Judge Sabin. After an accounting had been had the case again came up on final hearing before his Honor, Judge Sawyer, and the original interlocutory decree was made final. The defendant, St. Germain appealed.

The patent was on a revolving cue rack. Before the alleged invention, cue racks had been made stationary. The patentee conceived the idea that they would be better if they were made to revolve, and he accordingly made them that way, and took out his patent for the revolving cue rack.

The state of the art showed that table castors and table tops had been made revolving and were used to bring around dishes and decanters in substantially the same way that the revolving cue racks was used to bring around the cues when it revolved. The Supreme Court held that in view of the state of the art, it only required mechanical skill to make the cue rack revolving, and that the patent was void.

It will be noticed in the foregoing case that the patent was not anticipated. The patentee was the first to make cue racks revolving. But as it was a well-known method of constructing other machines whose general purpose was the same, that of bringing around within easy reach the various articles placed thereon, it required no invention to construct billiard cue racks upon this well-known method. The case is instructive, not only as showing a distinction between invention and the application of mechanical skill in the construction of new things, but it is a valuable case as showing an application of *the state of the art for the purpose of ascertaining whether the thing which is new and covered by the patent constitutes a patentable invention or not*. The revolving cue rack was new and it was covered by the patent. Still because it was known how to make other things revolving and perform the same general kind of services, that of bringing around within easy reach the articles placed upon them it did not involve invention to so form cue racks that *they* would hold the

ences and bring them around within easy reach in the same general way.

In order to be perfectly fair with the Court in discussing this question we will present the prominent cases decided in which the Supreme Court has held that the patents did cover patentable inventions, and thus point out in that line of decisions the rules by which patentable inventions are to be distinguished from those changes and improvements which are not patentable.

The fundamental rules are stated in the two following cases next cited. In the case of *McCormick vs. Talcott*, 20 Howard (in which the patent was on a divider on a reaping machine), on page 405, the Supreme Court says:

“ *If he be the original inventor of the device or machine, called the divider, he will have a right to treat as infringers all who make dividers operating on the same principle, and performing the same functions by analagous means or equivalent combinations, even though the infringing machine may be an improvement of the original, and patentable as such. But if the invention claimed be itself but an improvement on a known machine by a mere change of form or combination of parts, the patentee cannot treat another as an infringer who has improved the original machine by use of a different form or combination performing the same functions. The inventor of the first improvement cannot invoke the doctrine of equivalents to suppress all other improvements which are not mere colorable invasions of the first.*”

We ask the Court to notice the distinction in the foregoing quotation between the first *inventor* of the device and the first *improver* of the device *after the first inventor has created it*. The first inventor is the creator of the machine and he may invoke the doctrine of mechanical equivalents of the entire machine and all parts of it when used in the machine. This is because his invention was of the whole machine and all its parts as used in the machine. The first improver on the machine could do no more than make some change in what he already saw. His invention must of necessity be a very limited one unless he could make a change that would give the machine or some part of it a new mode of operation. We are not, however, speaking of such changes but only of those changes which are of no benefit (and such changes probably comprise three-fourths of all the so-called inventions for which patents are granted) or which improve the machine without creating any new mode of operation but are among some of the classes which are shown in the Supreme Court decisions that we have referred to where the patents have been held to be entirely void, or are given a narrow construction that prevented them from covering mechanical equivalents. The first *improver's* invention must be of a change in what already existed. The subsequent improvers may make changes of still less importance and some of them are pretty sure to be changes for the

worse. Such is very often the case in practice. It is also very often the case in practice that those patentees who have done nothing but make a change for the worse are the very one that insist most strongly, that their patents should be broadly construed, so as to cover the principle of operation of the entire machine to which their change applies. They are obliged to so insist for the reason that, their change being only for the worse, *no one will use it*, and their patents for such changes *can only be made valuable by swinging it over some other improvement which they did not make*. They therefore attempt to swing their worthless patent away from the worse than worthless change which they have made and patented as an invention, by the application of the doctrine of mechanical equivalents. The injustice of permitting this to be done is apparent.

Is not the present case a fair illustration of one of the cases last mentioned. The change made in rails by the patentee is a change that so far as the evidence shows *no one uses*. This is a fact which shows that it was a change for the worse. The appellant asserts an infringement of the fifth claim only. The fifth claim by its terms covers the combined tram and T-rail *only when the web, E, is located relatively to the flange, A, and head, B, as described in the patent, which is with the head entirely to the left of a vertical line rising from the web*. The appellee's rail *does not have the web located relatively to the flange and head as described in the patent*. But the appellant's counsel say that while this is true the location in appellee's rail is an equivalent one and therefore it is substantially, the same location. In saying this, the appellant ignores the fact that *his "invention" in respect to such location consists entirely in making a change of this relative location so as to have the web at one side of the head, in old rails in which the said relative location of the web head and the flange were exactly the same as in the appellee's rails*. In the appellee's rails the relative location of the web head and flange are *exactly the same as they were in the old California Street rail*, that is, with the head directly over the web and the flange to the right of the web. If the relative location of the web, head and flange when the head is directly over the web is the equivalent of the relative location of the parts when the head is to the left of the web, the result follows that the change made in this respect by the patentee was only substituting his new relative location of the parts, which substitution was the equivalent of the relative location of the parts as they were already in use.

In this way the appellant is seeking to make the *old* "relative location" of the parts, an infringement of his *new* "relative location" of the same parts. This is nearly the same thing that was attempted in the case of *McCormick vs. Talcott*. In that case on page 407, the Supreme Court says in regard to such attempt: "This attempt to treat the earlier and better device used by defendant as an infringement of a later device to obviate a difficulty unknown

“ to the first, is an application of the doctrine of equivalents which needs no further comment.”

The last case cited, *McCormick vs. Talcott*, was decided as early as 1857; over thirty-four years ago.

The next case we refer to which contains a restatement of the same rule of law with regard to the distinction between original inventors and improvers is that of the *Railway Co. vs. Sayles*, 97 U. S., pp. 556, 557, where the Supreme Court says:

“ In such cases, if one inventor precedes all the rest, and strikes out something which includes and underlies all that they produce, he acquires a monopoly, and subjects them to tribute. But if the advance towards the thing desired is gradual, and proceeds step by step, so that no one can claim the complete whole, then each is entitled only to the specific form of device which he produces, and every other inventor is entitled to his own specific form, so long as it differs from those of his competitors, and does not include theirs. These general principles are so obvious, that they need no argument or illustration to support them.”

We now cite other cases, in which the inventions were upheld by the Supreme Court, of comparatively recent dates, and in those decisions appear the reasons why the inventions were held to be patentable and why they deserved the full protection of the law and Courts.

In the cases of *Morley Machine Co. vs. Lancaster* 129, U. S., page 263; on page 273 the Court says:

“ Morley having been the first person who succeeded in producing an automatic machine for sewing buttons of the kind in question upon fabrics, is entitled to a liberal construction of the claims of his patent. He was not a mere improver upon a prior machine which was capable of accomplishing the same general result, in which case, his claims would properly receive a narrower interpretation. This principle is well settled in the patent law, both in this country and in England. Where an invention is one of a primary character, and the mechanical functions performed by the machine are, as a whole, entirely new, all subsequent machines which employ substantially the same means to accomplish the same result are infringements, although the subsequent machine may contain improvements in the separate mechanisms which go to make up the machine.

“ In *McCormick v. Talcott*, 20 How., 402, 405, the inquiry was whether McCormick was the first person who invented, in a reaping machine, the apparatus called a divider, performing the required functions, or whether he had merely improved an existing apparatus, by a combination of mechanical devices, which performed the same functions, in a better manner. This Court, speaking by Mr. Justice Grier, said: ‘ If he (the patentee) be the original inventor of the device or machine called the divider, he



“ ‘will have a right to treat as infringers all who make dividers  
 “ ‘operating on the same principle, and performing the same func-  
 “ ‘tions by analogous means or equivalent combinations, even though  
 “ ‘the infringing machine may be an improvement of the original,  
 “ ‘and patentable as such. But if the invention claimed be itself  
 “ ‘but an improvement on a known machine by a mere change of  
 “ ‘form or combination of parts, the patentee cannot treat another  
 “ ‘as an infringer who has improved the original machine by use of  
 “ ‘a different form or combination, performing the same functions.  
 “ ‘The inventor of the first improvement cannot invoke the doctrine  
 “ ‘of equivalents to suppress all other improvements which are not  
 “ ‘mere colorable invasions of the first.’

“ So, also, in *Railway Co. v. Sayles*, 97 U. S., 554, 556, this Court,  
 “ speaking by Mr. Justice Bradley, said, in regard to brakes for  
 “ eight-wheeled railroad cars: ‘Like almost all other inventions,  
 “ that of double brakes came when, in the progress of mechanical  
 “ improvement, it was needed; and being sought by many minds,  
 “ it is not wonderful that it was developed in different and indepen-  
 “ dent forms, all original, and yet all bearing a somewhat general  
 “ resemblance to each other. In such cases, if one inventor pre-  
 “ ceeds all the rest, and strikes out something which includes and  
 “ underlies all that they produce, he acquires a monopoly, and subjects  
 “ them to tribute. But if the advance towards the thing desired is  
 “ gradual, and proceeds step by step, so that no one can claim the  
 “ complete whole, then each is entitled only to the specific form of  
 “ device which he produces, and every other inventor is entitled to  
 “ his own specific form, so long as it differs from those of his com-  
 “ petitors, and does not include theirs. These general principles  
 “ are so obvious that they need no argument or illustration to sus-  
 “ port them.’

“ The same view was directly applied in *Clough v. Barker*, 106  
 “ U. S., 166, 177, to the Clough patent for an improvement in gas  
 “ burners. The first claim of that patent was for ‘the bat wing  
 “ ‘burner, perforated at the base, in combination with the surround-  
 “ ‘ing tube, substantially as described.’ The second claim read thus:  
 “ ‘In combination with the bat wing burner, perforated at the base  
 “ ‘and surrounding tube, the tubular valve for regulating the sup-  
 “ ‘ply of external gas to the burner, substantially as described.’ It  
 “ appeared that in no prior structure had a valve arrangement been  
 “ applied to regulate the flow of gas in such a combination as that  
 “ covered by the first claim of the patent. It was therefore held,  
 “ that the patentee was entitled to the benefit of the doctrine of  
 “ equivalents, as applied to the combination covered by the second  
 “ claim. In the defendant’s burner, the regulation was made by a  
 “ tubular valve on the outside of the perforations, instead of on the  
 “ inside as in the patent, but performing its work by being screwed  
 “ up or down, as in the patent. This Court said: ‘Although in

“ ‘the Clough structure the burner and surrounding tube revolve  
 “ ‘together in adjusting their position in reference to that of the  
 “ ‘tubular valve, so as to let in or turn off the supply of gas through  
 “ ‘the perforations, and although in the Clough structure the flame  
 “ ‘revolves by the revolution of the burner, and although in the  
 “ ‘defendant’s burners the revolution of the surrounding tube regu-  
 “ ‘lated the supply of gas through such perforations, and neither  
 “ ‘the burner nor the flame revolved, the defendant’s valve arrange-  
 “ ‘ment must be held to have been an equivalent for that of Clough  
 “ ‘to the full extent to which that of Clough goes—involving, per-  
 “ ‘haps, patentable improvements, but still tributary or subject to  
 “ ‘the patent of Clough. It is true that that patent describes the  
 “ ‘tubular valve as being inside of the burner tube. *But Clough was*  
 “ ‘*the first person who applied a valve regulation of any kind to the com-*  
 “ ‘*combination to which he applied it, and the first person who made such*  
 “ ‘*combination ; and he is entitled, under decisions heretofore made*  
 “ ‘*by this Court, to hold as infringements all valve regulations ap-*  
 “ ‘*plied to such a combination, which perform the same office in*  
 “ ‘*substantially the same way as, and were known equivalents for*  
 “ ‘*his form of valve regulation.’ See also, Duff vs. Sterling Pump*  
 “ ‘*Co., 107 U. S., 636, 639.*”

See also, *Western Electric Co. v. La Rue*, 139 U. S., 601.

Since the number of cases in which the Supreme Court has held the patents to be invalid because they did not cover any patentable invention are so largely in the majority there are but comparatively few of the other kind to be found in which the patents were sustained by that high tribunal. This results from the fact that the number of inventions which creates new machines, or new modes of operations in old machines, are so few in number. When the patent office ceases to issue patents for unpatentable changes and improvements the number of patents issued will be very much reduced. The number then issued will probably not be one-tenth of the number now issued. Inasmuch as there have been some decisions of the Supreme Court of comparatively recent date in which the patented invention have been sustained (those which we have herein cited) it would seem strange that the appellant’s counsel did not cite them in their brief, were it not apparent that the decisions, while sustaining the patents involved in the cases, nevertheless contained such descriptions of what inventions are patentable, as excluded from the list the patent of the appellant. Hence the poverty of the appellant’s brief in the citation of Supreme Court decisions which defined what changes and improvements are patentable and what are not. Is not the fact that the appellant’s brief fails to cite the recent decisions of the Supreme Court with the one exception (*McLain vs. Ortmyer*, 141 U. S., 425, which is a decision *directly against the appellant*) a confession on its part that in its judgment those decisions would not sustain its patent?

### NON-INFRINGEMENT.

We might probably have rested our case with entire safety upon the ground of non-infringement. The appellees do not make or use, and if they were the owner of the appellant's patent they would not make or use the patented rail. The patent has six claims to it. *The appellant admits that as to five of those claims, the appellees have not infringed* which of course means that *they have not used the forms which are covered by five of those claims.* This admission on the part of the appellant of course shows that the appellee did *not make the patented rail as an entire rail.*

As the witness Noble states in his testimony, the patentee was unfair when applying for his patent in presenting the patented rail and stating its advantages over the old form of flat rail, which is shown in figure three of the patent. As already stated, the specifications of the patent admit that rails with the general features of both the tram rail and the ordinary T-rail were old and the patentee did not claim them, but confined himself to the form particularly described in the patent. The old California Street rail had both a foot and web and head and flange, and was of the same general character as was the patented rail. Confessedly the California Street rail was older than the patentee's invention and therefore the patent could not cover anything except the difference between the California Street rail and the rail described in the patent.

It is asserted that the appellee's rail infringes the fifth claim of the patent only. The fifth claim is as follows:

“In the combined tram and T-rail described, the web, E, *located relatively to the flange A and head, B, offset at C, as described, whereby a maximum capacity of outside pocket is secured with a minimum quantity of metal consistent with the proper stability of the rail, substantially as set forth.*”

This claim is not infringed unless the form which it covers is used. To obtain a full and accurate description of that form, *we do as the claim does and go to the specification and drawings.* The claim itself contains the words “substantially as set forth,” and in its general language requires that the specification and drawings be referred to for the description of the forms covered by the claim. It is a familiar rule when this is done that the claim must be construed with reference to the specification and drawings. As the Supreme Court said in *Seymour vs. Osborne*, 11 Wallace, on page 547, “where the claim immediately follows the description of the invention, it may be construed in connection with the explanations contained in the specifications, and where it contains words referring back to the specifications, it cannot properly be construed in any other way.” This is a familiar rule and is one that is almost self-evident.

Referring to the specifications and drawings for a description of what is covered by the said fifth claim, and particularly of that por-

tion which requires the web, E, to be “*located relatively to the flange, A, and head, B, as described,*” and we find that this relative location places the head entirely to the left hand of the vertical line of the web, and at the same time it places the upper face of the flange, A, over the whole width of the web.

Right in this connection we call attention to the disclaimer in the specifications of the patent, (Record page 43,) where it says in reference to rails which combine the advantages of the tram rail with the advantages of the T-rails.

“*I am aware that rails embodying the general features above mentioned are old, and I therefore disclaim the same, and confine myself to the form hereinafter particularly described and claimed as new.*”

Now the form *claimed as new* in this fifth claim is a form in which the head is at the left hand of the web. *This form is not in the appellee’s rail.* On the contrary the defendant’s rail has the head located over the web while the flange is to the right of the vertical line of the web. *The form, therefore, which is the only thing covered by the fifth claim is not in the appellee’s rail* and this being so, it cannot infringe the patent.

The appellant called upon Henry L. Breevort as an expert to testify in the case. The following quotation from the cross-examination of the expert shows how absolutely wanting in the appellee’s rail was the form that must result from having “the web, E, located relatively to the flange, A, and head, B,” as required by the fifth claim. The testimony referred to is as follows. Record, pages 23 and 24.

“X. Q. 8. In the patent rail is there any part of the head that is over the web in vertical line?”

“A. No.

“X. Q. 9. In the defendant’s rail is the head in vertical line over the web or not?”

“A. The head is over the web.

“X. Q. 10. Then in the respect referred to in the last two questions is the relative location of the head and web, the same in the defendant’s rail as it is the patented rail?”

“A. It is not.

“X. Q. 11. In the patented rail is the flange in a vertical line over the web?”

“A. Yes.

“X. Q. 12. In the defendant’s rail is the flange in a vertical line over the web?”

“A. No.

“X. Q. 13. Then in this respect is the relative location between the web and the flange the same in the defendant’s rail as it is in the patented rail?”

“A. No.”

In reading this fifth claim of the patent its meaning may be ar-

rived at by leaving out so much of the last three lines as says: "whereby a maximum capacity of outside pocket is secured with a minimum quantity of metal consistent with the proper stability of the rail." There are two reasons why the claim may be better read without the words above quoted. One is, that the words *merely state the result of the form* which is claimed. They do not claim anything in and of themselves. They form no part of any statement of what is claimed and for these reasons *they are in fact no part of the claim proper*. The other reason is that as the appellee uses its rails no pocket is used for the reception or retention of street ballast. Noble's testimony, Record, last half pages 40 and 41. The appellee's rails are riveted fast and tight to the iron frames that are a part of its road bed, and the road bed is laid with paving stones which stand up alongside of the rails and do not fill the pockets, or hollow spaces that come between the foot of the rail and the upper extension formed by the head on one side and the flange on the other. The street bed and paving used with the appellee's rails are exactly the same as were the old California-street bed and paving, and they are not the street bed and paving described in the patent as being benefitted by the form of the patented rail.

Reading the claim by retaining in it all that tells what is claimed and rejected as surplusage those parts which cover nothing, but only describe the effect produced by what is claimed, and the claim will read as follows:

"In the combined tram and T rail described the web E, located relatively to the flange A and head B; offset at C, as described, substantially as set forth."

It will be noticed that the claim *does not cover the rail as a whole*. It only claims something that is "*in the combined tram and T-rail*." What is it that is *in this combined tram and T-rail that is claimed?* It is the "*web, E, located relatively to the flange, A, and head, B, offset at C, as described*." This is what is claimed *and nothing else is claimed*. The claim may be transposed and show perhaps a better connection by reading it as follows: "*The web E, located relatively to the flange, A, and head, B, offset at C, as described in the combined tram and T-rail substantially, as set forth*." Read the claim as we may and it is obvious that its most important factor *is the relative location* between the web and the head and the flange. This change, which was made by the patentee, from the relative location of the corresponding parts in the old rail on California street, was one of the important changes shown in his specifications and was doubtless one of the changes which obtained for him the patent. At any rate it is one of the limitations that is an important part of the claim, and *as he accepted the patent with this limitation as to form, and as in his specifications he disclaimed all other forms except as are "hereinafter particularly described and claimed as new,"* he and his assignees

are bound by the limitations of the claim.

*Keystone Bridge Co., vs. Phoenix Iron Co.*, 95 U. S. on pages 277, 278 and 279.

*Merrill vs. Yeomans*, 94 U. S. 568.

*Railroad Co. vs. Mellon*, 104 U. S., pages 118 and 119.

*Sargent vs. Hall Safe and Lock Co.*, 114 U. S., pages 85 and 86.

*Western Electric Co. vs. Ansonia Co.*, 114 U. S., pages 451 and 452.

*Burns vs. Meyer*, 100 U. S., page 672.

*Yale Lock Co. vs. Greenleaf*, 117 U. S., pages 558 and 559.

Upon the question of non-infringement see also, in addition to the foregoing :

*Werner vs. King*, 96 U. S., pages 229 and 230.

*Clark vs. Beecher Man. Co.*, 115 U. S., pages 86 and 87.

*Duff vs. Sterling Pump Co.*, 107 U. S. page 639.

*McLain vs. Ortmayer*, 141 U. S., which is the very case cited by the appellant in its brief is decisive upon this point. See pages 424 and 425 of the decision. Appellant has quoted from page 425 of the case, but divided the sentence from which the quotation was made. A continuation of the quotation which the appellant has made is as follows, viz :

“ But if the language of the specification and claim shows clearly “ what he desired to secure as a monopoly, *nothing can be held to be “ an infringement which does not fall within the terms the patentee has “ himself chosen to express his invention.*

“ The principle announced by this Court in *Vance v. Campbell*, “ 1 Black, 427, that where a patentee declares upon a *combination of “ elements which he asserts constitute the novelty of his invention, he “ cannot in his proofs abandon a part of such combination and main- “ tain his claim to the rest*, is applicable to a case of this kind where “ a patentee has claimed more than is necessary to the successful “ working of his device.”

In the case at bar, the patentee has claimed in the fifth claim *a combination of forms*. The claim is not for any one of the several local forms that find their several places in the rail, *but it is for a combination of forms*. To comply with the calls of that claim the very first requirement is “ the web, E, *located relatively to the flange A, and to the head, B.*” This is the first thing to be found in the appellee’s rail before there is any need of looking to see whether the head, B, is offset at C, or not. The language of the claim does not seem to be clear as to whether the patentee means to say that it is the *head* that is “ offset at C,” or whether it is the *web* that is “ offset at C.” This is the only thing that is doubtful about the claim, and this is immaterial. The offset is located and whether it is called an offset of the head or an offset of the web or an offset of both, makes no difference. Whatever it may be that is “ offset at C,” there is no uncertainty as to what “the web E, *located* relatively to

the flange, A, and head, B," means. The specifications explain these relative *locations* fully.

Appellant's brief gives us but very little to reply to. It cites but three cases and those are cited as authority to show, that, as a proposition of law, one claim cannot be so construed as to make that claim cover the same thing that is claimed in another claim. (Page 7 of the brief.) A reference to the authorities cited by appellant shows that the statement in the brief is altogether too strong. The rule which those authorities apply is simply to construe the different claims so that they shall not cover the same thing if this can fairly be done. To this rule *as stated in the citations* of appellant, we have no objection to make.

Whatever the rule may be, we fail to see its application to the second and fifth claims of the patent.

The second claim of the patent is *for the rail as a whole entire rail*, having the head located with reference to the center line of the web, reinforced as at C, and proportioned with reference to all the parts of the rail as described, so that the metal shall be distributed to the several parts, and in such manner as to equalize the contraction in cooling. This claim is for the rail entire. It says:

"A combined tram and T-rail," &c. It is for the entire rail with its parts *proportioned* as described.

The second claim being for the entire rail, the fifth claim calls for certain things that are *contained in* the "combined tram and T-rail" that the second claim calls for. The fifth claim begins by saying: "*In the combined tram and T-rail described*, the web, E, located relatively to the flange, A, and to the head, B, off-set at C, as described," &c.

Now, what is this fifth claim, except claiming certain features that are in the combined tram and T-rail that is covered by claim two? Claim two is for the combined tram and T-rail as a whole with its several parts *proportioned* as described. Claim five is for certain parts of the same rail *located* in a certain manner. The second claim calls for *proportions* of all the parts, while the fifth claim calls for particular *locations* of the parts.

The appellee's rails, however, do not have either the proportions of the several parts, nor do they have the locations of the parts called for, and in whatever manner the claims may be construed *within the terms and language which they employ* there can be no infringement of either of them by the appellee's rails.

The appellant has much to say about even fish-plating, and capacity of outside pocket. There is no evidence showing either of these features to be of the least importance. The appellee's rails have not been used so as to test the importance of either of these features. There is no ground, we think, for supposing that these features are of any importance in practice. Their importance is exhausted in using them as the basis of appellant's argument.

Whatever they may be worth as a basis for appellant's argument we do not think they have any further value.

Look, for instance, at figures B and E and H, of appellant's brief and see the small amount of space that the cutting away of the shaded metal would furnish for street ballast. In a full sized rail, the space gained for street ballast would not exceed one half of a square inch. What difference would a full square inch, more or less, of street ballast amount to in practice? It would never be noticed. Again; does it not seem a little out of reason to imagine that the action of street ballast could possibly be any better than the solid metal of the rail, when used for the mere purpose of filling that space? It certainly looks to the ordinary mind as though the solid metal would be much more solid and much more certain to remain in its place than would be the street ballast, and there is no evidence in the case to show to the contrary.

The rails are naturally cut away in those places to make a symmetrical rail, and not waste metal uselessly. Even if the patentee intended to admit—which we do not believe to be the fact—that rails made like figure A of appellant's brief were old, it would be an admission of something that never occurred in fact. No rail manufacturers have ever yet been guilty of making such a useless waste of metal in manufacturing rails.

See Noble's evidence, Q's. 19 and 20, page 32 of the Record.

Not only do the appellees not use the form covered by the fifth claim of the patent, but they do not so use any form as to obtain the advantages which the *patent* says results from those forms. Even the expert does not testify, nor does the appellant's brief so claim. The expert does say that the appellee's rail possesses the advantages of the patented *rail*. But what seems peculiar is that the advantages which are pointed out as possessed by the TWO RAILS *by the expert* are not the advantages pointed out *by the patent, nor are they any of the advantages which result from the changes which the patentee made*, but they are advantages which were in the old California-street rail or in the ordinary T-rail. The advantages of the patented rail are stated by the expert to be that "it is adapted to be placed on a sleeper below the street level so that the paving can be brought up to it—it has a head for the bearing of the wheel, a flange which permits ordinary street traffic, a vertical web and foot," etc. Up to this point no advantages are stated except what were used in the old California-street rail. That rail was adapted to be placed on a sleeper below the street level; and it *was* placed below the level of the street and the paving was brought up to it just as the paving is brought up to the appellee's rails. The old California-street rail is there now just as it was before the patented rail was thought of, and an inspection of that rail now and a comparison of it with the appellee's rail on the Sutter street road will show that in this matter of advantages



they are alike. Both are placed below the street level and are paved in alike. Both have heads for bearings for the car wheels alike. Both have flanges alike which permit ordinary street traffic. Both have horizontal feet and vertical webs. Both also have pockets between the foot and web which *might* be used for the reception and retention of street ballast, *but which never were so used by either*. As to all these so-called advantages *none of them are due to the patent*. They all existed before, although the pockets were a little less in the old rail because it was not so high. It had a narrower web. If the web in the California-street rail had been made as high as in the patented rail then the said pocket would have been greater since no part of the space would have been occupied by the offset, as explained in Mr. Noble's testimony. Record, side page 54. If even fish plating is any advantage the old ordinary T-rail possessed it.

Another advantage, so-called, which the patent expatiates largely upon is the forming of the head, web and flange so that there is an equal amount of metal in each, and thereby securing equal shrinkage and avoiding the necessity for "cambering" the rails. While it is not true that the patent does this it is true that the appellee's rail has no such distribution of metal and it had to be "cambered" more than had ordinary rails. This is because the head extends over the web and makes the mass of metal very great and heavy from the top of the head to the bottom of the flange. Both from the evidence of Mr. Noble and from the explanations of the patent it is apparent that the appellee's rail requires great amount of cambering.

See Noble's testimony. Record, side pages 54 and 55.

From all this it is apparent that the attempt to show that the appellee's rail is indebted to the *patent* for its advantages, is unsuccessful. While the appellant has labored to show that the two *rails* possess in many respects the same advantages, it has stopped short of proving that those advantages resulted from the alleged invention and were not advantages which belonged to the older rails or that they were not advantages already enjoyed by the public at large.

Appellees, therefore, ask for an affirmance of the decrees of the Circuit Court in both cases upon the grounds :

1st. That the patent is invalid because it does not cover any patentable invention ; and

2nd. Because the appellees have not infringed the patent.

The opinion of the Circuit Court is in the Record, from page 12 to page 19. (47 Federal Reporter, 586.) To that opinion we refer as an able analysis of the questions involved and an additional authority to those herein before cited.

Respectfully submitted,

M. A. WHEATON,  
I. M. KALLOCH,  
F. J. KIERCE,

*Counsel for Appellees in both cases.*



*In the United States Circuit Court of Appeals for the Ninth Circuit.*

---

THE JOHNSON COMPANY,

Appellant,

vs.

PACIFIC ROLLING MILLS COMPANY,

and

THE JOHNSON COMPANY,

Appellant,

vs.

SUTTER STREET RAILWAY COMPANY.

Nos. 33 & 34.  
Filed July 18, 1892.

---

*Appeal from the Circuit Court of the United States for the Northern  
District of California.*

---

Before MCKENNA and GILBERT, Circuit Judges, and DEADY,  
District Judge.

By the Court,

MCKENNA, J. :

The patent in this case is for a form of street rails.

The patentee in his specifications admits that rails embodying the general features of his rail were old, and we think his special form involved no invention.

It was but an obvious application of what had preceded.

Judgment is therefore affirmed.

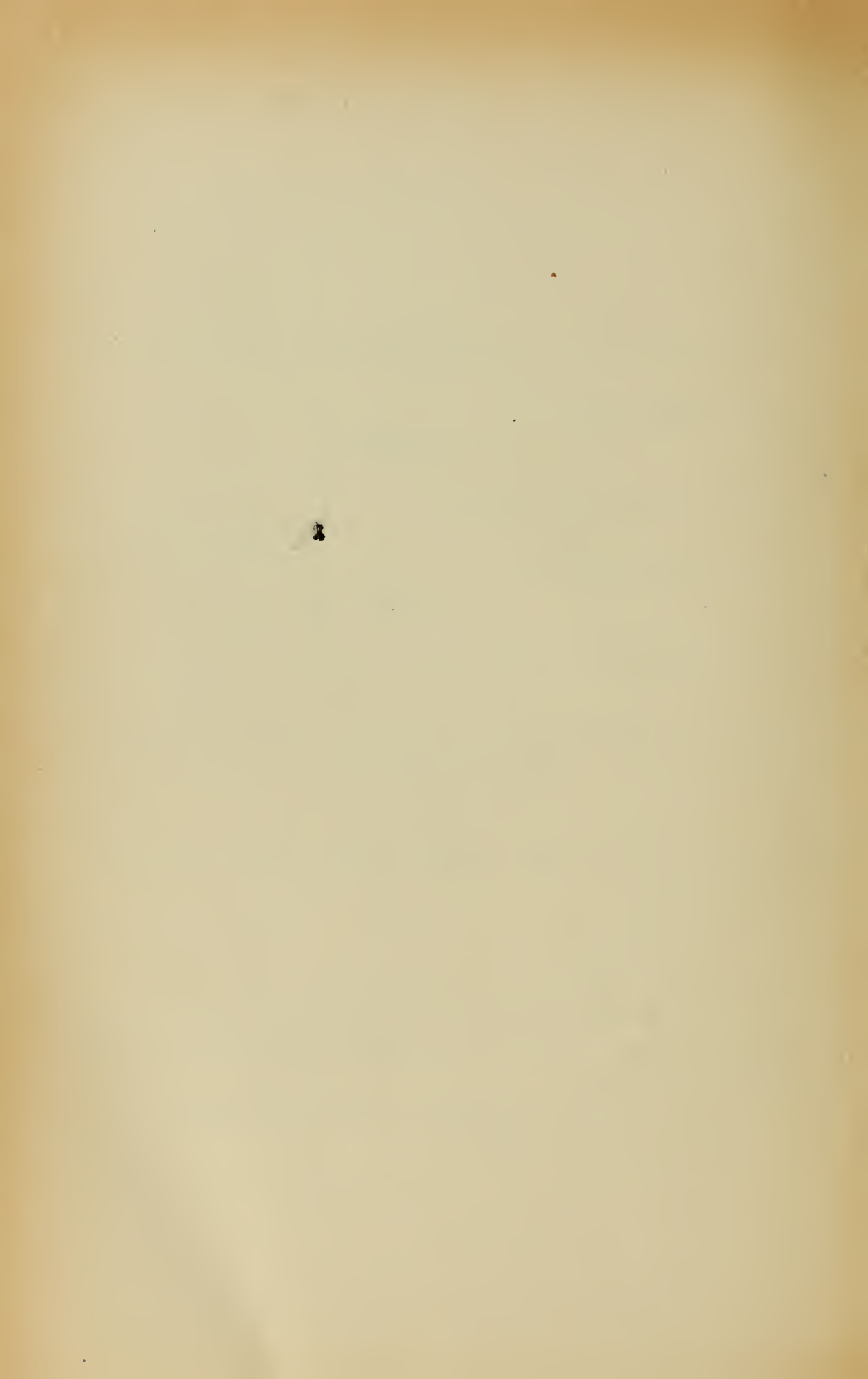

4  
No. 39.

## TRANSCRIPT OF RECORD.

---

UNITED STATES CIRCUIT COURT OF APPEALS,  
FOR THE NINTH CIRCUIT.

OCTOBER TERM, 1891.

---

HUNT BROTHERS' FRUIT PACKING COMPANY,  
*Plaintiff in Error,*

*vs.*

JOHN W. CASSIDY,  
*Defendant in Error.*

---

UPON WRIT OF ERROR TO THE CIRCUIT COURT OF THE UNITED STATES FOR  
THE NORTHERN DISTRICT OF CALIFORNIA

(FILED MARCH 16th, 1892.)

---

*Filed, March* ..... *1892.*

FILED  
MAR 30 1892



## INDEX.

	Original.	Print.
Answer.....	7	4
Assignment of Errors.....	177	122
Bill of Exceptions.....	15	8
Bond of Writ of Error.....	194	133
Certificate to Judgment Roll.....	14	8
Citation.....		135
Declaration.....	1	1
Judgment.....	12	7
Notice of Special Matter.....	8	5
Order extending time to file Record, &c.....		136
Petition for Order Allowing Writ of Error.....	192	132
Summons.....	5	3
Verdict.....	11	6
Writ of Error.....		134





1

*Declaration.*

In the Circuit Court of the United States for the Northern District of California, of the February Term of the Year One Thousand Eight Hundred and Ninety-one.

UNITED STATES OF AMERICA,  
NORTHERN DISTRICT OF CALIFORNIA. } ss.

John W. Cassidy of the City of Petaluma, County of Sonoma, in the State of California, and a citizen of the said State of California, plaintiff in this action by Langhorne & Miller, his attorneys, complains of the Hunt Brothers' Fruit Packing Company, a corporation organized and existing under and by virtue of the laws of the State of California, and having its principal place of business at the City of Santa Rosa, County of Sonoma, in the said State of California, and the Northern District thereof, of a plea of trespass on the case.

For that heretofore to-wit: On and prior to the 8th day of March, A. D. 1875, plaintiff was the original and first inventor of a certain new and useful invention, to-wit: an improvement in Drying Apparatus.

That said invention related to an improved device for dessicating fruit and other substances by means of artificial heat, and consisted among other things, of a novel means of moving the trays on which the fruit is held within the drying chamber from the time it is admitted until it is removed therefrom, as will more fully appear from the letters patent therefor hereinafter set out to which reference is hereby made for a fuller description.

2 And for that the said invention was new and useful, and was not known or used by others prior to the invention thereof by the said plaintiff, and at the time of his application for letters patent therefor, as hereinafter mentioned, had not been in public use or on sale in the United States for two years, nor abandoned, nor proved to have been abandoned.

And for that the said plaintiff, being as aforesaid the inventor thereof, did on the 8th day of March, A. D. 1875, make application to the Government of the United States for the issuance to him of letters patent for said invention, and thereafter, to-wit: on the 25th day of January, A. D. 1876, after proceedings duly and regularly had and taken in the matter of said application, letters patent of the United States were granted, issued and delivered to said plaintiff for said invention, granting and securing to him, his heirs and assigns for the full term of seventeen years from said last-named day the sole and exclusive right, to make, use and vend said invention throughout the United States and territories thereof.

And for said letters patent were issued in due form of law under the Seal of the Patent Office of the United States, and were signed by the Secretary of the Interior, and were countersigned by the Com-

missioner of Patents of the United States, and bear date the day and year last aforesaid, and were numbered No. 172,608, all of which will more fully appear by said letters patent, which are ready in Court to be produced by plaintiff, or a duly certified copy thereof, and of which he hereby makes profert.

And for that prior to the issuance of said letters patent all proceedings were had and taken which were required by law to be had and taken previous to the issuance of letters patent for new and useful inventions.

And for that ever since the issuance of said letters patent plaintiff has been and now is the sole and exclusive owner and holder of said letters patent, and the invention therein claimed, for, to, in and throughout the United States of America and Territories thereof.

And for that since the issuance of said letters patent in the exercise of the rights and liberties thereby granted, the plaintiff has made, used and sold the improvements so patented, and had and maintained, until the infringement hereinafter complained of, possession of said invention under and by virtue of said letters patent, and has never acquiesced in any invasion or infringement of his said rights.

Yet notwithstanding the premises the defendant having full knowledge thereof, and in violation of the exclusive rights and privileges secured by said letters patent, and utterly disregarding the same and contriving and intending to injure and damage the plaintiff, since the issuance of said letters patent and prior to the commencement of this action, without the license or consent of plaintiff, but contrary thereto in the State of California and the Northern District thereof, has wrongfully and unlawfully made, used and sold large numbers of machines containing and embracing the inventions described and claimed in and by the said letters patent.

That said machines so made, used and sold by defendant are infringements upon said letters patent No. 172,608 and were made according to the specification thereof; all contrary to law and the form, force and effect of the Statutes of the United States in that behalf made and provided.

4. Whereby and by reason of the premises and the infringement aforesaid the plaintiff has been greatly injured and damaged and deprived of large royalties, gains and profits which he would have derived from practicing said invention, and has sustained actual damages thereby in a large sum, to-wit: five thousand dollars (\$5,000).

Wherefore, by force of the Statutes of the United States a right of action has accrued to plaintiff to recover the said actual damages and such additional amount not exceeding in the aggregate three times the amount of such actual damages as the Court may see fit

to adjudge and order, beside costs of suit.

Yet the defendant, though often requested, has never paid the same nor any part thereof, but has refused and still does refuse so to do, and therefore plaintiff brings this suit.

LANGHORNE & MILLER,

*Attorneys for Plaintiff.*

(Endorsed :) Filed July 9, 1891. L. S. B. Sawyer, Clerk.

5

*Summons.*

United States of America.

Circuit Court of the United States, Ninth Circuit, Northern  
District of California.

J. W. CASSIDY,

Plaintiff,

*vs.*

HUNT BROTHERS' FRUIT PACK-  
ING COMPANY (corporation),

Defendant.

Action brought in the said Cir-  
cuit Court, and the declaration  
filed in the office of the Clerk of  
said Circuit Court, in the City  
and County of San Francisco.

The President of the United States of America, Greeting: To Hunt  
Brothers' Fruit Packing Company (a corporation), defendant:

You are hereby required to appear in an action brought against  
you by the above named plaintiff, in the Circuit Court of the  
United States, Ninth Circuit, in and for the Northern District of  
California, and to file your plea, answer or demurrer to the declara-  
tion filed therein (a certified copy of which accompanies this sum-  
mons), in the office of the Clerk of said Court, in the City and  
County of San Francisco, within ten days after the service on you  
of this summons—if served in this county; or, if served out of this  
county, then within thirty days—or judgment by default will be  
taken against you.

The said action is brought to recover the sum of \$5,000 damages  
from you by reason of the alleged infringement by you upon letters  
patent of the United States issued to plaintiff on January 25, 1876,  
and numbered 172,608, for a Fruit-drier, together also with costs  
and treble damages, all of which will more fully appear from the  
declaration on file, to which reference is hereby made, and

6 if you fail to appear and plead, answer or demur, as herein  
required, your default will be entered and the plaintiff will  
apply to the Court for the relief demanded.

Witness, the Honorable Melville W. Fuller, Chief Justice of the  
Supreme Court of the United States, this 9th day of July, in the  
year of our Lord one thousand, eight hundred and ninety-one,  
and of our independence the 116th.

[SEAL.]

L. S. B. SAWYER,

*Clerk.*

(Endorsed :)

 UNITED STATES MARSHAL'S OFFICE, }  
 NORTHERN DISTRICT OF CALIFORNIA. }

I hereby certify that I received the within writ on the 9th, day of July, 1891, and personally served the same on the 10th, day of July, 1891, on Hunt Brothers Fruit Packing Company, by delivering to and leaving with J. H. Hunt, President of said Hunt Brothers Fruit Packing Company, said defendant named therein personally, at the County of Sonoma, in said district, a certified copy thereof, together with a certified copy of the bill of complaint, certified to by J. H. Miller, pl'ff's att'y, attached thereto.

W. G. LONG,

*U. S. Marshal.*

By A. A. WOOD,

*Deputy.*

San Francisco, July 11th, 1891.

Filed July 11, 1891.

L. S. B. SAWYER,

*Clerk.*

7

*Answer.*

In the Circuit Court of the United States, for the Ninth Circuit,  
 Northern District of California.

J. W. CASSIDY,	}
Plaintiff,	
vs.	}
HUNT BROTHERS' FRUIT	
PACKING COMPANY,	
Defendant.	

Now comes the said defendant and denies generally and specifically each and every allegation contained in the plaintiff's complaint, on file herein, and says that it is not guilty of the grievances therein charged against it or any or either, or any part thereof, and of this the defendant puts itself upon the country.

Wherefore, defendant demands judgment for its costs.

WHEATON, KALLOCH &amp; KIERCE,

*Attorneys for Defendant.*

(Endorsed :) Service of the within answer and receipt of a copy thereof admitted this 8th day of August, 1891.

LANGHORNE &amp; MILLER,

*Attorneys for Plaintiff.*

Filed 8th day of August, A. D. 1891.

L. S. B. SAWYER, *Clerk.*

*Notice of Special Matter.*

In the United States Circuit Court, Northern District of California.

J. W. CASSIDY,	} Plaintiff,
vs.	
HUNT BROTHERS' FRUIT	} Defendant.
PACKING COMPANY,	
Defendant.	

The plaintiff and Messrs. Langhorne & Miller, his attorneys, will please take notice that upon the trial of the above entitled cause the defendant will prove in accordance with the Statute of the United States in such cases made and provided, that the patentee, J. W. Cassidy, to whom the letters patent on which this suit is based were granted, and which are set out in plaintiff's declaration herein filed was not the first and original, or any inventor of the invention and discovery described in and claimed by the said letters patent, but that the said invention and discovery was in fact invented and discovered by and the same principle was known to and had previously been combined by others, and was described in the following United States letters patents, which were respectively granted to the following named persons at the following named dates, to-wit:

Letters Patent Numbered 137,459, dated April 1, 1873, and granted to Alexander Mackey for a "Sugar Drier."

Letters Patent Numbered 156,849, bearing date November 17, 1874, and granted to Harrison & Savery for a "Drying Apparatus."

Letters Patent Number 94,967, bearing date September 21, 1869, and granted to Oscar F. Mayhew for "Grain Driers."

9 Letters Patent No. 115,833, bearing date June 13, 1871, and granted to Thomas W. Eaton for a "Grain Drier."

Letters Patent No. 107,417, bearing date September 13, 1870, and granted to Marshall P. Smith for a "drier."

Letters Patent No. 155,286, bearing date September 22, 1874, and granted to J. O. Button for an "Improvement in Fruit Driers."

Letters Patent No. 29,390, bearing date July 31, 1860, and granted to A. C. Lewis, for an "Improvement in "Fruit Drying Apparatus."

Letters Patent No. 179,275, bearing date June 27th, 1876, and granted to Samuel W. Craven for a "Drying House."

Letters Patent No. 124,944, bearing date March 26th, 1872, and granted to Elisha Foote and M. P. Smith for a "Drier."

Letters Patent No. 48,733, bearing date July 11th, 1865, and granted to Adam Snyder for a "Fruit Dryer."

Letters Patent No. 108,289, and granted to Joseph B. Okey, assignor of one-half to F. A. Lehr, for an "Improvement in Fruit

Driers" dated October 11th, 1870.

Letters Patent No. 134,528, bearing date Jan. 7th, 1873, and granted to Alfred Edwards for "Fruit Driers."

Letters Patent No. 138,516, bearing date May 6th, 1873, and granted to G. R. Nebinger for "Fruit Driers."

Letters Patent No. 133,060, bearing date November 12th, 1872, and granted to B. L. Ryder for an "Improved Fruit Drier."

Letters Patent No. 137,634, bearing date April 8th, 1873, and granted to John Stevenson, for an "Improved Fruit Drier."

Letters Patent No. 143,949, bearing date October 21st, 1873, and granted to John Williams for an "Improved Apparatus for Drying Fruit."

Letters Patent No. 147,860, bearing date February 24th, 1874, and granted to F. S. Packard for "Fruit Dryers."

Letters Patent No. 160,587, dated March 9th, 1875, and granted to Levi A. Gould for an "Improved Fruit Drier."

Letters Patent No. 158,499, bearing date January 5th, 1875, and granted to Edgar A. Jones and Charles W. Jones for "Fruit Driers."

Letters Patent No. 171,202, bearing date December 14th, 1875, and granted to Lee Whittlesey for "Fruit Driers."

Letters Patent No. 160,860, bearing date March 16th, 1875, and granted to J. J. Adgate for a Lifting Jack.

Dated, October 26th, 1891.

WHEATON, KALLOCH & KIERCE,

*Attorneys for Defendant.*

Service of the foregoing notice of special matter admitted by copy this 26th day of October, 1891.

LANGHORNE & MILLER,

*Attorneys for Plaintiff.*

(Endorsed:) Filed October 26th, 1891.

L. S. B. SAWYER, *Clerk.*

11

*Verdict.*

U. S. Circuit Court, Northern District of California.

JOHN W. CASSIDY,

*v.*

HUNT BROTHERS FRUIT' PACK-  
ING COMPANY.

} No. 11,361.

We the jury find in favor of the plaintiff and assess the damages at the sum of thirteen hundred and fifty dollars (\$1,350.00).

JACOB BACON,

*Foreman.*

(Endorsed:) Verdict, Filed December 29, 1891.

L. S. B. SAWYER, *Clerk.*

*Judgment.*

In the Circuit Court of the United States, Ninth Judicial Circuit,  
Northern District of California.

JOHN W. CASSIDY,

vs.

HUNT BROTHERS' FRUIT PACK-  
ING COMPANY.

} No. 11,361.

This cause having come on regularly for trial on the 18th day of December, 1891, being a day in the November, 1891, term of said Court, before the Court and a jury of twelve men, duly impaneled, J. H. Miller, Esq., appearing on behalf of the plaintiff, and M. A. Wheaton and F. J. Kierce, Esqs., appearing on behalf of the defendant, and the Court having on the 22d day of December excused one of the jurors from further attendance in the cause, and counsel having stipulated that the trial of the cause proceed before the Court and eleven jurors, and the trial having been proceeded with before the Court and eleven jurors, on the 22d, 23d, and 24th days of December, in said year and term, and the Court having on the 24th day of said December excused another of the jurors from further attendance in the cause, and counsel having stipulated that the trial of the cause proceed before the Court and ten jurors, and the trial before the Court and ten jurors having been proceeded with on said 24th day of December and the 29th day of December in said year and term, and the evidence, oral and documentary, on behalf of the respective parties, having been introduced, and the evidence having been closed, and the cause, after arguments of counsel, and the instructions of the Court having been submitted to the jury, and the jury having subsequently rendered the following verdict:—"We, the jury find in favor of the plaintiff and assess the damages at the sum of thirteen hundred and fifty dollars (\$1350.00)," and the Court having ordered that judgment be entered herein, in accordance with said verdict, and for costs.

Now therefore, by virtue of the law, and by reason of the premises aforesaid, it is considered by the Court, that John W. Cassidy, plaintiff, do have and recover of and from Hunt Brothers' Fruit Packing Company, defendant, the sum of thirteen hundred and fifty dollars (\$1,350.) damages, together with his costs in this behalf expended, taxed at \$90.30.

Judgment entered December 29, 1891.

L. S. B. SAWYER, *Clerk.*

I hereby certify that the foregoing is a full, true and correct copy of an original judgment entered in the above entitled cause.

Attest my hand and the seal of said Circuit Court this 29th day of December, A. D., 1891.

[SEAL.]

L. S. B. SAWYER, *Clerk.*

(Endorsed:) Filed December 29, 1891. L. S. B. Sawyer, Clerk.

14. *Certificate to Judgment Roll.*

In the Circuit Court of the United States, Ninth Judicial Circuit, in and for the Northern District of California.

JOHN W. CASSIDY,	}	No. 11,361.
<i>vs.</i>		
HUNT BROTHERS' FRUIT PACK- ING COMPANY.		

I, L. S. B. Sawyer, Clerk of the Circuit Court of the United States for the Ninth Judicial Circuit, Northern District of California, do hereby certify that the foregoing papers hereto annexed constitute the judgment roll in the above entitled action.

Attest my hand and the seal of said Circuit Court, this 29th day of December, 1891.

[SEAL.]

L. S. B. SAWYER, *Clerk,*

By W. B. BEAIZLEY, *Deputy Clerk.*

(Endorsed:) Judgment Roll, filed December 29, 1891.

L. S. B. SAWYER, *Clerk.*

By W. B. BEAIZLEY, *Deputy Clerk.*

15. *Bill of Exceptions.*

In the United States Circuit Court, Northern District of California.

J. W. CASSIDY,	}	No. 11,361.
Plaintiff,		
<i>vs.</i>	}	
HUNT BROTHERS' FRUIT PACK-		
ING COMPANY (a corporation), Defendant.		

This was an action at law brought to recover damages for an alleged infringement of United States Letters Patent Number 172,608, bearing date January 25th, 1876, and granted to John W. Cassidy for an alleged improvement in a drying apparatus.

The case came on regularly for trial on the 18th day of December, 1891, before Hon. T. P. Hawley, acting as Circuit Judge, Messrs. Langhorne & Miller appearing as counsel for plaintiff, and Messrs. Wheaton, Kalloch & Kierce appearing as counsel for defendant.

A jury was duly impaneled, and thereupon the following proceedings were had and testimony taken.

(It appearing before any witness was sworn that George W. Beaver, one of the jurors impaneled in the case, was sick and unable to attend the trial of the cause, the respective counsel thereupon stipulated that the case might be tried with eleven jurors.)

John W. Cassidy, the plaintiff, called on his own behalf, was sworn, and testified as follows:

MR. MILLER. Q. What is your age?

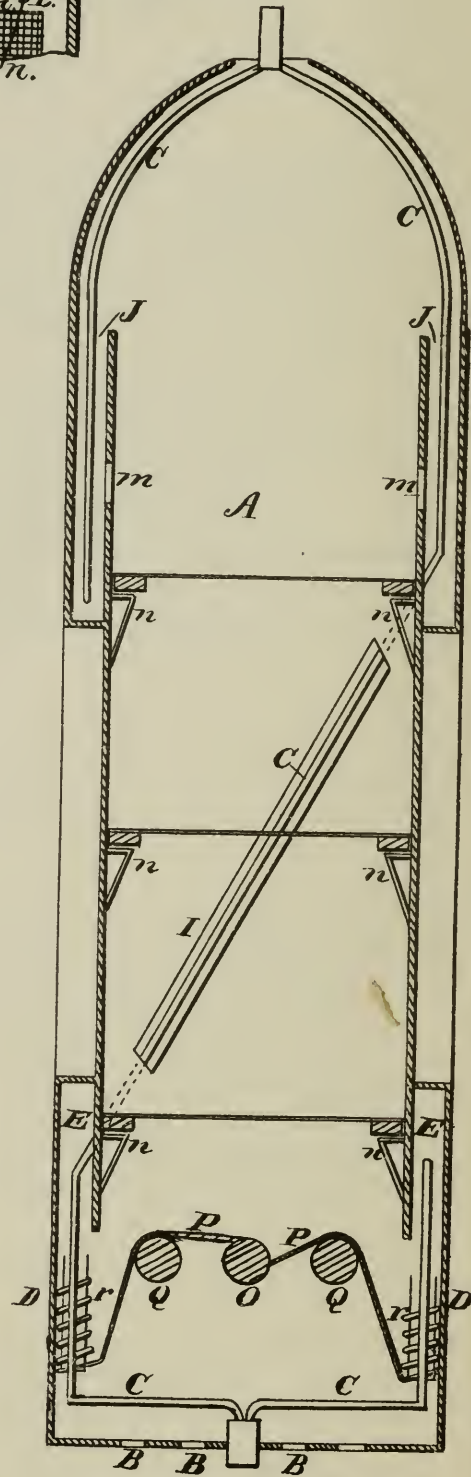
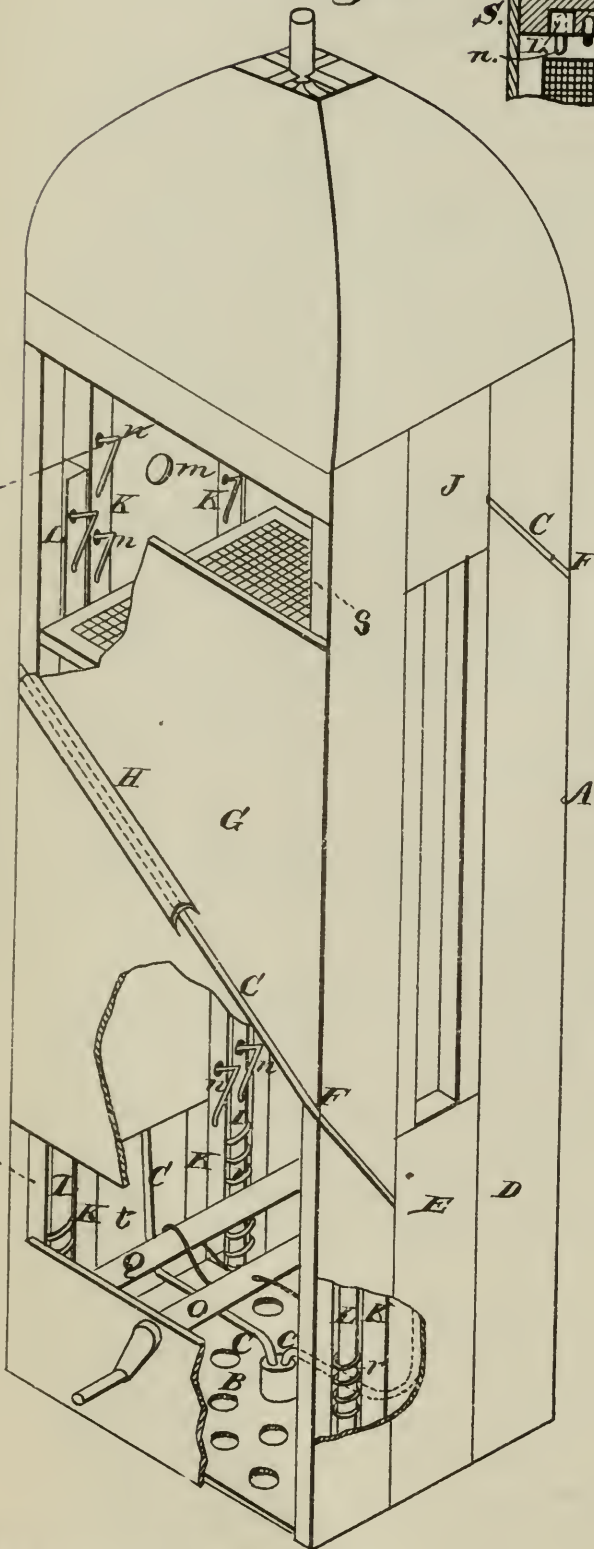
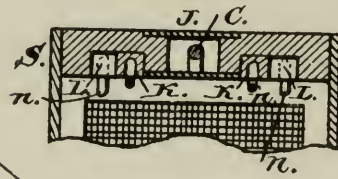



Fig. 1.

Fig. 3.

Fig. 2.



Witnesses  
 Geo. H. Strong  
 J. L. Brown

Inventor  
 John. W. Cassidy

A. 69. I have lived in Petaluma since 1858. I came to  
 16 California in 1852. I came from Wayne County, New York,  
 to California. There was no fruit drying at that time in  
 Wayne County except by the sun. In Petaluma I have princi-  
 pally been engaged in raising, drying and curing fruit. My first  
 drying machine was made, I think, in 1867. I put up a drying  
 chamber and operated it several years. The next drier I put up  
 was like the one shown in the patent sued upon in this case. I put  
 that up about the first of May, 1874. It stood some three or four  
 weeks and was then accidentally burned down. I am the John  
 W. Cassidy mentioned in the patent sued upon in this case.

(The patent sued upon was here introduced in evidence, marked  
 Plaintiff's Exhibit 1, and the following is a thereof, to-wit:

UNITED STATES PATENT OFFICE.

John W. Cassidy, of Petaluma, California.

*Improvement in Drying Apparatus.*

Specification forming part of Letters Patent No. 172,608, dated  
 January 25, 1876.

Application filed March 8, 1875.

*To all whom it may concern:*

Be it known that I, John W. Cassidy, of Petaluma, Sonoma  
 County, State of California, have invented a Drying Apparatus; and  
 I do hereby declare the following description and accompanying  
 drawings are sufficient to enable any person skilled in the art or  
 science to which it most nearly appertains, to make and use my  
 said invention without further invention or experiment.

My invention relates to an improved device for desiccating fruit  
 and other substances by means of artificial heat; and it consists,  
 first, in a novel method of utilizing the heat which passes through  
 the flues from the furnace, and by leading these flues around the  
 chamber within suitable pipes or cases, and making certain open-  
 ings from these cases into the chamber, I am enabled to admit  
 heated air from any or all sides, and at different heights between  
 the layers of fruit, while heat is also admitted from the bottom of  
 the chamber, or not, as may be desired.

My invention also consists in a novel means of moving the fruit  
 within the chamber, from the time it is admitted until it is again  
 removed.

Referring to the accompanying drawings for a more complete  
 explanation of my invention, Figure 1 is a perspective view of my  
 invention, with a portion of the chamber broken away. Fig. 2 is  
 a vertical section in elevation.

A is the chamber of a drier, and it is made of considerable height,  
 so that the fruit can be admitted from below and moved upward to  
 the place of removal from the chamber. The furnace or heater is  
 placed below the chamber, and the heated air is admitted through  
 openings made in the bottom of the chamber, as shown at B, if

desired, but the principal part of the heat, the smoke, and gases of combustion are conveyed away from the furnace by means of flues C, which necessarily carry off considerable heat. This heat is ordinarily lost, but I utilize it, and, at the same time, use it at points where it will be of more value than at present, by introducing it at various points around the chamber, and horizontally between the trays. In order to do this I carry the flues C over the bottom plate of the chamber from the center to opposite sides D, where they pass upward a short distance within inclosing-cases, as shown at E, and these cases, opening toward the interior of the chamber, will direct the heat of the flues into it up to the point where they turn, and are carried diagonally across their respective sides E to the corners, as shown at F. From the corner the flues are again carried diagonally across the two remaining fronts G, and in opposite directions. The flues are also inclosed in cases H on these two sides, and slots I are cut from the cases, so as to open into the chamber and admit another portion of the heated air between the layers of fruit at different heights. After crossing the faces G, the flues are again bent so as to cross the sides D diagonally until they reach the center, when they are carried into the vertical cases J which extend to the top of the drier. Openings *m* are made from the cases J, and thus another portion of heat is admitted to the chamber near the top, to finish the operation. From this point the flues may be carried up along the dome to a central discharge opening or chimney.

Various equivalent methods of leading the flues and utilizing their heat may be employed and will readily suggest themselves, but I have found the present arrangement the simplest and most economical, and I am thus enabled to introduce heat at the right angles with the travel of the fruit, and at any point.

In order to elevate and support the trays of fruit after they are introduced, I have employed a combination of movable and stationary standards upon two opposite sides of the chamber, and these standards are provided with spring catches, which can be forced inward to allow a tray to pass up, but will return to their place after it passes and prevent its going down.

Four stationary standards, K K, are set into the sides of the chamber, and extend vertically from top to bottom near the corners. The other four, L L, can be moved up and down in slots, and stand by the side of the standards K. Each set of standards is provided with spring-catches or supports which are formed as shown at *n* and *n'*, so that a tray moving upward will depress them into the posts, but they will spring out after it passes.

The operation will then be as follows: A tray full of fruit being introduced through the lower door *t* will rest upon four pins projecting from the movable standards or posts. These posts being then elevated, by means hereinafter described, the tray will be carried

up until it passes the first set of catches  $n$ , upon the posts  $K$ . The posts  $L$  are then allowed to descend, and will leave the tray resting upon these catches. As the posts  $L$  descend, four similar catches,  $n'$ , upon them will be depressed and pass below the tray, so that when they are again elevated these last catches will lift the tray above the next set upon the stationary posts, and, in this manner, the trays are gradually moved from the bottom to the top of the chamber, where they are removed by the door  $s$ . Catches which would fall out by gravitation might be substituted for the springs, in some cases. The movable posts  $L$  may be elevated and depressed in many ways, as by cams, eccentrics, &c., but in the present case I have employed a central roller,  $O$ , with a crank at one end. Upon this roller cords or chains  $P$  are coiled, and their opposite ends, after passing over friction-rollers  $Q Q$ , are secured to the lower ends of the posts  $L$ . By turning the crank, the chains will be coiled upon the roller  $o$ , and the posts lifted, simultaneously. If necessary, spiral or other springs  $r$  may be employed to cause the posts to descend, but in the full-sized machine the weight will be sufficient.

Having thus described my invention, what I claim as new, and desire to secure by Letters Patent, is—

1. In combination with a drying-chamber, the pipes or flues  $C$  passing diagonally along the slotted openings  $I$ , around and outside of the drier, and provided with coverings  $E H J$ , substantially as and for the purpose set forth.

In combination with a drier, the stationary posts  $K$ , provided with spring-catches  $n n$ , and the vertically moving posts  $L$ , provided with the spring-catches  $n' n'$ , and suitable mechanism for operating the posts  $L$ , substantially as and for the purpose set forth.

In witness whereof I hereunto set my hand and seal.

[SEAL.]

JOHN W. CASSIDY.

Witnesses:

GEO. H. STRONG,

JNO. L. BOONE.

17 MR. MILLER. Q. What is this model that I now present to you?

A. It is the same as my patent. It was made by a man named Keyes. I am familiar with the second claim of this patent. There are devices in that model to represent that claim.

Q. Please take this patent and this model together and explain to the jury that device so as to show them how it operates?

A. In the first place, get down to the mechanism—have got to have something that is handy, and after trying several I found this the most convenient to raise my trays, from the fact that my trays have all got to act uniform. If they should clamp in there the trays would not go up right, and I used this here, and a bevel here, and you can adjust it so that every tray and every spring

comes exactly right at the proper time. In order to raise my fruit I use what they call a movable post. I put in catches in order to hold the trays, and by so doing it brings the spring up in the stationary posts. That spring will hold the tray when I reverse that and the movable standard goes down, and by that means I can fill up the tray from the bottom to the top. It is much better to have your greatest heat on the greenest fruit, and leave it in five or ten minutes until it is partially dried, and by turning this that way, we raise that up step by step, and it is all kept separately, so that any time you can take out fruit at any place you want to. Sometimes fruit gets dried and you want to take it out here, and some-run it to the top. In order to hold that you have these stationary catches here.

18 A Juror. Q. In order to get that in you turn those posts back?

A. Yes—posts or slides all the same thing. By raising that up again it passes the catches. They all set uniform all around, and by reversing it, it brings it down again. That is ready for another layer of fruit. The green fruit is put into the drier at the bottom and taken out at the top. The object of having this moving of the fruit inside of the drier is in order to get at the heat at the most available points. If you should put this in by hand it would require a great deal of extra labor. Sometimes if the fruit dried here or there, or *vice versa*, and taking it out by hand, it would require a great deal of time and also loss of heat, and for that reason I have that thing against the boards, so as to leave the chamber entirely closed. I insert the tray and close that down immediately, and when it comes up to the top, instead of opening the whole side, take it out here, and that retains the heat; whereas if I took it out by hand I would have to leave the whole side open, and leave it open perhaps fifteen minutes at a time in order to adjust those trays up and down.

A Juror. Q. You do not make any claim for that table do you?

A. No sir. My claim is simply on the slides and posts.

The degree of temperature generally used in these driers for drying fruit, is about 200. I have caused ten or fifteen driers of this kind to be built in Petaluma, at the machine shops of Cam and Rod. Some of them were used in Ventura county, some in Monterey, two in Santa Cruz, three in Sonoma. I think there are sixteen or seventeen in Ventura county, that is I did not build all of them, but I built some of them.

19 In size they were three feet and a half, the trays, and the trays run from twenty to thirty in a drier, according to the size that the party wanted them. I have used these driers myself, have examined their mode of operation, and noticed the success with which they operated. That success has been good.

With these driers I have dried prunes, plums, peaches, apricots, pears, apples—in fact, all kinds of fruit that is dried by the sun or artificial. This year I dried a small quantity. Last year in my factory at home and in Sonoma I dried some ten or fifteen tons, after they were dried. I have three driers at Sonoma, made according to my patent, and one at Petaluma. Those at Sonoma have been run two years, including this year, and the one at home for ten or twelve years. This same drier has been running ten or twelve years, excepting this movable post—this standard here—I replaced them, otherwise the drier is just as good as twelve years ago. The movable posts got worn out, that was the first repairs that I made on it for over ten years. I think Mr. Tupper did the mechanical work upon that drier.

The selling price for these driers that I have made or caused to be made has been two hundred and fifty dollars. The cost of manufacturing them has been about \$125.00.

I know the Hunt Brothers Fruit Packing Company of Santa Rosa. I have known the three Hunts who are connected with that firm—the father and two sons who are present in the Court-room—for some ten or twelve years. I have been in their establishment at Santa Rosa where they dry fruit. I have seen 18 driers there in operation. That was in July a year ago, I think, the first time I saw them.

20 Q. Describe the devices they had for raising the trays?

A. I think this model is as near exact as it can be. The trays are held up by catches and fall out by gravity, or gravitation catches, so that each time you move that up it takes the tray precisely as it does this—just moves it one step. The frame-work is down at the bottom, and set the tray there, and I want to move that one step, and now I want to move this one step, just the same as that (illustrating). Now I put another one in, and the same device of putting the tray in the bottom while the fruit is green and fresh, and move it gradually to the top, and when they get to the top, if the heat was all right, the fruit was sufficiently dried to take the fruit and put in a pile, and then that tray would be emptied and taken out and put in the bottom. You see that is the sliding post the same as that. You see it is a stationary post the same as that. You see they have a set of posts at each corner, precisely as that. I use my finger on the mechanism, because I have no claim on the patent about raising these up at all—do not make any claim.

A Juror. Q. What contrivances do Hunt Brothers use for raising the trays?

A. They have a lever. I suppose the fulcrum is about here, a cross piece, and I suppose the mechanism throws it up. In that respect they use a lever instead of a crank.

I never had any conversation with any of the Hunt Brothers

about their infringing my patent. I spoke to Mr. Hunt, the old gentleman, when he first commenced building his drying factory, some eight years ago. He was excavating ground and said he was going to put up a drying factory. I asked him what kind of a machine he was going to put up, and he said he was going to put up one better than mine. I told him it would be better to buy of me. He said no, he would build a better drier.

21. He said, "I don't know but what I shall have to use some of your devices." I said, "You are at liberty to use any device I have, provided you don't infringe on me." He said, "I ain't going to infringe on you." I said, "Go ahead, but if you do, perhaps there will be some trouble." I don't know that I had anything to say to him afterwards about it.

I don't know that he saw any of my driers prior to that time. He built them at Green Valley, Sonoma county. I am positive I saw five there. I don't know how many he built at that time, because I don't know that I went there again until this year. I caused notice to be served upon them before this suit in regard to the infringement.

From my fourteenth year I was always in mechanism. The first was building agricultural machinery, part of the time I was building woolen machinery and pattern making and setting up and operating machinery. I worked with my father a good many years. He was a mechanic, and I presume you might call it serving my time. I worked as a mechanic in New York. Since coming to California I worked in the Golden State Miners' Foundry, and also in the Vulcan. In my judgment the gravity catches used by the defendant are precisely the same as the spring catches. They accomplish the same work. A spring would naturally work on the same principle as a gravity catch for holding the trays and moving them from step to step. I have always known of springs being the mechanical equivalents of weights in mechanics. That is generally conceded by mechanics.

Q. Look at this small model and state what that is?

A. That is what we would call a gravity catch — falling out by gravitation. The heaviest part stands out from a perpendicular  
22 line, and as the body passes it, it falls there until it gets over, and then it falls out. That is weight. Here is another one. That is a spring where it requires weight in order to bring that out. That accomplishes the same thing, and those movable posts in here, Hunt or mine, neither one could get that fruit up, unless it was on movable posts—the sliding standard. That gravity catch in the model represents the devices of the defendant. I got it at the Santa Rosa foundry. I don't know who made the driers for Hunt Brothers.

The first device I got up for elevating trays when I commenced this business was the gravity catch. That was about the 1st of



May, 1874. I then dried fruit with it. That is the first idea I had, and that had gravity catches.

Q. When was it that you put in spring catches?

A. In 1875, the next year—those three first I built. The first one I built was the same as that with the exception of this gravity catch. I had springs in that, but I made gravity catch in that. The two next I built in the same factory I used only just four springs, and in putting in my tray that would bend it up over a spring or a catch, and would hold it there, and the next springs have lugs on the corners four inches high, and take the next above it, so that when that chamber was full it was like a pile of bricks—could not move either one of them unless you got them from the top.

Q. What have you done towards introducing or developing your patent since you obtained it?

A. I have sent out about 15,000 circulars all over the United States, took pains to get the postoffice addresses, sent them to postmasters and got them to distribute them as far as I could to individuals. I have had two agents in New York working, one in Wayne county, and one in Erie county and an agent in Oregon.

I don't know whether I had any more or not.

23 I know of three or four driers made according to my invention being used in Ventura county. I have been informed that there are a good many in Santa Clara county. My two or three agents back there several years ago said there was so many infringements used that they could not do anything; had to abandon the field on account of so many infringements, the same as this.

The reason I have not prosecuted infringers of my patent is because I was advised by an attorney that it would be better for me to let it go until the expiration or near the expiration of the patent, and then commence suit. That is one of the reasons, perhaps the greatest reason, and for the last three or four years I have not been pressing the matter much. Suits have been brought in my name in New York on this patent. That suit is not decided yet.

I have had all facilities to put up those driers as fast as people required them—machine shops and foundries and planing mills and everything else and good mechanics.

I have been paid royalties for those driers in New York.

The trays of the driers I saw in Hunt Brothers Fruit Packing Company, were three and a half feet square. I think there was a material difference in the cost of manufacturing his and mine. Mine, including the furnace and all, amounts to about \$125. Without the furnace it would be about \$25.00 less.

One reason why I have not collected royalties on these driers in California, is because the attorneys' fees were too much. I had not the money to fight the suit—commence suit. That was the greatest reason I did not commence several years ago. I came down

24 and consulted<sup>1</sup> some lawyers with the express purpose of suing a party down in Ventura county—I think about six years ago—and the attorney I went to see wanted \$1000.00, and I had not it and therefore had to stop. I have not collected royalties from people in California for infringing my drier for want of means to prosecute the case.

MR. MILLER. Q. Mr. Cassidy have you fixed a royalty on your driers?

A. Yes sir.

Q. What royalty?

A. A hundred dollars.

Q. Have you received any royalties on them before?

A. I have.

Q. Where have you received them?

A. In the State of New York.

Q. More than one?

A. Yes sir.

*Cross Examination.*

MR. WHEATON. Q. In the instances where you have received a royalty in New York, had they already infringed on your patent?

A. No sir, not to my knowledge. Two parties in New York paid me \$100. apiece for the privilege of erecting driers that would contain my patented device. Nobody in this country had directly paid me a royalty; only giving me the profit on a machine, \$250. I had an agreement with a man who went to Oregon named Beard. He was to pay me \$100 a machine. He did not pay me anything. He built some. The parties who paid me \$100. royalty in New York wrote to me that they wished to build machines. In the letter they made me the offer, both of them. I accepted and sent each of them a power of attorney to go to work. They offered to pay me \$100. on a three and a half foot machine.

25 Q. Did they at the same time wish to become your agents in selling those machines?

A. Simply the fact that they were paying me that amount of royalty, and manufacturing machines for certain territories. They worked in the territory in building machines.

Q. Let me see if I understand that right? These parties were acting as your agents and agreed to pay you \$100. royalty for all the machines they would build, is that it?

A. They were building machines and paying me royalty in specified territory; for instance, one man has Wayne county; he built me the machines and sold them and sent me the royalty; another man in Erie county, he built machines and did the same thing. They were building machines under a license from me and the agreement was that each machine they built they would send me \$100. We divided the rental between the man and myself, so that really I got fifty dollars and he got fifty dollars.

Q. How many machines did you get \$100. on yourself?

A. I qualified that just now in my last answer. The royalty was \$100., but he was working for me, and we divided it. I got \$50.00 and he got \$50.00. I could not state on how many machines I did actually get \$50. royalty. It is a good many years ago and my correspondence with him is all destroyed.

Q. Are you sure that either one of those men ever sent you \$50 for a single machine?

A. Yes sir, I am positive of it.

Q. Which one of those men was it?

A. In Wayne county. He sent me several hundred dollars. That shows that they built quite a good many. I don't remember the amount. It was \$200 or \$300. May be a little more.

Q. In this country no one has paid you royalty on a single machine, for the privilege of building it?

26. A. No sir, not here; my contract was with Beard who went to Oregon. He was to pay me \$100 a machine. He wanted to build machines. I made that contract with him and gave him a power of attorney to go on and build machines under that stipulation. He was to send me \$100 on each machine. That must be about ten years ago. I cannot get at the exact date or the exact year. My mind has never been called to it till just now.

The first fruit drying machine where the trays of fruit were put in at the bottom and carried gradually to the top, one above another, was the Alden machine. I saw that in 1874 or 1875, somewhere about that time.

Q. What is the difference in operation between that machine and yours?

A. I think I can explain this thing with this model, Plaintiff's Exhibit No. 2. I suppose you all know what an endless chain' is. It is formed by links, and these flat links are fetched together and run over pulleys or sprocket wheels as this endless chain comes up. They are far enough apart to keep the trays separate. There would be an arm to each one of those links. As it comes up on the sprocket wheel they would be four square or six square or eight square wide, enough to accomodate the link. The sprocket wheel is where the endless chain runs over at the top and one corresponding at the bottom. As these links comes up there is a projection on the link that comes through perhaps a couple of inches, to receive the tray as you insert it. As you put that in with mechanism, those chains all move together. There is a chain on each one, so that when you apply the mechanism, each chain moves in unison. As the next link comes around, you put in another tray and continue until it is full.

27. A JUROR. Q. These arms of the chain would project out?

A. Yes sir, and that would hold the tray until it got to the top, and the tray then would be removed before it struck the

sprocket wheel. When it struck the sprocket wheel one portion of the chain would be going down outside while another portion would be coming up inside. That is the way the Alden machine is operated.

MR. WHEATON. Q. So far as drying the fruit is concerned, and the movement of the tray is upwards, what is the difference between the Alden machine and your machine?

A. It would be the same. I will not say the movement of drying would be the same. The movement is different.

Q. I speak of the movement of the tray alone. Would they not move up the same in one case as in another, provided the machine was worked at the same rate of speed and same intervals of time?

A. Yes sir.

Q. The trays would be carried up just the same in one machine as they could in another?

A. Yes, sir.

Q. In neither case are the trays constantly moved up, but are carried up step by step, and allowed to remain there until the fruit is dried a while, and the bottom one taken out, refilled, and put in at the bottom and carried up another step until the next one is sufficiently dried to remove?

A. Yes, sir. Between the times of movement of the machine to carry a tray up one step from fifteen minutes to half an hour intervene, owing to the variety of fruit and the amount of heat.

Q. Are the furnaces in the Alden machine capable of being arranged as in your machine?

28 A. I don't know; the furnace certainly is at the bottom, but what kind of a furnace they use I don't know.

Q. What other drying machine of this stack, or cappillary kind, is there that you know of?

A. That is the only one I ever saw outside of mine, at that time. I have since seen them with those gravitating catches, but not before. The Alden machine is the only machine that I saw outside of mine.

Q. Would you not understand that your invention was to substitute this kind of movable posts and these catches for the endless chain of Alden for the purpose of carrying up those fruit trays?

A. I did not so intend it. I intended to carry up my fruit trays by those springs, without any regard to what Alden or any one else did.

Q. Did you make any other change at that time that you can think of in fruit trays, so far as the second claim of your patent is concerned, other than to substitute this kind of catches and posts for the endless chain with the arms on, which are used in the Alden drier?

A. I have no recollection of ever having made any change from what you see here.

Q. What change did your invention make in fruit driers?

A. It had a tendency of rather revolutionizing the fruit drying business, for immediately after I got my patent most every one was using these devices East. They were using my catches and sliding posts. The Alden had the name of being a well known and celebrated fruit dryer. My dryer would dry the same as the Alden.

I don't suppose it would dry any different kind of fruit. I don't think it would dry it in any different manner.

29

*Re-direct Examination.*

MR. MILLER. Q. You stated in your direct examination that the Hunt Brothers Fruit Packing Company had eighteen dryers?

A. I did. Twelve were in one house and six were in another, probably twenty rods apart.

Q. Had your invention any advantage over the Alden dryer?

A. It had very much. As I was showing you before, this endless chain in order to reach a couple of stories, perhaps ten or fifteen feet each, would be thirty feet long, and enough at the end to cover those sprocket wheels. The cost of them is quite material, much more so than the cost of mine. Sometimes the endless chain breaks. If it breaks, the whole thing from the top to the bottom is dumped down on the furnace while if one of these springs or catches should get out of place it does not materially hurt the working of the machine at all, because nothing goes down. The catch below will hold and sustain it above and still raise it. While this being comparatively cheap, the Alden is very expensive. In the Alden drier half of the chain is inside and the other half outside. In order to make it revolve over the top, as it comes down on the outside, it ascends on the inside. That gathers up the fruit and takes it to the top. The number of apertures necessary to be made in a drying chamber in order to operate an endless chain machine like the Alden would depend considerably on the height of the machine required. The machines they used were about ten to twelve feet, or a little more. A portion of the chain was outside and the other portion inside the chamber.

30 Q. Where was the hole or aperture cut in the chamber for the chain to enter?

A. As it entered inside it rolled over the sprocket wheels, coming down to the bottom, it cuts a hole in the bottom. Whatever the width of the chain is it has to have that space at the bottom in order to bring the chain through. It also has a space cut at the top; it came through the top on the same principle. Those chains were three or four inches wide as near as I can remember.

Q. So that this chain was revolving continually, half of it on the outside cold atmosphere, and the other half on the inside hot atmosphere?

A. Yes, sir. If one of my catches should break it would just

simply let the tray hang on to these springs and would move up on a little angle. The drying capacity need not stop. If it was necessary to put one of my catches in, it could be done in five minutes without reducing the heat a particle and work right along.

Q. What would be the comparative cost between a drying chamber made after your patent and one after the Alden patent?

MR. WHEATON. Q. Did you ever make any of the Alden fruit dryers?

A. No, sir.

Q. Do you know what they cost, speaking now from actual knowledge.

A. No, sir; not from actual knowledge. I could approximate it.

Q. Do you know what the chains suitable for working in the Alden Chamber cost per foot or per pound?

A. I think some eight or ten cents per pound, perhaps more. I would not state anything about that because I don't know.

MR. MILLER. Q. You are a mechanic?

31 A. Yes, sir. I have been for a number of years engaged in mechanical pursuits. I have seen a great many driers of different kinds. I think my knowledge of mechanics is sufficient for me to give an intelligent opinion as to the cost of a piece of machinery when I see it.

Q. With that as a basis I will repeat the question and will ask you which in your judgment, would be the cheapest to construct, yours or the Alden?

MR. WHEATON. I object because the witness says he does not know what the Alden drier would cost.

THE COURT. I will allow the testimony.

*First Exception.*

To which said ruling of the Court the counsel for the defendant then and there duly excepted and hereby tenders this its bill of exceptions to the Court to sign and seal and the Court does hereby sign and seal the same.

A. I think so far as the shifting apparatus is concerned this would probably be fifty per cent cheaper than the Alden, fifty or seventy-five.

MR. MILLER. Q. Did you ever see any Alden driers in operation?

A. I saw five at San Lorenzo in 1874. They are not used in California now, to my knowledge. I think they went out of use about 1875. I have not seen them in use on this Coast since that year. I have seen about all the fruit driers operated in California during the last ten or fifteen years; not all, but I have seen a good many. A man named Pile had charge of the Alden Drier when they were in use in California. He went East in 1875. I

32 have not heard where he is since. He saw my style of drier before he went East. He examined my drawings, not the machine.

At several periods in the life of my patent I have endeavored to have some attorney take hold and help me out, even on a salary or on a contingent. An attorney would not bring suit because I had not money and could not get it. I tried to have it taken by three different parties in the city on a contingent fee, but neither one would do it. Their prices were so high that I could not reach it, therefore I went back home and plodded away on my fruit orchard. A thousand dollars as a retainer was the cheapest price they asked.

MR. WHEATON. Q. When did you examine the defendant's driers?

A. Last year, I cannot state the month. I was up there and sold them my cherries, and stayed around the building. That was the first intimation I had of there being machinery there. It might have been July, or earlier or later. I don't know that any one showed me around the defendant's works at that time. W. C. Hunt showed me around his canning factory. He did not show me around the driers. The building was full of operators, preparing and drying fruit and taking it out. The carpenters were at work when I was there with the cherries, in both buildings. That was in 1890, a year ago last summer. The defendants were drying fruit when I saw them.

Q. Have you been there since you were selling cherries in 1890?

A. I was there when I went up to consult the defendants in regard to some discrepancies in a settlement. That was the time I saw those fruit driers. I arranged all my business in the office about the cherries, and afterwards went into the drying factory, and did not see either of the defendants there.

33 Q. At that time, after examining this drier, did you hint or intimate to them, that they were infringing your patent?

A. I did not see them to my knowledge at that time.

Q. Who did you reconcile the discrepancies with, in the settlement that you speak of?

A. What I mean to say is, I did not see either one of those gentlemen in the drying factory. I had arranged all of my business in the office about the cherries. Afterwards I went into the drying factory. I have no knowledge whatever of either one of those gentlemen being with me.

Q. You sold your cherries to the defendant?

A. I did.

Q. Did you deliver those cherries yourself, or send them up on the railroad?

A. I sent them up on the car.

Q. Then there was some discrepancy about the settlement for

the payment of those cherries?

A. In regard to weight.

Q. And you went up to have that adjusted?

A. Yes sir.

Q. To Santa Rosa?

A. Yes sir.

Q. And at that time after you had that matter adjusted, you looked around and saw these driers?

A. I think that was the day. I am not positive.

Q. Whether that was the day or some other, did you, when you saw the driers, and was there on the premises, give the defendants, or either of the Hunt Brothers, or any officer of the company that you saw there, any hint or statement or indication that you considered those driers an infringement on any of your rights?

A. I did not.

34 Q. Why did you not if you thought it was?

A. Because I did not see them. I came away immediately, and did not say anything to them about it. I will state further my curiosity was, because they were drying a great many prunes and I wanted to examine the prunes as I was interested in the drying business. That caused me to go in there. When I came to look at the chamber, thinks I, that is mine. I looked in as they were manipulating two machines, and I saw it was precisely like the machine that I first built.

Q. In drying fruit does not a great deal of the fruit stick to the sides of the drier and machinery in it?

A. Some kinds of fruit does.

Q. Do not the machines often get clogged up from the fact of the partially dried fruit sticking to it?

A. The catch that falls by gravity might very much.

Q. Have you not known a great deal of trouble with your machines, because of one side of the tray sticking, when the catches were lowered, and one side of the tray dropping down so that it would turn up edgewise?

A. Not in my present mode of running. I have seen them when they were running with those gravity catches, where the juice would get in the side and the friction would prevent them from dropping out. The difference between the gravity catches and my catches in that respect is that the spring is strong enough to force it out by itself, even if there is a little wax on it. In that respect there is a difference between the catches that operates by springs and those that operate by gravity. The difference is this: The reason why I substituted the spring instead of this gravity catch was, in drying some kinds of fruit the juice when it gets cooked forms a gummy substance there is not much heft in

35 the catch to carry it out by gravity. A little trifle that gets in there will hold it. You see as I hold it now, a little ver-



tical, it will hold it all day long and will not come out, I found it so with my first machine. With this it will always come out; it does not make a bit of difference. For that reason I used this thing in preference to the gravity catch. There is no friction nor anything to quite stop that spring from coming out. Again, if the spring breaks in the machine, it only costs about a cent and a half apiece, with a little hammer you can drive them back almost inside of a minute. Here is a stop to hold them from falling out, and a stop or a wire through the bottom. Let that get broken or loose, instead of taking an awl and pulling that out and driving it back in order to get this in, it will be necessary to take that whole side out, or to take out all the trays and shut it in this way (illustrating). That was another reason why I substituted this spring instead of that gravity catch, because I had to do it 2 or 3 times in order to adjust the catches there.

MR. WHEATON. Q. In the Alden drier, where the chains were used, were there any chains for the trays to turn edgeways on account of sticking?

A. No sir.

Q. So far as that one particular operation was concerned your spring catches are more like the Alden drier, than are the gravity catches of the defendants, are they not?

A. I don't think so. My catch is quite different from a lug, a lug passes over, or a catch or a finger. That does not come in contact with anything, only just to lift the tray. In the Alden drier there was no such sticking, because they went positively round in one direction over the wheel. There was no chains for one edge of a tray to drop back on the Alden dryer, unless one of those fingers broke off. The Alden dryer would not stick. Nor is there any stopping of those catches in my machine by their sticking.

Q. While in the defendant's gravity catches, you say they do stick, and there is a difficulty there resulting in one edge of the tray dropping down. Is that so?

A. They did in mine, the same kind that Hunt Brothers are now using.

Q. In that one respect, avoiding the dropping back of the trays on account of the catch sticking from the dry juice of the fruit that is dried in it, does your machine operate most like the Alden drier, or most like the defendants'?

A. They all have an upward movement. The defendant's mine, Alden's and Smith's, all have an upward movement. At the same time they have a little different mechanism.

Q. What do you understand by the term "mechanical equivalent?"

A. Performing the same work.

Q. You say that the chains and lugs in the Alden machine so

far as receiving the trays, one at a time, at the bottom and carrying them up and permitting them to be removed, one at a time, from the top, operated the same as the devices used in your machine, that is so, is it?

A. The device in my machine goes up by the catches, step by step. Theirs went up on an even grade.

Q. You stated that the different sets of devices carried the trays up in the same way?

A. They carry them to the top but they do not carry them in the same way with my mechanism.

Q. I understood you to testify that they did.

A. If I did I was a little wrong in that.

37 Q. In what different way does yours carry them, from what the chains and lugs in the Alden machine carries them? If there is any different way?

A. They take theirs by an endless chain. I take mine by a sliding post and a stationary post.

Q. Does that endless chain and those lugs and your sliding post with the catches and lugs carry those trays up in the fruit drier in the same way or not?

A. They carry them up on the endless chain and they reach the top on an endless chain. Mine are taken from the bottom with a sliding post and taken to the top. They all reach the top.

Q. What work does yours do, that the chains and lugs in the Alden machine did not do?

A. Really, I could not tell you.

Q. What work did the chains and lugs of the Alden machine do which the sliding posts and spring catches in your machine does not do?

A. The trays are put in the Alden machine; when the endless chain moves, that moves up. When I put it in my machine there, when I turn my mechanism, they move up. They are calculated to both do very near the same work. They would reach the same end; providing the heat and all is all correct at the top, perhaps the same, but there is a difference in mechanism in getting them there.

Q. Are not the chains and the lugs in the Alden machine the spring catches and sliding posts in your machine, the gravity catches and sliding posts in the defendant's machine all mechanical equivalents of each other?

A. They all reach the same result.

38 Q. Are they all mechanical equivalents of each other, as they have been used in the fruit dryer, for the purpose of receiving the trays of fruit at the bottom of the stack, one at a time, carrying them up, and permitting them to be taken out from the top of the stack, one at a time?

A. They are all received at the bottom the same, and all taken

out at the top the same. I do not think they are mechanical equivalents of each other because they are of different constructions.

Q. The spring catches in yours and the defendants are of different construction, are they not?

A. They are constructed differently, mine is a spring, and theirs is a gravity catch. They are made different, and will all reach the same result.

Q. If your spring catches and sliding posts are in your opinion mechanical equivalents of the different gravity catches and sliding posts, although they are differently constructed, and as you have testified, operate in some respects differently, why are not the chains and lugs of the Alden machine mechanical equivalents, both of the devices which you use, and those which the defendant uses, for the purpose of receiving the trays at the bottom of the dryer, one at a time, carrying them up, and permitting them to be withdrawn from the top, one at a time?

A. I think, that so far as the spring and gravity catches are concerned, they would be equivalents, but I cannot see it on the Alden.

Q. Have not machine chains all sizes been sold at very cheap rates for a great many years at the hardware stores, as a common article of commerce?

A. There is perhaps a certain size chain which comes in use all the time and is sold very cheap. Sometimes chains cost  
39 very much more, where there is no market for them, where they have to be made expressly for a purpose, 7 or 8 times more. When a chain is manufactured by children, as they do their little chains running on sprocket wheels, those chains should be sufficient to carry a ton weight, because the whole rests from top to bottom on that chain. Every tray rests upon a catch. Every catch is separate from the rest. One tray weighs 24 lbs. That tray has four catches to support the 24 pounds weight. That is 6 pounds to each weight. I don't know and could not tell you the weight of a three and a half foot square tray loaded with green fruit, it might go to 30 to 40 pounds and it might go less. With thirty or forty of those trays all resting on that endless chain, if the chain breaks the whole thing tumbles down to the bottom. If one goes all go. There are four catches. Four times six is 24.

There will be 6 pounds to each corner or spring. Whenever they move it will be precisely the same. Every catch has its weight 6 pounds. When they get up here, that is reversed and the weight comes in on the stationary posts. If either one of those springs break, it would just bring the tray down corner ways about four inches, otherwise in the Alden as I said before it would all go from the top to the bottom, which they have done.

I could not tell what was the largest kind of a drier I ever saw carry fruit. Some of them will carry a ton or more. I cannot tell

without a little calculation what mine would ordinarily carry. Three and a half feet square filled with apples will take from 25 to 30 pounds, perhaps a little over. It will be something under 40 pounds. The number of trays is according to the altitude of the drier. A thirty tray drier would be about the extreme length.

Thirty trays of 40 pounds each would make 1200 pounds.  
40 Sometimes any ordinary chain will carry twice 1200 pounds without any danger of breaking, and sometimes if there is a bad link it will break with a good deal less. Chains are not made perfect. I suppose that machine made chains strong enough to carry ten tons have been a common article of merchandise for twenty years past. These are malleable iron chains. I never saw one but what was malleable iron on the sprocket wheels.

JOHN B. TUPPER, called on behalf of plaintiff was sworn and testified as follows:

MR. MILLER. Q. What is your age?

A. 63. I have lived at Petaluma since 1871. I have known Mr. Cassidy the plaintiff for 25 or 30 years. I have seen his fruit driers in operation. The first one I saw had drop catches. That was in Petaluma, I think in 1874 or 1875. I helped to make it. I made the ones he has been using ever since after the first one burned down. I was a machinist then, I worked in a machine shop in Petaluma.

Q. Look at this model Exhibit No. 2, and state whether or not that correctly represents Mr. Cassidy's drier.

A. It is an exact model as nigh after his patent as it can be. I have seen it before. I recognize the device, shown in the model, consisting of the movable and stationary posts and spring catches for elevating the trays. I have seen driers operated on that principle. I have helped build six of them, I think, and have seen them in operation. Every one who used them like them, said they could not be beat.

I do not know the Hunt Brothers. I have been to their  
41 fruit packing factory at Santa Rosa. I think I saw six fruit driers there. I think they were all in the same building. That was two months ago, I guess. They were not in operation. They looked as if they had been used.

Q. Do you remember what kind of a device he had for raising the trays?

A. A kind of an arm came out to take hold. I could not tell what that connected with to operate the trays.

Q. How did the device for operating the trays compare with what is shown in the model, Exhibit No. 3?

A. They looked like the same thing, as nigh as I can see I called those catches the drop catch or gravity catch.

Q. How did the device you saw in the Hunt Brothers' drier compare with this model Exhibit No. 4?

A. That is a good deal like it. All I could see was just sticking out. I worked the... back and forth with my finger. They worked backwards and forwards, the same as this wheel as nigh as I can tell.

WILLIAM KEYS called on behalf of plaintiff was sworn and testified as follows:

MR. MILLER. Q. How old are you?

A. 61. I live in Bodego, Sonoma County. I have been a mechanic about 50 years. I have had nothing to do with fruit driers except building models. I built one for Mr. Cassidy in Petaluma, before the New Orleans Exposition. I have seen the Cassidy driers in operation at his own place in Petaluma, when he came for me to build the first model, that went to New Orleans. I built model Exhibit No. 2, three or four years ago under Mr. 42 Cassidy's instructions. The Hunt Brothers have been pointed out to me to-day. I was at their place at Santa Rosa about two months ago. I saw fruit driers there, I believe twelve, six in each row. The twelve driers were all in one building, under one roof.

Q. What kind of a device did they have for elevating trays in the fruit dryer?

A. This and Exhibit 4 is as like it as it could be made, and this is how I built Cassidy's. The catches and the method of operating them in Exhibit 3, are the same in principle as I saw, in the Hunt Brothers' place, only on a different scale.

L. W. SEELY, called on behalf of plaintiff was sworn and testified as follows:

MR. MILLER. Q. What is your business?

A. Solicitor of patents and expert in patent cases. Have been connected with business before the patent office for about 16 years. My place of business before coming to California, was in Washington city, in the same business, soliciting patents. Reside in San Francisco, about two years, in the same business. The main part of my business has been examining inventions and machines and preparing applications for patents upon them. A knowledge of mechanics and mechanical principles is necessary for a correct practicing of my business. It is necessary in preparing the specifications of patents, for the reason that in preparing applications for patents, we have frequently to work from very crude ideas furnished by inventors themselves, or from very rough sketches which have to be worked into an operative device. In those cases it is necessary to prepare the application from an inspection of the machine itself, either in construction or operation, and that must be understood thoroughly.

43 I have testified as an expert in patent cases several times since I have been in San Francisco, several cases.

I have examined the patent marked Exhibit A, granted to John

W. Cassidy, and I think I understand it. The device described in the second claim of the patent is an apparatus for drying fruit. It consists of a tower or inclosed structure.

This is an inclosed structure or tower having a furnace underneath from which hot air is admitted to the interior. The trays which contain the fruit and which are arranged in series one above the other are placed upon the spring catches which are set in fixed vertical posts inside of the drying chamber and near the corner. In the operation of drying, it is necessary to move the trays of fruit from one part of the chamber to the other, so that they shall be exposed to different degrees of temperature. This is accomplished in this case by the use of a sliding post or sliding standard, having spring catches similar to those in a fixed post. When the tray is put in at the bottom, and this shaft is turned, the sliding post will push the tray up until the edge of the tray snaps over the catches on a fixed post, and will be held at its four corners. This shaft is then turned in the other direction, and the sliding post returns to its former position, the tray being held on catches on a fixed post. This operation being repeated while the fresh trays are being put in below, and those below being carried up to the top each tray being held by the catches on the fixed post. They are then removed from the top. So far as the elements of the second claim are concerned I believe that is all. This model, Exhibit 3, does not contain all the elements of a drying apparatus, it shows the device for lifting trays of fruit. It contains all the elements of the second claim of the patent, the fixed post, the movable post, and the series of catches on each, operating in precisely the same way, as they do in the model here, and having the same relation to one another.

Q. What difference, if any, do you find in the construction of the catches between the two models?

A. I do not find any at all except these are gravity catches, and those are springs. So far as raising fruit trays are concerned I should say their operation is identical.

Q. From your experience as an expert, and from your knowledge of mechanical principles as an expert, I will ask you whether or not a weight is an equivalent of a spring for producing pressure in a certain direction?

A. Yes sir, that is one of the elementary principles, one of the first things that a person engaged in the patent business learns, that a weight, as a general thing, is the equivalent of a spring, where it performs substantially the same purpose as a spring. Take a large clock, like that one in the Court-room. The descent of that weight conveys movement to a train of gear wheels which operates the hands, in a small clock there is not room to put such weight, consequently a spring is substituted acting precisely in the same way, performing the same functions and bringing about exactly the

same result and they are the equivalent. In this case it seems to me they are even more identically the same than they would be in a clock. You press that back. It snaps over the top. You press that up, and it falls back by gravity. Suppose that were to bind, and would not fall back, and it was found necessary to put in a spring to force it down. It would certainly be a spring catch then?

45 Q. I will ask you whether or not in your judgment as an expert a device constructed to operate as shown in model, Exhibit 3, would or would not contain all the elements combined in substantially the same way as specified in claim 2 of the patent.

A. I have no doubt it would.

*Cross Examination.*

MR. WHEATON. Q. You spoke of the difference between a weight and a spring in a clock. You are aware that the old style of clocks originally all run with weights?

A. Yes sir.

Q. Suppose the next man had found an improvement to run that clock by a spring and taken out his patent for his spring alone, in that case would you consider that the weight was the equivalent mechanically, to that spring?

A. If that man was the inventor of a spring I should say that it was a patentable device. If the spring, however, had long been known and used, and the weights had long been known and used, and it was known that they would produce the same results when placed in substantially the same way, I should say if he was the first one to put it in a clock, it would not be patentable.

Q. Suppose that the gravity catches belonged to another inventor and the patent office so decided, and when the patent office instructed him of that fact, that he withdrew a claim which he was already making for spring or other catches, in that case would you consider that gravity catches were the equivalent of spring catches?

A. Yes sir, I should say so.

46

*Re-Direct Examination.*

MR. MILLER. Q. Explain why that is?

A. In the first place I cannot imagine the patent office doing any such thing. Further than that in the absence of anything in the specifications implying that they were considered equivalents by the inventor, and under those circumstances, it might perhaps be different, but that if there was a statement in the specifications that gravity catches might be used, and the patent office permitted the statement to stand, and issued the patent, then I should say that it appeared right on the face of the patent that the devices were considered in the patent office as equivalents.

Q. You speak of the fact that they made him strike out the words "or other."

A. Yes sir.

Q. Do they allow claims in the alternative in the patent office?

A. No sir.

Q. Then if a person had originally claimed springs or other catches and the patent office should have required him to strike out the words "or other" and he just had in his specifications the statement that gravity catches could be used, would you say that the action of the patent office was a ruling or adjudication or intimation of any kind that spring catches were not the equivalents of gravity catches?

A. I should say that the action of the patent office limited his patent to the use of springs or other catches, which are the equivalents of spring catches.

Q. You would consider the gravity catches to be the equivalents of spring catches?

A. Yes sir.

47 MR. WHEATON. Q. Suppose that the gravity catches were old, and that there was no difference between the old device and what the patent calls for, except the spring catches, would you then consider there was any patentable invention in applying the spring to the catches?

A. Where the gravity catches were old and had been used substantially in the same way, I should not apply for a patent for any one on that. I should not consider there was any patentable invention in it.

MR. MILLER. Q. We desire to offer in evidence another model which is a combination model showing both spring and gravity catches in one device. The said model was marked "Plaintiff's Exhibit No. 5."

J. W. CASSIDY was here recalled for further cross-examination.

MR. WHEATON. Q. At what time was the last royalty received by you from New York, as near as you can fix the date.

A. I think some six years ago as near as I can fix the date. Somewhere about 1885.

Plaintiff rests.

MR. WHEATON. We will ask your honor for an instruction that the jury should bring in a verdict for the defendant on the ground that the plaintiff's own testimony shows that the change that he made consisted of substituting these posts and spring catches—or other catches—I will not make a point on the word spring—for the chains and lugs in the same kind of a dryer.

THE COURT. The motion will be overruled.

*Second Exception.*

48 To which said ruling of the Court counsel for the defendant then and there duly excepted and hereby tenders this its bill of exceptions to the Court to sign and seal and the Court does.



hereby sign and seal the same.

(A duly certified copy from the records of the United States Patent Office, of the File Wrapper and Contents, in the matter of the letters patent granted to John W. Cassidy, dated January 25th, 1876, and numbered 172,608, for an Improvement in Drying Apparatus, was here introduced and read in evidence, marked Defendant's Exhibit 1, and the following is a copy thereof:

“ Department of the Interior, United States Patent Office.

“ To all persons to whom these Presents shall come, Greeting :

“ This is to certify that the annexed is a true copy from the  
 “ Records of this Office of, the File Wrapper and Contents, in the  
 “ matter of the letters patent granted to John W. Cassidy, January  
 “ 25th, 1876, Number 172,608, for Improvement in Drying Appar-  
 “ atus.

“ In testimony whereof I, W. E. Simonds, Commissioner of Pat-  
 “ ents, have caused the Seal of the Patent Office to be affixed this  
 “ 10th day of September, in the year of our Lord one thousand  
 “ eight hundred and ninety-one, and of the Independence of the  
 “ United States the one hundred and sixteenth.

“ [SEAL.] W. E. SIMONDS, *Commissioner*.

“ Model 1 dr. \$15. check.

“ *Petition.*

“ *To the Commissioner of Patents :*

“ Your Petitioner John Wintermute Cassidy of Petaluma, Cali-  
 “ fornia, prays that a patent may be granted to him for the inven-  
 “ tion set forth in the annexed specifications. And I do further

“ pray that you will recognize Dewey & Co., of San Fran-  
 49 “ cisco, Cal., and A. H. and R. K. Evans of Washington,

“ D. C. as my Attorneys, hereby appointed to alter or amend  
 “ the said specification, and to receive the letters patent when is-  
 “ sued.

“ JOHN W. CASSIDY.

“ *Oath.*

“ CITY AND COUNTY OF SAN FRANCISCO, }  
 STATE OF CALIFORNIA, } ss.

“ On this 2d day of February 1875 before the subscriber person-  
 “ ally appeared the within named John Wintermute Cassidy and  
 “ made solemn oath that he verily believes himself to be the or-  
 “ iginal and first inventor of the Drying Apparatus herein de-  
 “ scribed and that he does not know or believe that the same was  
 “ ever before known or used, and that he is a citizen of the United  
 “ States.

“ (L. S.)

F. O. WEGENER.

“ *Notary Public.*

“ *To all whom it may concern :*

“ Be it known that I, JOHN W. CASSIDY, of Petaluma, Sonoma  
 “ county, State of California, have invented a Drying Apparatus;

“ and I do hereby declare the following description and accompanying drawings are sufficient to enable any person skilled in the art or science to which it most nearly appertains, to make and use my said invention without further invention or experiment.

“ My invention relates to an improved device for desiccating fruit and other substances by means of artificial heat; and it consists, first, in a novel method of utilizing the heat which passes

50 “ through the flues from the furnace, and by leading these flues around the chamber within suitable pipes or cases,

“ and making certain openings from these cases into the chamber, I am enabled to admit heated air from any or all sides, and at different heights between the layers of fruit, while heat is also admitted from the bottom of the chamber, or not as may be desired.

“ My invention also consists in a novel means of moving the fruit within the chamber, from the time it is admitted until it is again removed.

“ Referring to the accompanying drawings for a more complete explanation of my invention, Figure 1 is a perspective view of my invention, with a portion of the chamber broken away. Fig. 2 is a vertical section in elevation.

“ A is the chamber of a drier, and it is made of considerable height, so that the fruit can be admitted from below and moved upward to the place of removal from the chamber. The furnace or heater is placed below the chamber, and the heated air is admitted through openings made in the bottom of the chamber, as shown at B, if desired, but the principal part of the heat, the smoke, and gases of combustion are conveyed away from the furnace by means of flues C, which necessarily carry off considerable heat. This heat is ordinarily lost, but I utilize it, and, at the same time, use it at points where it will be of more value than at present, by introducing it at various points around the chamber, and horizontally between the trays. In order to do this I carry the flues C over the bottom plate of the chamber from the center to opposite sides D, where they pass upward a short distance

51 “ within inclosing-cases, as shown at E, and these cases, opening toward the interior of the chamber, will direct the

“ heat of the flues into it up to the point where they turn, and are carried diagonally across their respective sides E to the corners, as shown at F. From the corners the flues are again carried diagonally across the two remaining fronts G, and in opposite directions. The flues are also inclosed in cases H on these two sides, and slots I are cut from the cases, so as to open into the chamber and admit another portion of the heated air between the layers of fruit at different heights. After crossing the faces G, the flues are again bent so as to cross the sides D diagonally until they reach the center, when they are carried into the vertical cases J

which extend to the top of the drier. Openings *m* are made from the cases *J*, and thus another portion of heat is admitted to the chamber near the top, to finish the operation. From this point the flues may be carried up along the dome to a central discharge-opening or chimney.

Various equivalent methods of leading the flues and utilizing their heat may be employed and will readily suggest themselves, but I have found the present arrangement the simplest and most economical, and I am thus enabled to introduce the heat at right angles with the travel of the fruit, and at any point.

In order to elevate and support the trays of fruit after they are introduced, I have employed a combination of movable and stationary standards upon two opposite sides of the chamber, and these standards are provided with spring-catches, which can be forced  
52 inwards to allow a tray to pass up, but will return to their place after it passes and prevent its going down.

Four stationary standards, *K K*, are set into the sides of the chamber, and extend vertically from top to bottom near the corners. The other four, *L L*, can be moved up and down in slots, and stand by the side of the standards *K*. Each set of standards is provided with spring-catches or supports which are formed as shown  
t. E at *n* and *n'*, so that a tray moving upward will depress them into the posts, but they will spring out after it passes.

The operation will then be as follows: A tray full of fruit being  
this introduced through the lower door *t* will rest upon four pins projecting from the movable standards or posts. These posts then  
ery being elevated, by means hereafter described, the tray will be carried up until it passes the first set of catches *n*, upon the posts *K*.  
The posts *L* are then allowed to descend, and will leave the tray  
resting upon these catches. As the posts *L* descend, four similar  
catches, *n'*, upon them will be depressed and pass below the tray; so that when they are again elevated these last catches will lift the  
tray above the next set upon the stationary posts, and, in this manner, the trays are gradually moved from the bottom to the top of the chamber, where they are removed by the door *s*. Catches which would fall out by gravitation might be substituted for the springs, in some cases. The movable posts *L* may be elevated and depressed in many ways, as by cams, eccentrics, &c., but in the present case I have employed a central roller, *O*, with a crank at one end. Upon this roller cords or chains *P* are coiled, and their opposite ends, after passing over friction rollers *Q, Q*, are secured to the lower ends  
of the posts *L*. By turning the crank, the chains will be  
53 coiled upon the roller *o*, and the posts lifted, simultaneously.

If necessary, spiral or other springs *r* may be employed to cause the posts to descend, but in the full-sized machine the weight will be sufficient.

Having thus described my invention, what I claim as new, and

desire to secure by Letters Patent, is—

First. The flues C passing around the drying chamber as shown, being enclosed at E, H, J and having openings I, *m* leading into the drying chamber from the cases, substantially as and for the purpose herein described.

Second. The device consisting of the stationary posts K and the vertically moving posts L, provided with the spring or other catches *n, n*, together with means for moving the posts L for the purpose of elevating the trays substantially as herein described.

In witness whereof, I hereunto set my hand and seal.

Witnesses: JOHN W. CASSIDY. (L. S.)

1. GEO. H. STRONG,

2. JNO. L. BOONE.

(Endorsed :) U. S. Patent Office Mar. 8, 1875.

M. E. C. Mar. 16, 1875.

Examiner's Room No. 100. U. S. Patent Office.  
Washington, D. C., Mar. 16, 1875.

JOHN W. CASSIDY,  
Care A. H. & R. K. EVANS, | 'Drying Apparatus.'  
Washington, D. C. | Mar. 8, 1875.

The operation described on last half of page 5 of spec'n is very imperfectly illustrated in the drawing. The door s, page 6, is lacking.

54. The claims are not in the preferred form, fruit-dryers being old, applicant's invention, if he has made any, must consist in some novel feature or combination of features, *in* a fruit dryer, and this, it is suggested, is what should be claimed.

For the first claim reference is made to *Dryers*, A. Mackey, 137,459, Apr. 1, 1873; Harrison & Savery, 156,849 Nov. 17, 1874; *Fruit Dryers*; Mayhew, 94,967, Sept. 21, 1869; *Grain Dryers*; Eaton, 115,833, June 13, 1871.

For 2d claim see *Fruit Dryers*, M. P. Smith, 107,417, Sept. 13, 1870, reissued; J. O. Button, 155,286, Sept. 22, 1874, and A. C. Lewis, 29,390, July 31, 1860.

The application is rejected.

1586

J. A. ASHLEY,  
*2d Assistant.*

W. OSGOOD.

(Endorsed :) 1586, Off. Mar. 16, 1875.

In the matter of John W. Cassidy, Fruit Dryer, filed Mar. 8, '75.

And now comes the said applicant by his att'ys and amends as follows:

Erase the claims and substitute the following:

1. In combination with the drying chamber, the pipes or flues C passing diagonally along the slotted openings I around and outside of the dryer, and provided with coverings E, H, J, substantially as and for the purpose set forth.

2. In combination with a dryer, the stationary posts provided with spring catches *n n* ~~both the latter~~ K,  $\wedge$  and the vertically moving posts L,  $\wedge$  all provided with the spring catches *n' n'* and suitable mechanism for operating the posts L, substantially as and for the purpose set forth.

JOHN W. CASSIDY,  
per A. H. EVANS & CO.

55

*To the Com'r of Patents:—*

Sir—If the patent be allowed this applicant, we will have an additional figure made, illustrating more clearing the posts K & L as suggested. We have properly lettered the door *s*, and as the Claims are now substituted they will be found, we think free from objection—and not anticipated.

A. H. EVANS & CO.

*Att'ys.*

(Endorsed) U. S. Patent Office Mar. 18, 1875. U. S. A.

J. W. Cassidy Amendment 126—1586 Room 100 Mar 19, '75. A.

Examiner's Room No. 100. U. S. Patent Office.

Washington, D. C. March 27, 1875.

John W. Cassidy, Care A. H. & R. K. Evans | Drying Apparatus.  
Washington D. C. | March 8, 1875.

It is believed that the claims presented in the amendment filed 19th. inst. are free from objection, and that the application may be allowed on receipt of a suitable additional drawing as suggested by the attorneys.

W. OSGOOD. 1586. J. W. ASHLEY, *2d Assistant.*

(Endorsed) 126, 1586, Letter, 27 Mar. '75. 3 Memorandum of  
Fee paid at U. S. Patent Office.

Serial No. \_\_\_\_\_

Inventor: J. W. Cassidy, Patent to be issued to Inventor.

Name of Invention, as allowed; Drying Apparatus.

Date of Payment; May 26th. Fee, 1 Final. Solicitor A. H. Evans & Co.

U. S. A. Patent Office May 26, 1875.

L. L. A. 2-6-75.

DEPARTMENT OF THE INTERIOR.

56 U. S. Patent Office, Washington, D. C. June 2, 1875.

John W. Cassidy, Care A. H. & R. K. Evans.

Please find below a copy of a communication from the Examiner concerning your application for patent for "Drying Apparatus" dated the eighth day of March, 1875.

Very respectfully,

Room 100.

J. M. THACHER, *Commissioner.*

Your case above referred to is adjudged to interfere with the application of Albert J. Rice, for patent for Fruit Dryer, filed April 23, 1875, Alexander & Mason, Washington, D. C. his attorneys,

and the question of priority will be determined in conformity with the rules accompanying this. The preliminary statement demanded by Rule 53 must be sealed up and filed on or before the first Tuesday of July, 1875, with the subject of invention and name of party filing it, indorsed on the envelope.

The subject matter involved in the interference is: the combination of stationary posts provided with spring catches with vertically movable posts carrying drying frames and provided with similar spring catches, and with suitable mechanism for operating the same; as in applicant's second claim.

1586.

J. A. ASHLEY, *2d Assistant*.

W. OSGOOD.

(Endorsed). 1586 Off. June 2, '75.

Washington, D. C. July 1, 1875.

*Hon. Comr. of Patents:*

57 Sir:—In the matter of the interference Rice vs. Cassidy for a "Fruit Dryer," we ask that—in view of negotiations pending between the two parties—the time for filing preliminary statements be extended not less than two weeks.

Respectfully,

A. H. EVANS & CO. *Attys. for Cassidy.*  
*Attys. for Rice,* ALEXANDER & MASON.

(Endorsed :) In the U. S. Patent Office. Rice vs. Cassidy. The time for filing preliminary statements in the above entitled case is extended till 20th July, 1875.

M. B. PHILIPP,

*Ex. of Interferences.*

7 July, 1875.

*(Interference.)*

F. B. J.

14, 9, '75.

DEPARTMENT OF THE INTERIOR.

U. S. Patent Office, Washington, D. C., Sept. 14, 1875.

John W. Cassidy, Care A. H. &amp; R. K. Evans.

*Present:* Please find below a copy of a communication from the Examiner concerning your application for Drying Apparatus, dated the eighth day of March, 1875.

Respectfully, &amp;c.,

*Commissioner.*

Room No. 100.

Your case above referred to is adjudged to interfere with the application Albert J. Rice, Fruit Dryer, filed Apr. 23, 1875, Alexander & Mason, his attys. and Sam'l W. Craven, Dry House, filed Aug. 7, 1875, Chipman Hosmer & Co. his attys., and the question of priority will be determined in conformity with the rules accompanying this. The preliminary statement demanded by rule

53 must be sealed up and filed on or before the third Tuesday of October, 1875, with the subject of invention and name of party filing it, indorsed on the envelope. The subject matter involved in the interference is—the combination of stationary posts provided with spring-catches, with vertically moving posts carrying drying frames and provided with similar spring catches and with suitable mechanism for operating the same, as in applicant's second claim.

1586.

J. H. ASHLEY,  
*2d Assistant.*

W. OSGOOD.

(Endorsed :) 126, 1586. Off. Aug. 14, 1875.

*(Interference.)*

F. B. J.

20, 9, '75.

## DEPARTMENT OF THE INTERIOR.

U. S. Patent Office, Washington, D. C., Sept. 20, 1875.

John W. Cassidy, Care A. H. &amp; R. K. Evans.

*Present:* Please find below a copy of a communication from the Examiner, concerning your application for Pat. for Drying Apparatus dated the Eighth day of March, 1875.

Respectfully, &amp;c.,

J. M. THACHER,  
*Commissioner.*

Room No. 100.

Your case above referred to is adjudged to interfere with the appl'n of S. W. Craven for Pat. for Dry House, filed Aug. 7, 1875, and the question of priority will be determined in conformity with the rules accompanying this. The preliminary statement demanded by Rule 53 must be sealed up and filed on or before the 19th day of October, 1875, with the subject of invention and the name of the party filing it indorsed on the envelope.

59 The subject matter involved in the interference is: the combination of stationary posts provided with spring catches, with vertically movable posts carrying drying frames and provided with similar spring catches and with suitable mechanism for operating the same; as in applicant's second *claim*.

The interference dated 14th inst. is dissolved by order of the commissioner. Craven's attorneys are Messrs. Chipman Hosmer & Co. of this city.

126, 1586.

W. OSGOOD.

(Endorsed :) 126, 1586. Off. Sept. 20, 1875.

126, 1586, 1875.

No. 172,608.

John W. Cassidy of Petaluma, County of Sonoma, State of California.

*Drying Apparatus.*

Recd.	March 8, 1875.	
Petition	" " "	
Affidavit	" " "	
Specification	" " "	
Drawing	" " "	
Model	" " "	
Cert. Dep. Cash \$15	" " "	
Add'l Fee Cert. \$20	Jan. 19, 1876.	
" " Cash \$20	May 26, 1875.	
Examined	Dec. 28, 1875.	W. Osgood.
Issue	Dec. 28, '75.	Knight.
Patented	Jan. 25, 1876.	
Circular	Dec. 29, 1875.	

DEWEY &amp; CO, San Francisco, Cal.

A. H. &amp; R. K. EVANS, Present.

1875.

60

*Contents.*

## Application Paper.

- |                             |                  |
|-----------------------------|------------------|
| 1. Rejected                 | 16, Mar., 1875.  |
| 2. Amdt.                    | Mar. 19, '75.    |
| 3. Letter                   | 27, Mar., 1875.  |
| 4. Intf.                    | 2d, June, 1875.  |
| 5. Hearing for              | Aug. 19, 1875.   |
| 6. Intf.                    | 14, Sept., 1875. |
| Dissolved by order of Comr. | Sept. 16, 1875.  |
| 7. Intf.                    | Sept. 20, 1875.  |

Dryer &amp; Dryers.

Title.

UNITED STATES PATENT OFFICE.

John W. Cassidy, of Petaluma, California.

*Improvement in Drying Apparatus.*Specification forming part of Letters Patent No. 172,608, dated  
January 25, 1876.

Application filed March 8, 1875.

*To all whom it may concern :*

Be it known that I, John W. Cassidy, of Petaluma, Sonoma County, State of California, have invented a Drying Apparatus; and I do hereby declare the following description and accompanying drawings are sufficient to enable any person skilled in the art or science to which it most nearly appertains, to make and use my said invention without further invention or experiment.

My invention relates to an improved device for desiccating fruit and other substances by means of artificial heat; and it consists, first, in a novel method of utilizing the heat which passes through the flues from the furnace, and by leading these flues around the

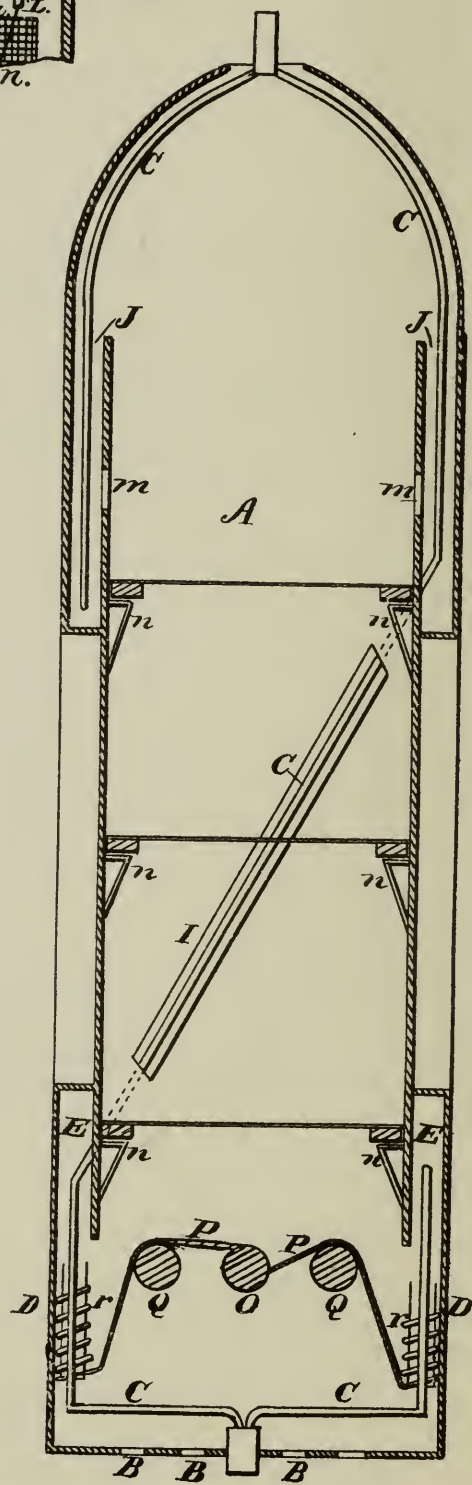
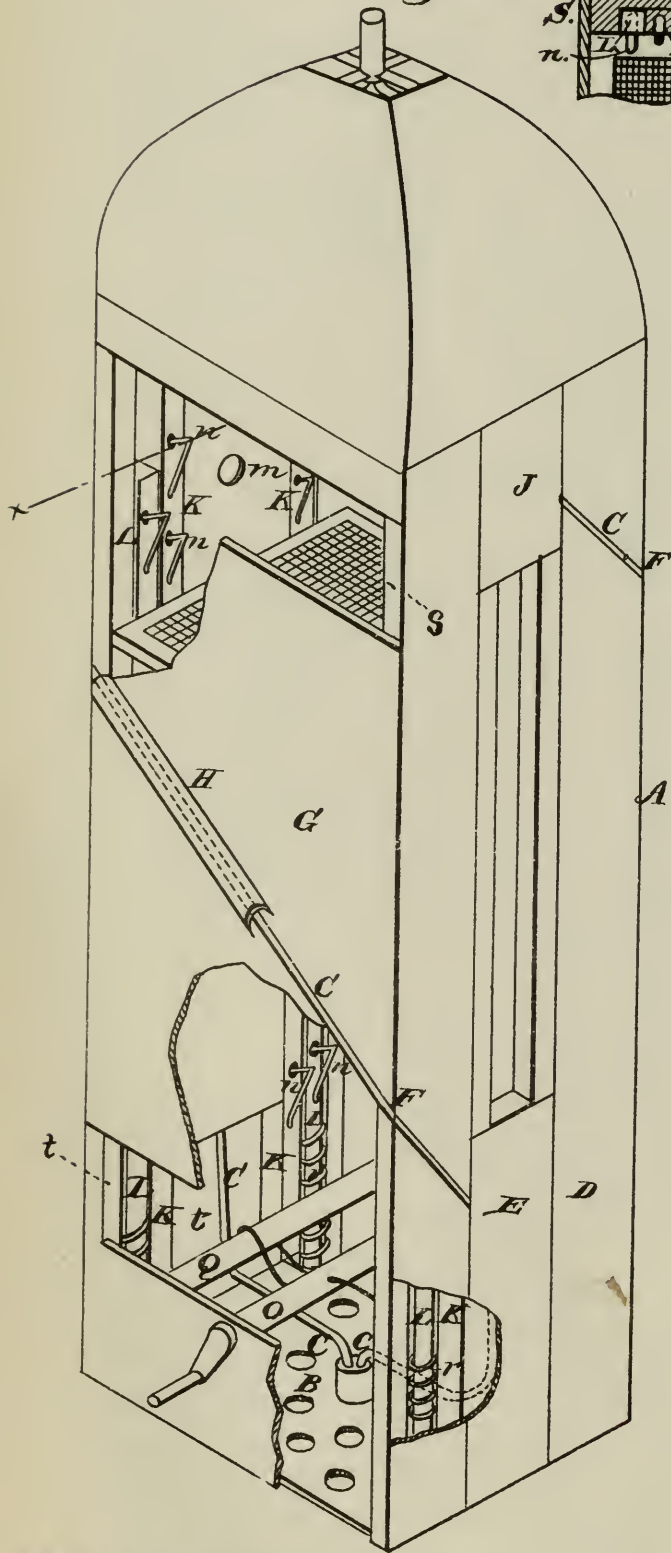
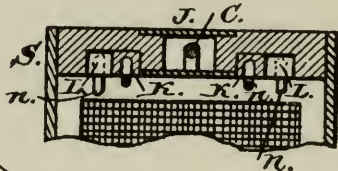



Fig. 1.

Fig. 3.

Fig. 2.



Witnesses  
 Geo. H. Strong  
 Jno. L. Boone

Inventor  
 John. W. Cassidy  
 by Dewey & Co.

chamber within suitable pipes or cases, and making certain openings from these cases into the chamber, I am enabled to admit heated air from any or all sides, and at different heights between the layers of fruit, while heat is also admitted from the bottom of the chamber, or not, as may be desired.

My invention also consists in a novel means of moving the fruit within the chamber, from the time it is admitted until it is again removed.

Referring to the accompanying drawings for a more complete explanation of my invention, Figure 1 is a perspective view of my invention, with a portion of the chamber broken away. Fig. 2 is a vertical section in elevation.

A is the chamber of a drier, and it is made of considerable height, so that the fruit can be admitted from below and moved upward to the place of removal from the chamber. The furnace or heater is placed below the chamber, and the heated air is admitted through openings made in the bottom of the chamber, as shown at B, if desired, but the principal part of the heat, the smoke, and gases of combustion are conveyed away from the furnace by means of flues C, which necessarily carry off considerable heat. This heat is ordinarily lost, but I utilize it, and, at the same time, use it at points where it will be of more value than at present, by introducing it at various points around the chamber, and horizontally between the trays. In order to do this I carry the flues C over the bottom plate of the chamber from the center to opposite sides D, where they pass upward a short distance within inclosing-cases, as shown at E, and these cases, opening toward the interior of the chamber, will direct the heat of the flues into it up to the point where they turn, and are carried diagonally across their respective sides E to the corners, as shown at F. From the corner the flues are again carried diagonally across the two remaining fronts G, and in opposite directions. The flues are also inclosed in cases H on these two sides, and slots I are cut from the cases, so as to open into the chamber and admit another portion of the heated air between the layers of fruit at different heights. After crossing the faces G, the flues are again bent so as to cross the sides D diagonally until they reach the center, when they are carried into the vertical cases J which extend to the top of the drier. Openings *m* are made from the cases J, and thus another portion of heat is admitted to the chamber near the top, to finish the operation. From this point the flues may be carried up along the dome to a central discharge opening or chimney.

Various equivalent methods of leading the flues and utilizing their heat may be employed and will readily suggest themselves, but I have found the present arrangement the simplest and most economical, and I am thus enabled to introduce heat at the right angles with the travel of the fruit, and at any point.

In order to elevate and support the trays of fruit after they are introduced, I have employed a combination of movable and stationary standards upon two opposite sides of the chamber, and these standards are provided with spring catches, which can be forced inward to allow a tray to pass up, but will return to their place after it passes and prevent its going down.

Four stationary standards, K K, are set into the sides of the chamber, and extend vertically from top to bottom near the corners. The other four, L L, can be moved up and down in slots, and stand by the side of the standards K. Each set of standards is provided with spring-catches or supports which are formed as shown at  $n$  and  $n'$ , so that a tray moving upward will depress them into the posts, but they will spring out after it passes.

The operation will then be as follows: A tray full of fruit being introduced through the lower door  $t$  will rest upon four pins projecting from the movable standards or posts. These posts being then elevated, by means hereinafter described, the tray will be carried up until it passes the first set of catches  $n$ , upon the posts K. The posts L are then allowed to descend, and will leave the tray resting upon these catches. As the posts L descend, four similar catches,  $n'$ , upon them will be depressed and pass below the tray, so that when they are again elevated these last catches will lift the tray above the next set upon the stationary posts, and, in this manner, the trays are gradually moved from the bottom to the top of the chamber, where they are removed by the door  $s$ . Catches which would fall out by gravitation might be substituted for the springs, in some cases. The movable posts L may be elevated and depressed in many ways, as by cams, eccentrics, &c., but in the present case I have employed a central roller, O, with a crank at one end. Upon this roller cords or chains P are coiled, and their opposite ends, after passing over friction-rollers Q Q, are secured to the lower ends of the posts L. By turning the crank, the chains will be coiled upon the roller  $o$ , and the posts lifted, simultaneously. If necessary, spiral or other springs  $r$  may be employed to cause the posts to descend, but in the full-sized machine the weight will be sufficient.

Having thus described my invention, what I claim as new, and desire to secure by Letters Patent, is—

1. In combination with a drying-chamber, the pipes or flues C passing diagonally along the slotted openings I, around and outside of the drier, and provided with coverings E H J, substantially as and for the purpose set forth.

In combination with a drier, the stationary posts K, provided with spring-catches  $n n$ , and the vertically moving posts L, provided with the spring-catches  $n' n'$ , and suitable mechanism for operating the posts L, substantially as and for the purpose set forth.

In witness whereof I hereunto set my hand and seal.



DRYING-HOUSE.

No. 179,275.

Patented June 27, 1876

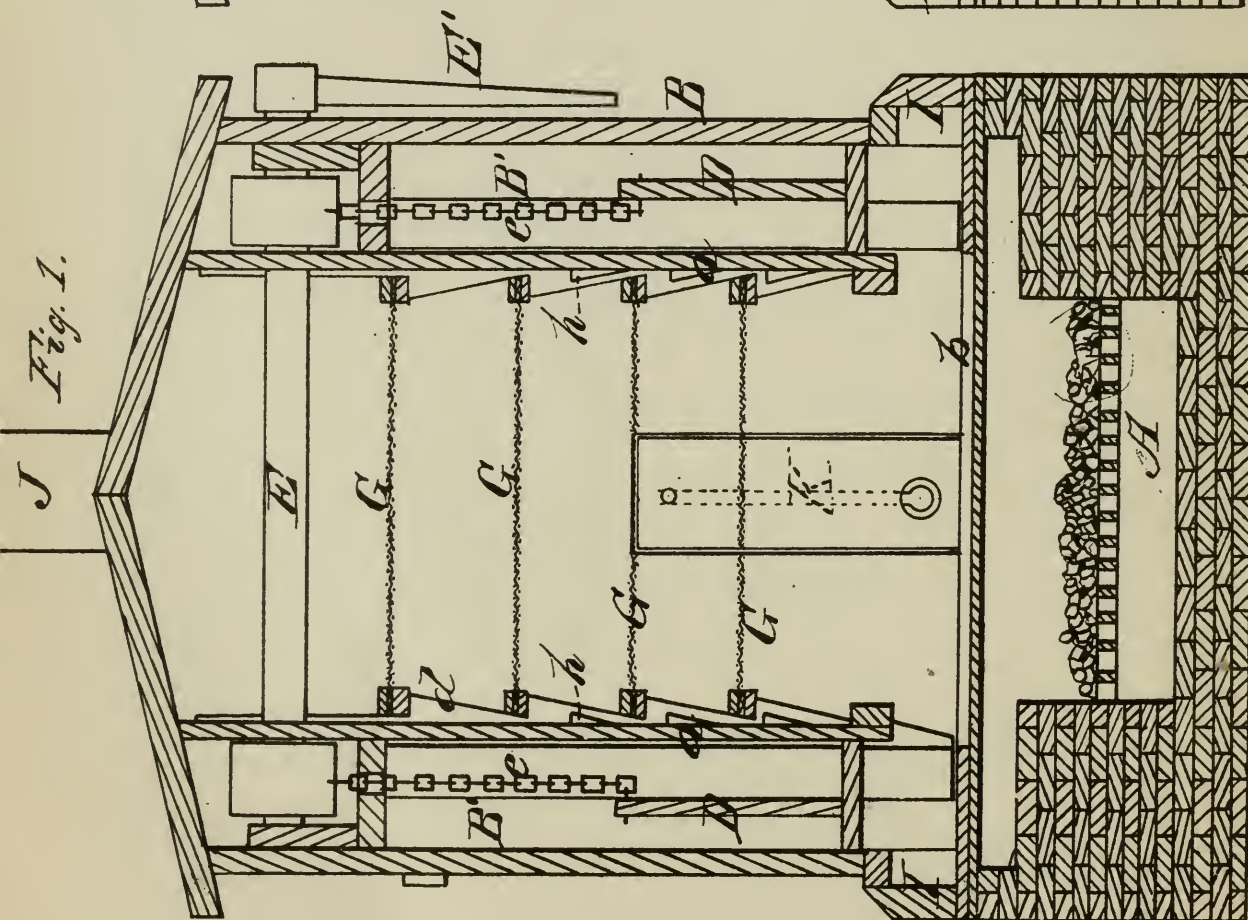
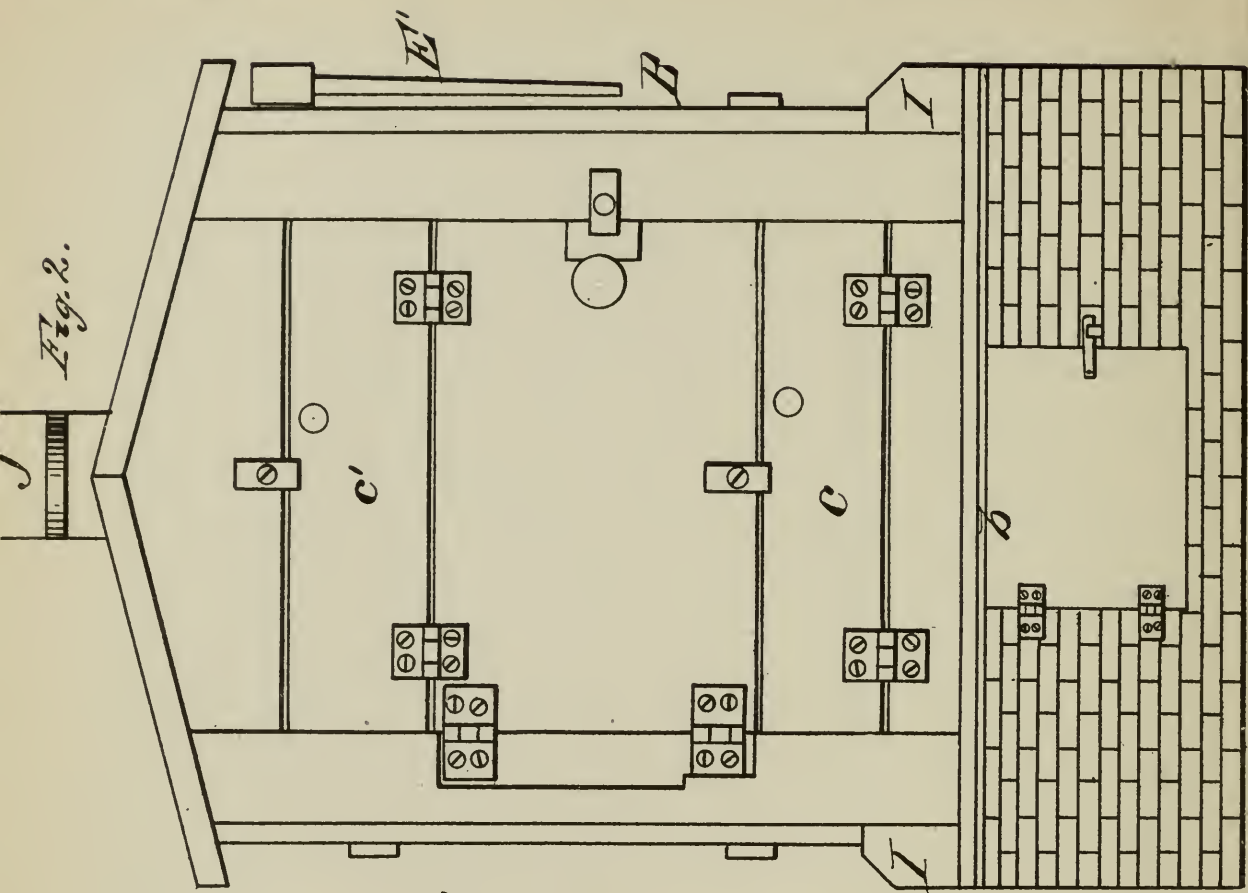

WITNESSES

Eng. W. Johnson.

INVENTOR

Samuel W. Graves.



S. W. CRAVEN.  
DRYING-HOUSE.

No. 179,275.

Patented June 27, 1877.

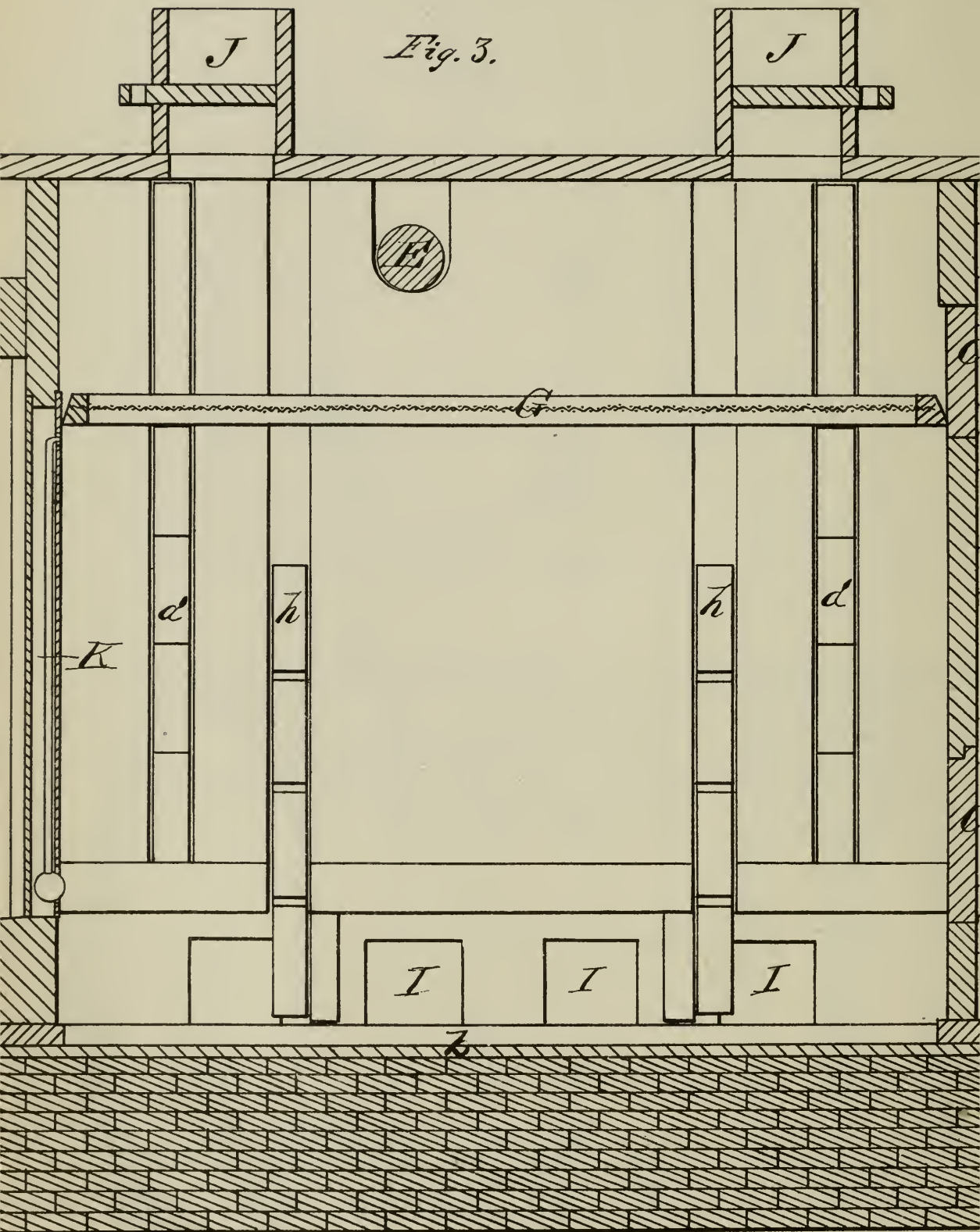

WITNESSES

*Eugene W. Johnson*

INVENTOR

*Samuel W. Craven*





S. W. CRAVER.  
DRYING-HOUSE.

No. 179,275.

Patented June 27, 1876

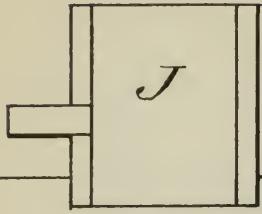
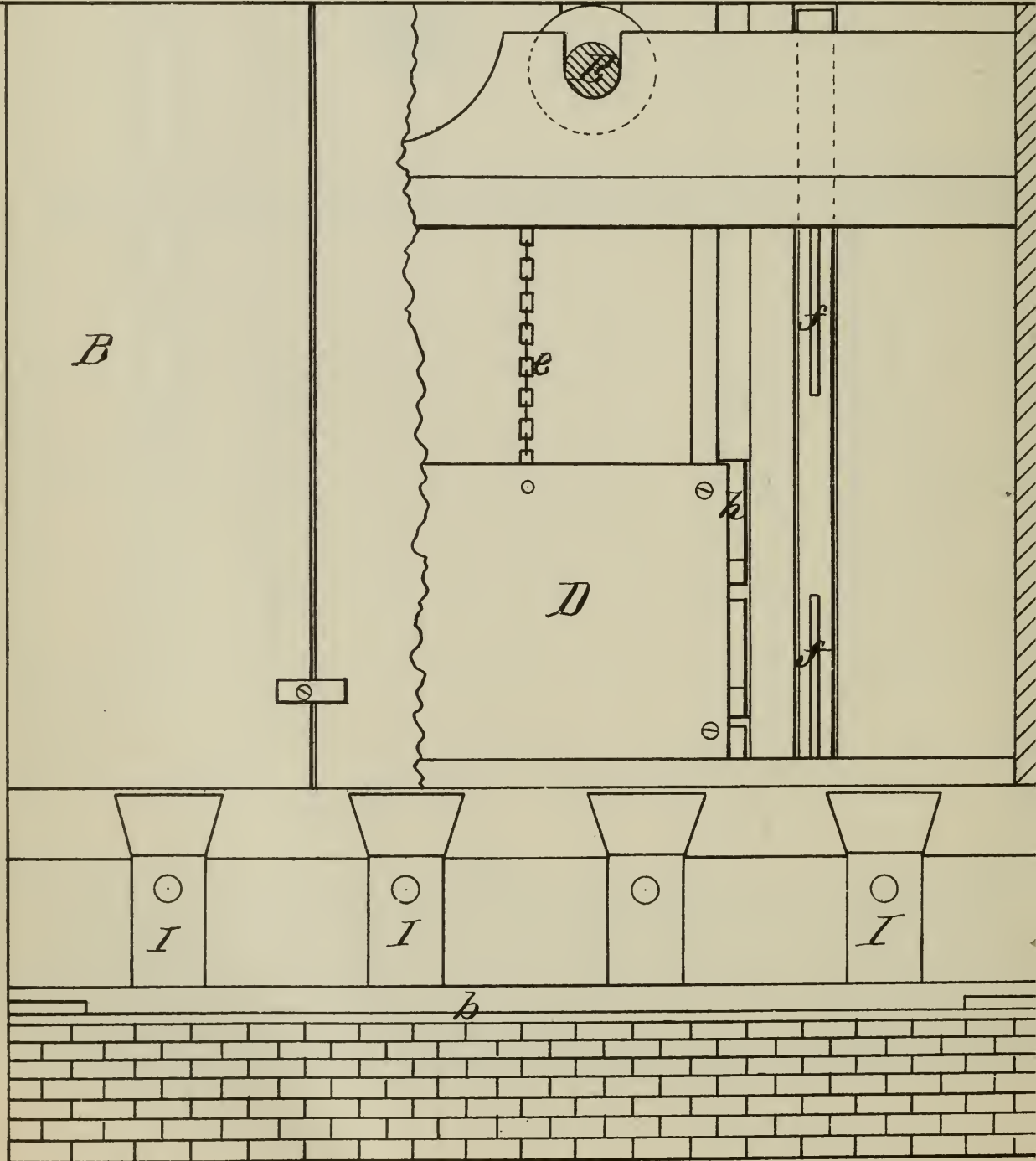
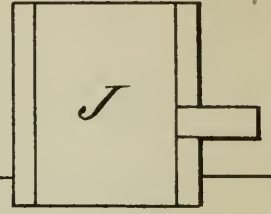

Fig. 4.



WITNESSES

*Geo. W. Johnson*

INVENTOR

*Samuel W. Craver*



S. W. CRAVEN.  
DRYING-HOUSE.

No. 179,275.

Patented June 27, 1876.

*Fig. 5.*

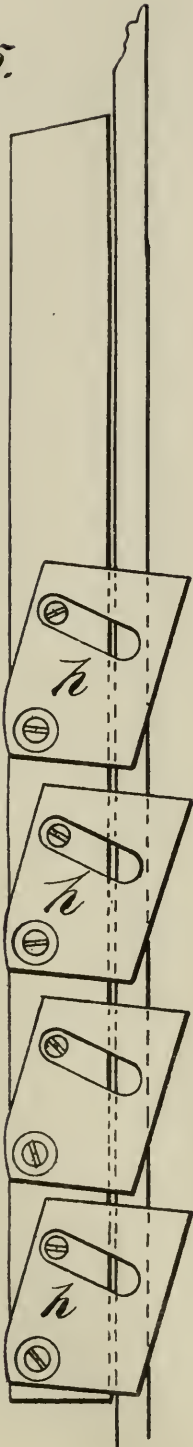

*Fig. 6.*

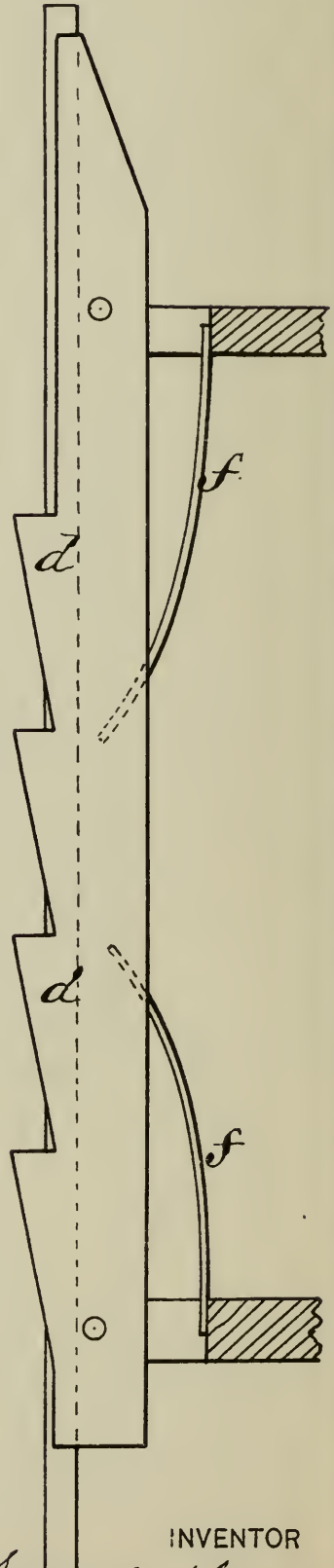

WITNESSES

*Samuel W. Craven*

INVENTOR

*Samuel W. Craven.*

[SEAL.]

JOHN W. CASSIDY.

Witnesses:

GEO. H. STRONG,

JNO. L. BOONE.

61 MR. WHEATON. I will introduce in evidence a copy of the specifications and drawings of the patent issued to Mr. Craven who is named as one of the interfering parties in the record just read.

(Following is a copy of the specifications and drawings of said patent:

UNITED STATES PATENT OFFICE,  
Samuel W. Craven, of Cobden, Illinois.

*Improvement in Drying House.*

Specifications forming part of Letters Patent No. 179,275 dated  
June 27, 1876.

Application filed August 7, 1875.

*To all whom it may concern.*

Be it known that I, Samuel W. Craven, of Cobden, in the county of Union and State of Illinois, have invented a new and valuable Improvement in Dry-Houses; and I do hereby declare that the following is a full, clear and exact description of the construction and operation of the same, reference being had to the annexed drawings, making a part of this specification, and to the letters and figures of reference marked thereon.

Figure 1 of the drawings is a representation of a transverse vertical section of my dry-house, and Fig. 2 is a front view of the same. Fig. 3 is a longitudinal vertical sectional view thereof; and Fig. 4 is a side view, part sectional. Figs. 5 and 6 are detail views.

My invention relates to dry-houses particularly for drying fruit; and it consists in the construction and novel arrangement of the dry-house, provided with sliding frames, employed, in connection with yielding sliding rack or latch bars, for raising the trays, springs, and pivoted gravitating-latches, for supporting the trays, all as hereinafter more fully set forth.

In the accompanying drawing, A represents a furnace, of any suitable construction, upon which the dry-house B is erected. In the front of this house is a bottom door, C, and top door, C', as shown; and near each side is a vertical partition, *a*, extending from the top to near the bottom *b*, said bottom being made of sheet metal, and separating the dry-house from the furnace.

By means of the partitions *a* there is thus formed a chamber, B'; along each side of the dry-house, in which is a sliding frame, D, which frames are suspended by chains *e e* from a shaft E passing through the upper part of the dry-house, and having a crank or handle, E', at one end, for turning the same. To each frame D are connected two upright latch bars, *d d*, which are held outward

through slots in the partitions *a a* by means of springs *f f*. In these partitions are also arranged vertical series of gravitating-latches *h h*, which are pivoted at their lower ends, and their upper ends fall by their own gravity inward into the drying-chamber.

The frames *D D* being lowered, the latches *d* and *h* correspond—that is, they are on horizontal lines with each other. The lower front door *C* being opened, one tray, *G*, may be inserted, and supported upon the lower sets of latches, *d h*, two of each kind on each side.

By means of the windlass *E E'* the frames *D* and latch bars *d* are raised vertically, lifting the tray *G* over the next set of gravitating-latches *h*, which fold backward to allow the tray to pass; and as soon as the tray has passed them, they fall inward again of their own gravity to support the tray. The frames *D* then fall again, the latch bars *d* yielding to pass the tray. A second tray is then put in on the first set of latch bars; and then the two elevated in the same manner as described for the first, and so on till the fruit on the first tray is thoroughly dried, when said tray is removed through the upper front door *C'*.

Along each side of the dry-house is a series of ventilating-slides, *I I*, one or more of which may be opened to admit the required quantity of cold air to regulate the temperature. *J J* are chimneys, through which the vapors escape. *K* is a thermometer in the side of the dry house, to show the state of the temperature therein.

What I claim as new, and desire to secure by letters patent, is—

The combination, with the frames *D*, of the latch-bars *d*, springs *f*, and the pivoted gravitating latches *h*, substantially as and for the purpose set forth.

In testimony that I claim the above I have hereunto subscribed my name in the presence of two witnesses.

Witnesses:

SAMUEL W. CRAVEN.

L. T. LINNELL,

C. T. PIERCE.

62 MR. MILLER. We object to that patent. It is subsequent to the date of our patent.

MR. WHEATON. This is offered for the purpose of showing that in the decision of the patent office whatever it was on that interference, the spring catches were awarded to Mr. Cassidy, while the catches without springs were awarded to Mr. Craven, and the patent was granted to him, having the claim which included those in the patent.

THE COURT. I do not think the judgment of the patent office can be proven in that way. The objection is sustained.

*Third Exception.*

To which ruling of the Court, counsel for the defendant then and there duly excepted and hereby tenders this its bill of exceptions to the Court to sign and seal and the Court does hereby sign and seal the same.

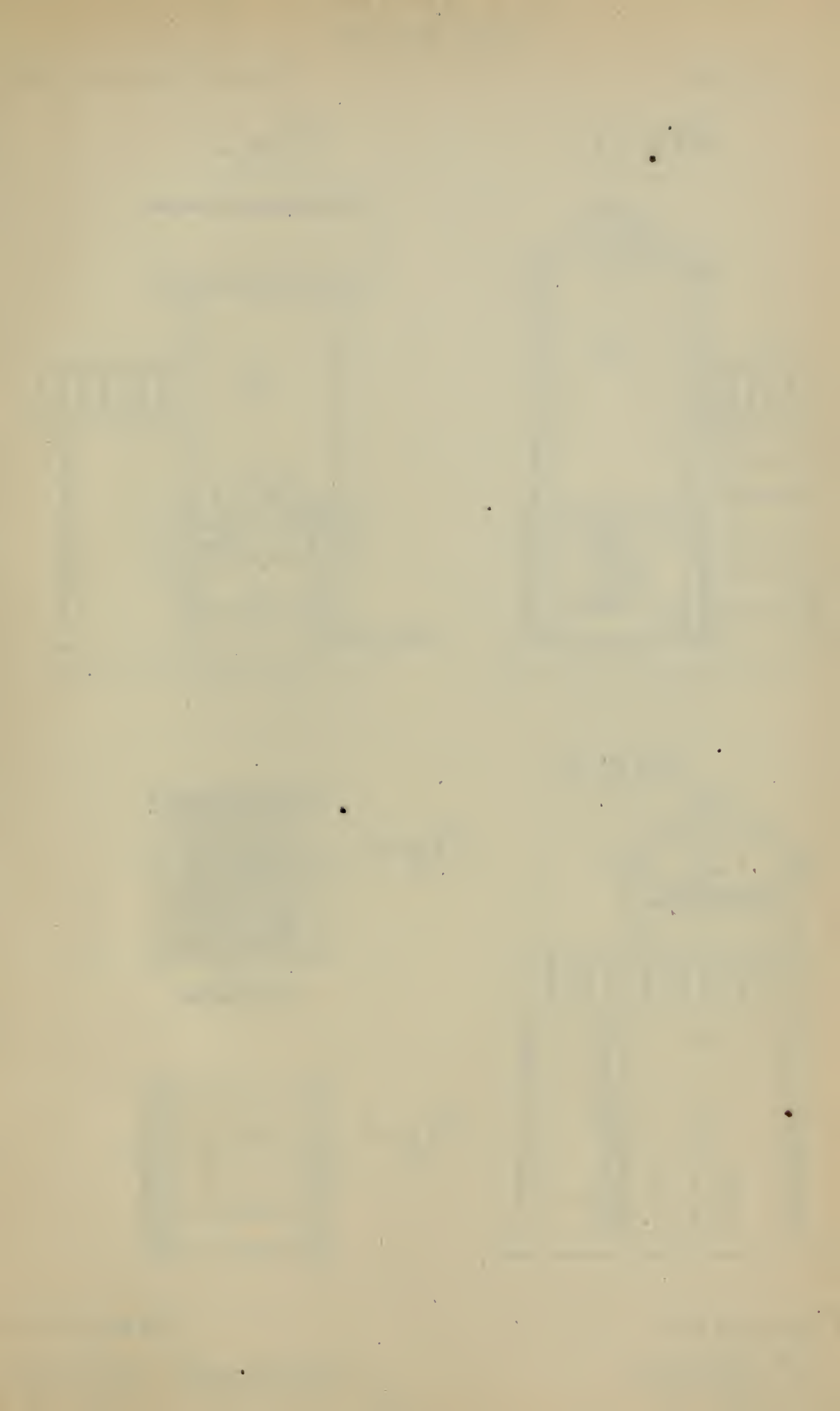

J. O. BUTTON.  
Fruit-Driers.

No. 155,286.

Patented Sept. 22, 1874.

Fig. 6.

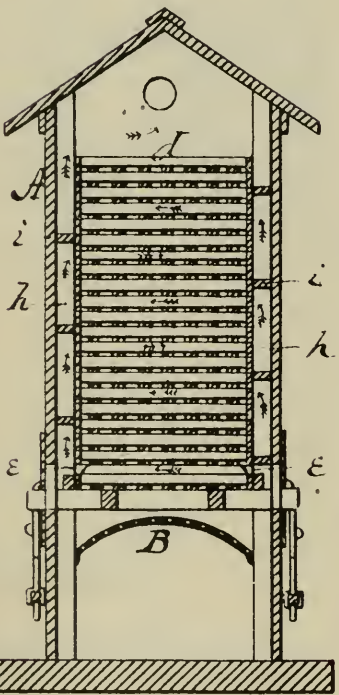
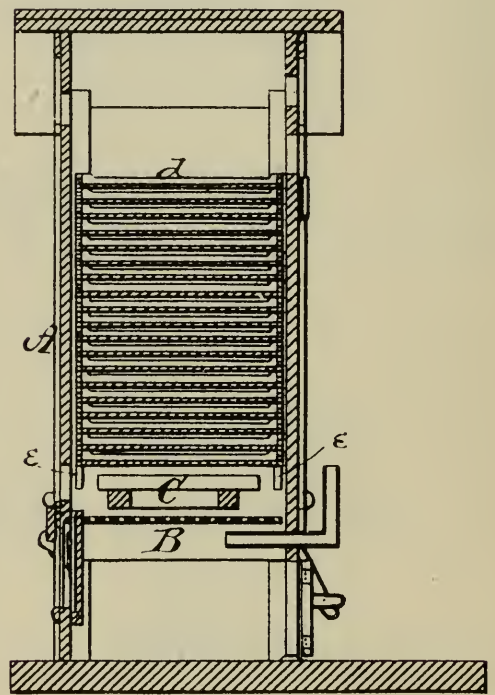

Fig. 7.



Witnesses;  
P. Himes,

Inventor,  
J. Orlando Button



MR. KIERCE. For the purpose of getting around any objections that may hereafter be urged, that we did not have any stipulation as to the use of these ordinary patent office copies we put in this stipulation.

MR. MILLER. I do not object on that ground.

The stipulation here offered was introduced in evidence, and the following is a copy thereof:—

“ It is hereby stipulated and agreed, by and between the respective parties hereto, that either party may introduce in evidence on the trial of said cause, in lieu of the originals of the United States Letters Patents, or certified copies thereof, such patent office copies of the specifications and drawings of such patents as they may desire with the same force and effect as the original patents, or certified copies thereof would have and that the dates of the granting of said Letters Patent as therein contained shall be accepted as true.

“ It is further stipulated that the defendant is a corporation as alleged in the Declaration herein filed.

“ Dated, December 2nd, 1891.

“ LANGHORNE & MILLER,

“ *Attorneys for Plaintiff.*

“ WHEATON, KALLOCH AND KIERCE,

“ *Attorneys for Defendant.*”

(Defendant here offered in evidence, a copy of United States Letters Patent, granted to J. O. Button, September 24th, 1874, numbered 155,286, for a “Fruit Dryer,” of which the following is a copy, and which was read to the Jury.

UNITED STATES PATENT OFFICE.

Joel Orlando Button, of Hopkins, Michigan.

*Improvement in Fruit-Driers.*

Specification forming part of Letters Patent No. 155,286, dated September 22, 1874.

Application filed July 20, 1874.

*To all whom it may concern:*

Be it known that I, JOEL ORLANDO BUTTON, of Hopkins, in the county of Allegan and State of Michigan, have invented certain new and useful Improvements in Fruit and Vegetable Driers; and I do hereby declare the following to be a full, clear, and exact description thereof, reference being had to the accompanying drawing and to the letters of reference marked thereon, forming part of this specification, and in which—

Figure 1 is a front view, Fig. 2 a side elevation, and Fig. 3 a rear view, of my drier; Figs. 4 and 5 are horizontal sections, and Figs. 6 and 7 vertical sections, of the same.

A represents the shell of the drier, provided with a suitable hot-air furnace in the bottom, over which is an arch, B, of sheet iron.

This arch is perforated, as shown in Figs. 6 and 7, to mellow the heated air before coming in contact with the fruit nearest to the heater. Above this arch, within the drier, is a frame, C, for raising the racks, the ends of said frame projecting through the sides of the drier, and on the outside thereof provided with a cross-bar, D. To this cross-bar are attached wings E, for closing the openings in the sides of the drier, as the frame C moves up and down. On each side of the drier are pivoted two cam-levers, G G, for raising the frame C, which levers are connected by a rod, *a*, and a handle or bail, *b*, is attached to one lever on each side to insure uniformity in their movement. *d d* represent the racks, which rest upon each other, and are made with openings in their sides to let the heated air pass through them. *e e* are spring-catches—one in each corner—for supporting the racks after they are elevated. These catches move back while a rack is being elevated, and as soon as the rack passes they spring out and support the rack while the frame is lowered for another rack. The racks *d* do not extend to the sides of the drier, but leave a hot-air space, *h*, on two sides thereof, and in these spaces are alternately placed stops *i i*, which compel the heated air to take a zigzag course through the racks from side to side until it reaches the top. Suitable ventilators or registers are provided at top and bottom of the drier, to be adjusted to suit the necessity of the current. The fruit in the racks prevents the heated air from rising directly upward, consequently a current is formed through the racks and up the sides, as described. The radiating heat from the main current is sufficient to dry the intervening racks.

By this arrangement all the properties of the fruit, which would otherwise be lost by evaporation, are retained by the drier, fruit above absorbing that which rises from the green fruit below. The heated air as it leaves the top rack is perfectly dry, and leaves the fruit perfectly natural, except that the water has been taken out.

This drier is simple in construction, durable, and reliable, and not liable to get out of order, and easily operated.

The racks are inserted through a door, H, immediately above the frame C, one by one, and each one separately elevated by the levers G till it is held by the catches *e e*, and the next rack when it is elevated raises the first one, and so on until the racks can be taken out, one by one, at the top through the door I.

In connection with the furnace is a pointer, *x*, operated by the expansion of a rod to indicate the degree of heat.

Having thus fully described my invention, what I claim as new, and desire to secure by Letters Patent, is—

1. The spring-catches *e e*, elevating-frame C, cross-head D, and cam-levers G G, in combination, substantially as and for the purpose set forth.

2. The cross-head D, guided in slots in the house or drier, and having the wings E E, in combination, with the cam-levers G G,



L. & F. WHITTLESEY.  
FRUIT-DRIER.

No. 171,202.

Patented Dec. 14, 187

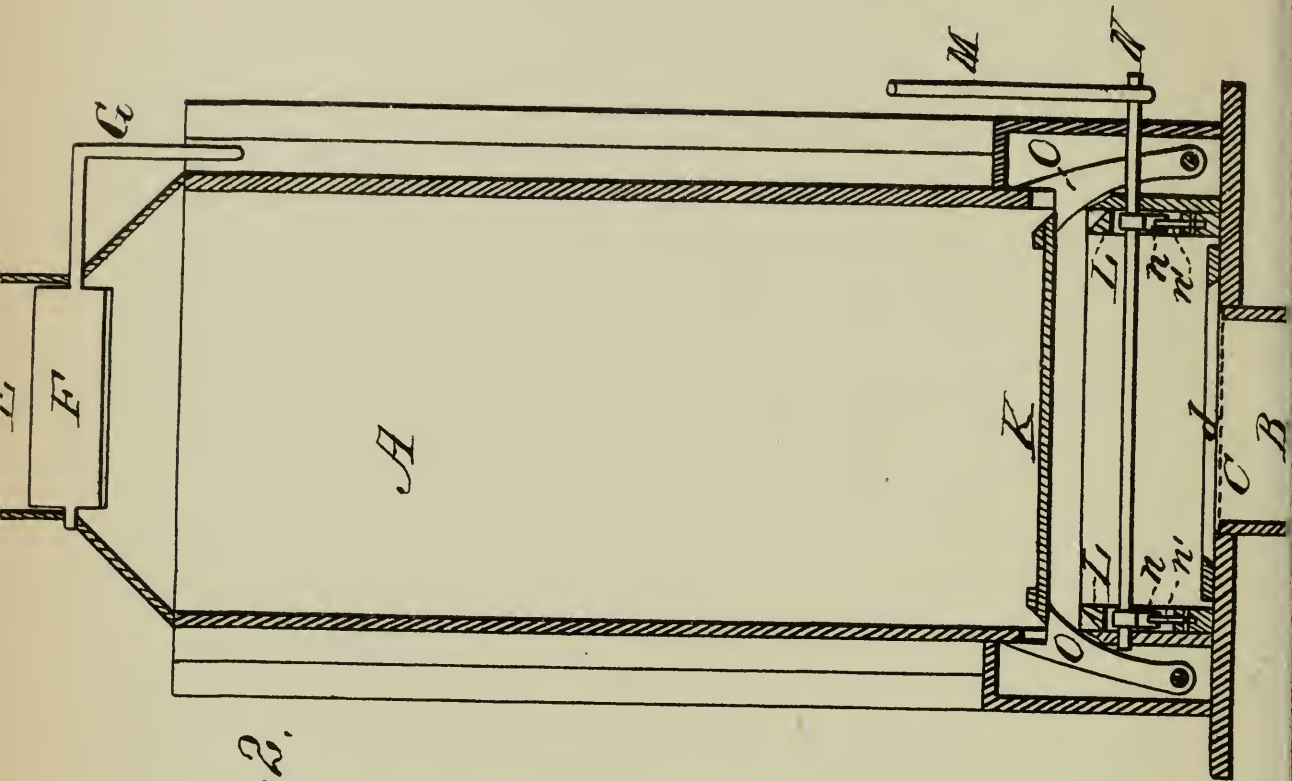

Fig. 2.

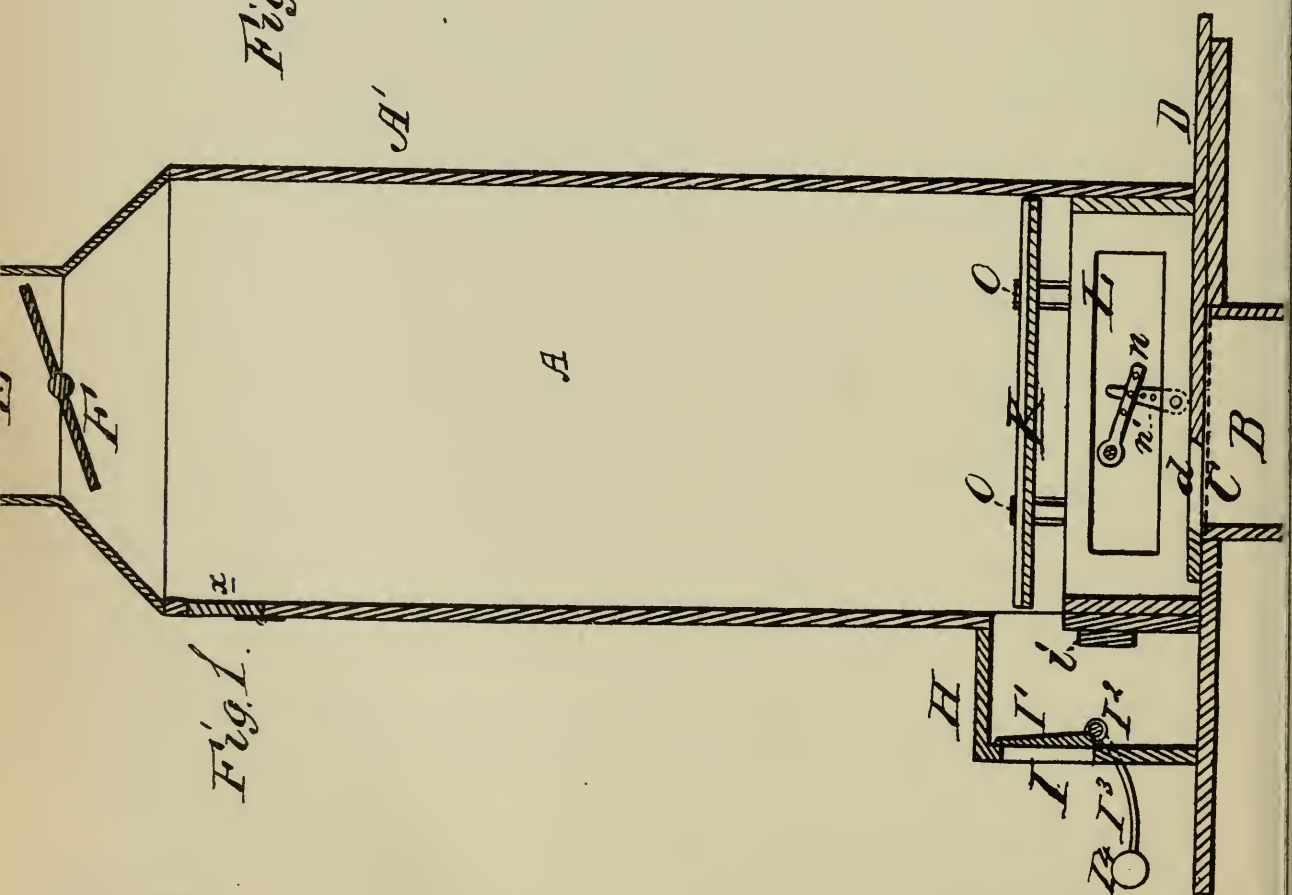

Fig. 1.

WITNESSES

*Wm. D. Patton*

INVENTORS.

*See Whittlesey*



FRUIT-DRIER.

No. 171,202.

Patented Dec. 14, 1875.

Fig. 5.

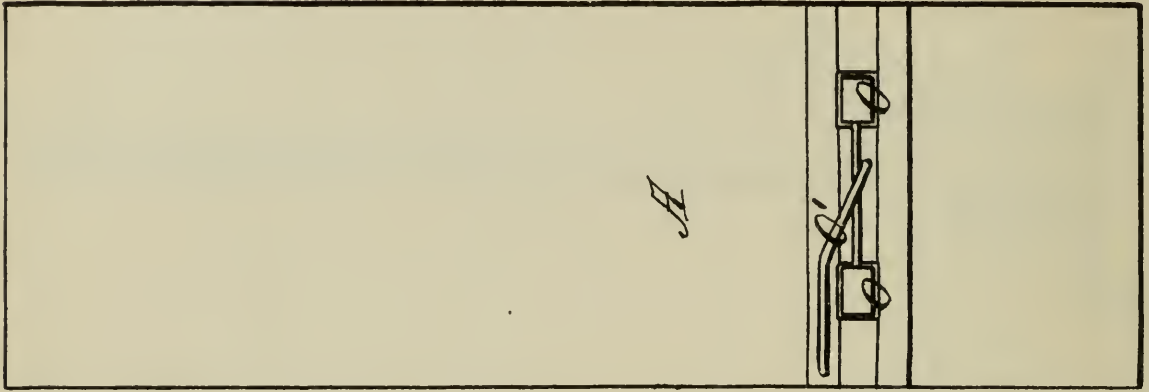

Fig. 4.

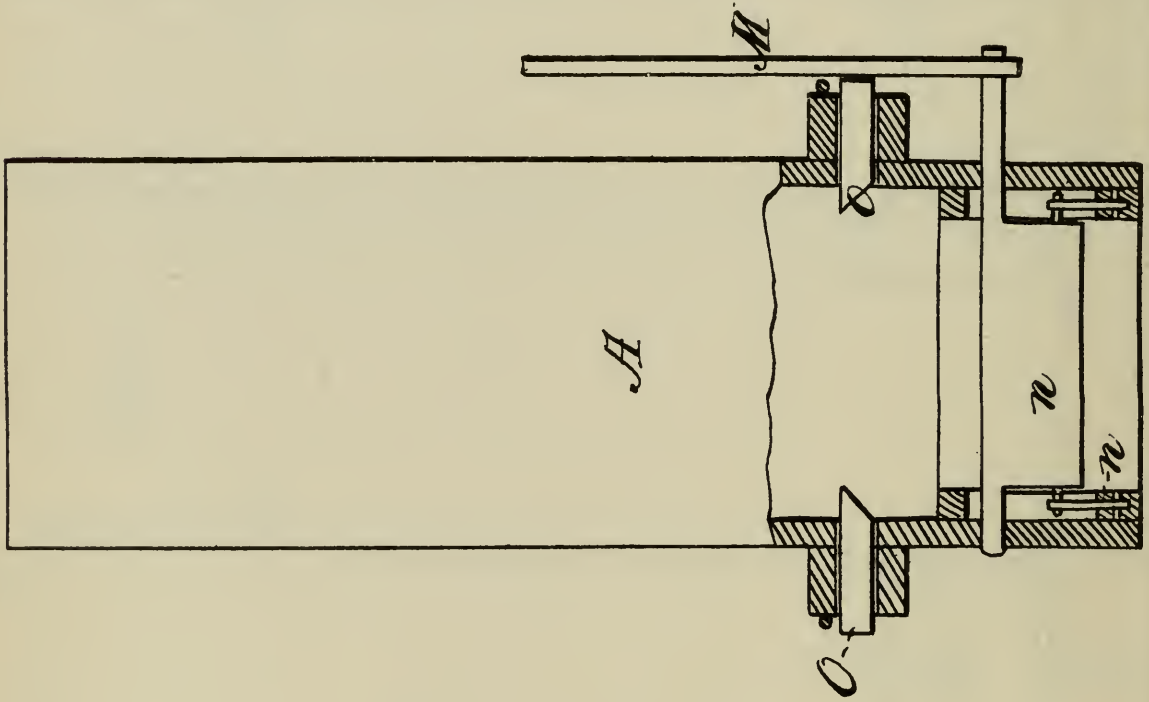

Fig. 3.



WITNESSES

*Geo. D. Patten*  
*J. H. Miller*

INVENTORS.

*See Whittelsey*

and bail or handle for operating the latter, substantially as and for the purpose set forth.

In witness that I claim the foregoing I have hereunto set my hand this 16th day of June, 1874.

J. ORLANDO BUTTON.

In presence of—

E. W. PICKETT,  
ANN R. PICKETT.

64 (The defendant here offered in evidence Letters Patent of the United States granted to L. & F. Whittlesey, dated December 14th, 1875, for a fruit dryer, numbered 171,202, of which the following is a copy:—

UNITED STATES PATENT OFFICE.

Lee Whittlesey, of Sturgis, Michigan, and Franklin Whittlesey, of Rochester, New York.

*Improvement in Fruit Driers.*

Specification forming part of Letters Patent No. 171,202, dated December 14, 1875.

Application filed November 11, 1875.

*To all whom it may concern :*

Be it known that we, LEE WHITTLESEY, of Sturgis, in the county of St. Joseph, and State of Michigan, and FRANKLIN WHITTLESEY, of Rochester, New York, have invented certain new and useful Improvements in Apparatus for Drying Fruits and other similar substances; and we do hereby declare that the following is a full, clear, and exact description thereof, which will enable others skilled in the art to which it appertains to make and use the same, reference being had to the accompanying drawings, and to the letters of reference marked thereon, which form a part of this specification.

Our invention relates to apparatus for the dessication of fruit, grain, offal, glue, or other materials or articles; and consists in a kiln and appliances, constructed and operating, as fully described hereafter, to add trays containing fresh material to the base of a column of perforated trays through which heated air or gas is passed, the trays containing the desiccated material being removed from the top of the column as others are added beneath, the whole constituting a continuous operation.

In the accompanying drawing, Figures 1 and 2 are vertical sections, at right angles to each other, of the improved apparatus; and Figs. 3 and 4 elevations, partly in section; and Fig. 5, a front view, showing a modification.

A', represents a vertical kiln or case, containing the drying-chamber A, which may be square, round, or of any other suitable form, heated air or gases being admitted to the chamber at the bottom through a grated opening, B, provided with a damper, D, and passing out at the top through a flue, E, provided with a damper, F. The material to be dried is deposited on trays K, each of which may

consist of a perforated plate, or of a frame having a perforated slat or net bottom. At the base of the kiln is an extension, H, having an opening, I, to which is adapted a door, I', the latter being hinged at its lower edge, and weighted so as to open inwardly, and close automatically. Within the lower part of the chamber A' slides a frame or carrier, L, which is connected by links  $n'$  to arms  $n$  on a rock-shaft, N, provided at the outside of the kiln with an operating-arm, M, the edges of the carrier being recessed so that it can be carried upward close to the detents O without moving the latter. The detents may be pawls, falling inward by their own weight, to afford bearings for the trays a short distance above the carrier when the latter is depressed; or, instead of pawls, spring-catches, shown in Figs. 3, 4, and 5, may be used. A tray passed into the opening I depresses the door I', and takes a position upon the top of the carrier L, the door then closing. On the shaft N being turned by its handle the carrier, with its tray, is raised, the latter, by its contact with the inclined edges of the detents O, forcing them back until the tray is in a position above the detents, which will then move inward into the notches in the carrier, and beneath the tray. The carrier is then depressed, leaving the tray resting upon the detents. A second tray, K, is passed through the opening I, like the first, and is placed upon the carrier, which is then raised until the bottom tray is above the detents, when the latter will move inward beneath the trays, supporting both. Additional trays are introduced in the same manner until there is a column of trays in the kiln, and when the upper tray is opposite the door X it is withdrawn through the same. As trays are introduced beneath, others are taken from the top with their contents in a dried condition, the operation being thus rendered continuous, and only ceasing when all the material has been dried.

It will be noticed that as the sides of the frame-carrier are notched, and the same can be raised without contact with the pawls O, the latter remain in their forward position until relieved of the weight of the column of trays, which begins to rise, by the contact of the tray upon the carrier, before the said tray begins to bear upon and move the pawls.

We claim—

1. The combination, with the kiln, of detents O, and a reciprocating carrier, having notches or recesses arranged in respect to said detents, substantially as and for the purpose set forth.

2. The combination of the carrier L, rock-shaft N, having arms connected to the carrier, and operating-arm, as specified.

3. The combination of the kiln, its extension H, opening I, and self-closing door I' hung at the lower edge, and opening inward, substantially as and for the purpose set forth.

4. The trays K, constructed, adapted to, and combined with, the carrier L and detents, as described, so as to bear against the lowest



tray of the column, and raise the latter before moving the detents, for the purpose set forth.

In testimony that we claim the foregoing as our own, we herewith affix our signatures in presence of two witnesses.

LEE WHITTLESEY.

FRANKLIN WHITTLESEY.

Witnesses :

J. H. BOSTWICK,

FRED. C. BOSTWICK.

65 MR. MILLER. That patent is dated December 14th, 1875.

Cassidy's application was filed March 8th, 1875, so that our application had been on file over eight months, at the time that this patent was granted, and therefore it cannot tend to illustrate our invention, because on the face of it our invention is ahead of his. Our invention dated from the date of its application and the file wrapper which they have offered in evidence shows the date of our application. It is not an anticipation of the patent. It was not prior to our invention or our application. Our application was long prior to that patent. How it can anticipate us even if it showed us the same thing I cannot see.

THE COURT. I shall sustain the objection.

*Fourth Exception.*

To which said ruling of the Court counsel for the defendant then and there duly excepted and hereby tenders this its bill of exceptions to the Court to sign and seal and the Court does hereby sign and seal the same.

MR. KIERCE. Does your honor hold we cannot offer this as showing anticipation and state of art?

THE COURT. As anticipation.

MR. KIERCE. We now offer it as showing the state of the art.

MR. MILLER. We object to it on the same ground.

MR. WHEATON. There is no law which authorizes the Commissioner of Patents to issue two patents for the same thing except in those instances in which he declares an interference. The law provides for an interference and provides for it in those cases.

66 THE COURT. I shall sustain the objection.

*Fifth Exception.*

To which said ruling of the Court counsel for the defendant then and there duly excepted and hereby tenders this its bill of exceptions to the Court to sign and seal and the Court does hereby sign and seal the same.

G. WIGHTMAN, called on behalf of the defendant, was sworn and testified as follows :

MR. WHEATON. Q. Where do you reside?

A. Sebastopol, Sonoma county. I have been a farmer all my life. I am acquainted with the Hunt Brothers. I have been at

work with the Button fruit dryer and have been building that drier for the last fourteen years. I have built several every year. I put up thirty-three driers this last year. I perform all the mechanical labor myself, except laying up the brick work. I hire the furnace made and the wall but the woodwork I do myself. I thoroughly understand the construction and operation of those Button dryers as described in the Button patent which has been read in evidence. I have used them ten years. I had a fruit ranch, and built a drier and used it on the place. I am still building driers. I commenced using them fourteen years ago this last summer.

MR. MILLER. Q. Are you a mechanic?

A. I am a jack of all trades. I do most anything. I never served a regular term as a mechanic. I am pretty handy at tools. I personally built all the wood work of the drier. I have read the Button patent.

Q. When did you last read it?

67 A. I sent on and got a copy of the patent in 1878. At that time I read that.

MR. WHEATON. Please explain the construction of that Button drier as described in that patent, so that the Jury will understand it.

A. I have my model here, probably I can explain it by that better.

MR. MILLER. Q. Can you explain the Button patent without a model?

A. I think I can.

Q. Then why do you not do it?

A. It is easier to explain it by the model than without. You can show the workings of it, and it does not take half as much talking to explain it with the model as it does without.

MR. WHEATON. Q. Now answer the question.

A. The model is an old one which has been made for a good many years. These represent the trays (illustrating.) The Fruit is slid in on those slides, and by taking this so it takes it up above these catches. There are catches in the post here, and here and also in the back post, with the springs on the back side. The trays pass up. It presses the spring back. As soon as the tray gets above the catch the spring comes out, then you let it back again, and it is ready to put in another tray.

It keeps working so until you get it full. There are doors here, so that you can see the fruit all the way up. You can see how your fruit is drying. When the fruit is at the top you can tell it is ready to come out. This is calculated to set on a brick wall, the same as that patent is. I believe that is all the explanation there is about it. The patent calls for throwing the heat backwards and forwards between the trays. I have never used that because I did not think it practicable.

68 A JUROR. Q. Was it intended that those trays should fit on each other?

A. Yes sir, those are three and a half inches wide. They are resting upon each other.

MR. MILLER. Q. They made then, one stack of trays, one on top of the other?

A. Yes sir. And lifted the whole column up at once, the trays slide in on this frame here, and then there is a cross piece here.

A JUROR. Q. Is that the only set of catches that is inside?

A. Yes sir. Afterwards they are carried up by the weight and set one on top of another.

MR. WHEATON. Q. Are you acquainted with the plaintiff, Mr. Cassidy?

A. Yes sir. I live about 16 miles from where he does. I have been acquainted with him for 14 years. I am not acquainted with the first driers he has built, I only know the drier he is using, I saw his large model in Petaluma. That is the only one I ever saw. I have had some talk with him with regard to the drier made by him and the driers made by me. That was 11 years ago at Petaluma. It is 14 years since I have been making the drier. I think he knew of my building the Button drier ever since I saw him at the Fair, with the model, or shortly after that. It was not a great while after that. He never brought any suits against me for infringing his patent, and never threatened anything against me.

Q. How many trays did you get in a stack in each one of the Button driers as you have built them?

A. I put 13 trays in a stack. They are two feet 8 inches square. There is a trifle difference. The sides are an inch and a quarter wide. The ends of the trays are three inches and a quarter.

Q. Does that leave a vacant space between the side boards of the trays, one of which sets on top of the other.

69 A. Yes, sir, on the side. The object of the patentee was, as I said before, to force the air backwards and forwards through the fruit. But in testing and working it, I thought it was not practicable and shut it off. In the Button drier I calculated to carry the trays of dried fruit clear to the top of the drier. The door through which I took out the trays was near the top. Where this tray is taken out, the plate of the drier is four inches, and the door is made on to that plate. After the top tray is taken out, you put in a tray below and elevate it. You can open the door along anywhere and take it out anywhere. If it gets dry before you get to the top door, you can take it out and put in another tray and elevate it. You cannot take out a tray part way between the top and bottom when they rest on top of one another. You would have to wait until you got to the top. I have seen the defendant's drier.

My recollection is that the devices in the bottom of that drier is similar to the Button. I am not positive about that. I have seen the Alden drier.

*Cross Examination.*

MR. MILLER. Q. How many Button driers did you ever build?

A. I could not swear positively; I can get pretty near to it. What I call a drier, one has three stacks, and one has two. Last year I put up 33 stacks. The year before I put up 18. I built some every year since I have been here. The stacks were 6 feet from the top of the wall, that is to the eave of the drier. From where the tray goes in at the bottom to where it is taken out at the top is 6 feet. The stacks were just wide enough so that the two foot 8 inch tray would slip in between the posts here. We  
70 put in 18 trays to a stack. The weight of one of the trays when filled with fruit depends on the kind. Peaches weigh about 20 pounds. Prunes which are the heaviest weigh from 20 to 25 pounds owing to how close you pack them.

Q. Why did you not build these stacks high, and make the trays large to put more fruit in?

A. I experimented on that. I built a two story building, and run the drier and put in 33 trays, and when I came to use the drier after I got a certain height, the fruit would be dry and ready to come out, and when it got to the top, it would not be as dry as when it was here a certain distance. We did not lift the trays up so as to get them out of the hot air, because we wanted them dry. We put the trays in on the hot air to have them dry. With so much steam from the fruit below, it would not dry off. We found it impracticable to build them any higher than 6 feet, All the ones we have built since have been six feet high.

Q. Supposing you had a stack filled with fruit, all dry and ready to be taken out, how would you proceed to take it out?

A. I commence at the top, take it out down to this door open this door and take it out to the next door and so on. We have to have a series of doors from the top down to the bottom. In the Cassidy dryer you do not, in that you can take a tray out anywhere. We cannot do that in ours, because the trays lay one on top of the other. In that respect the Button drier is different from the Cassidy drier, because the trays rest on one another. When I am using the Button drier, and get a stack full, and take out one tray at the top, I put in a fresh one at the bottom.

Q. Supposing you have dried all of your fruit, and did not want to insert any more below, what do you do then?

71 A. I would commence at the top take it out, open the next door, and take out the next and so on, down.

Q. Do you find anything like that described in the Button patent, having a system of doors, all the way down, on the side, to be opened and taken out?



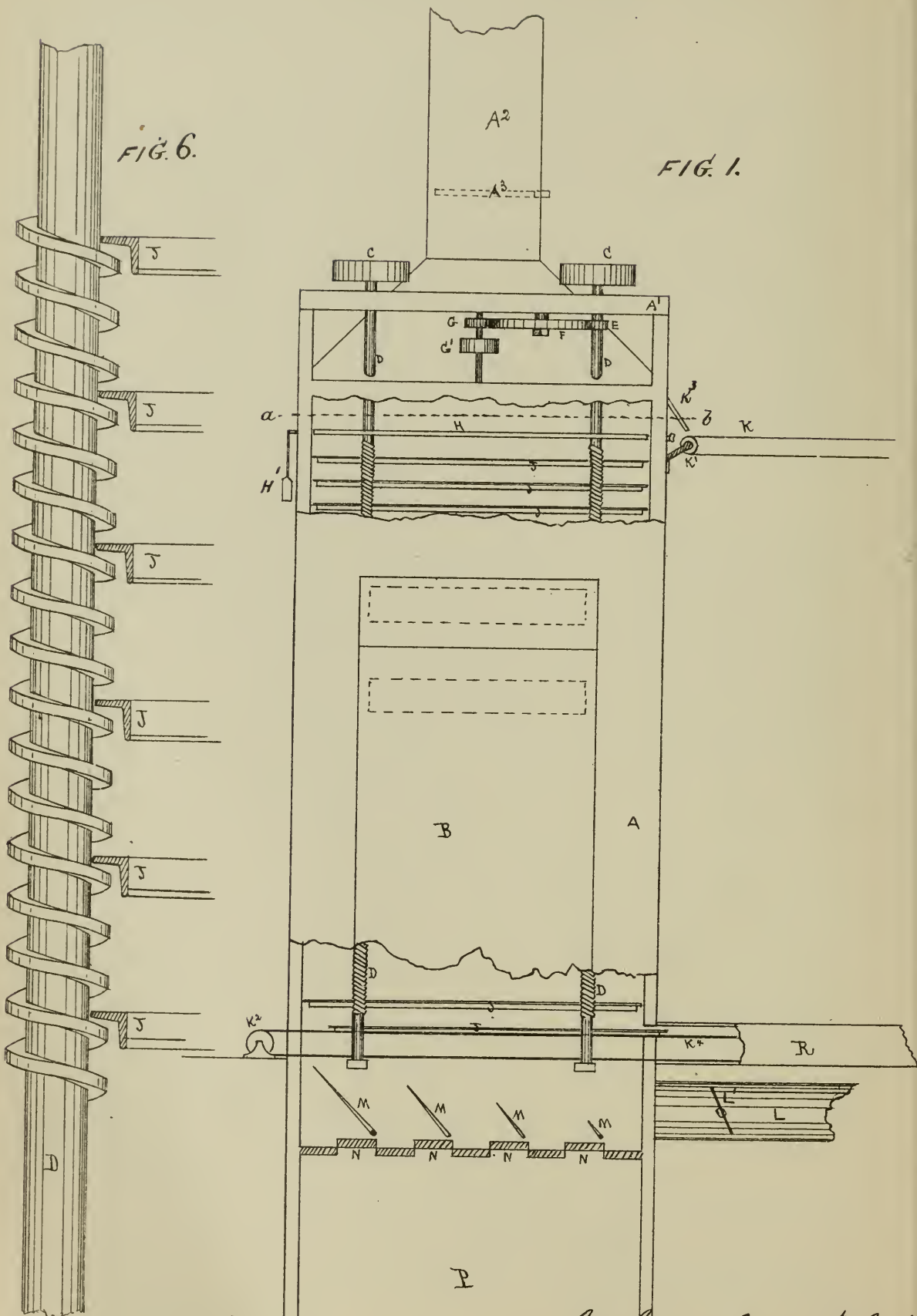

FIG. 6.

FIG. 1.

witnesses

Marshall Smith



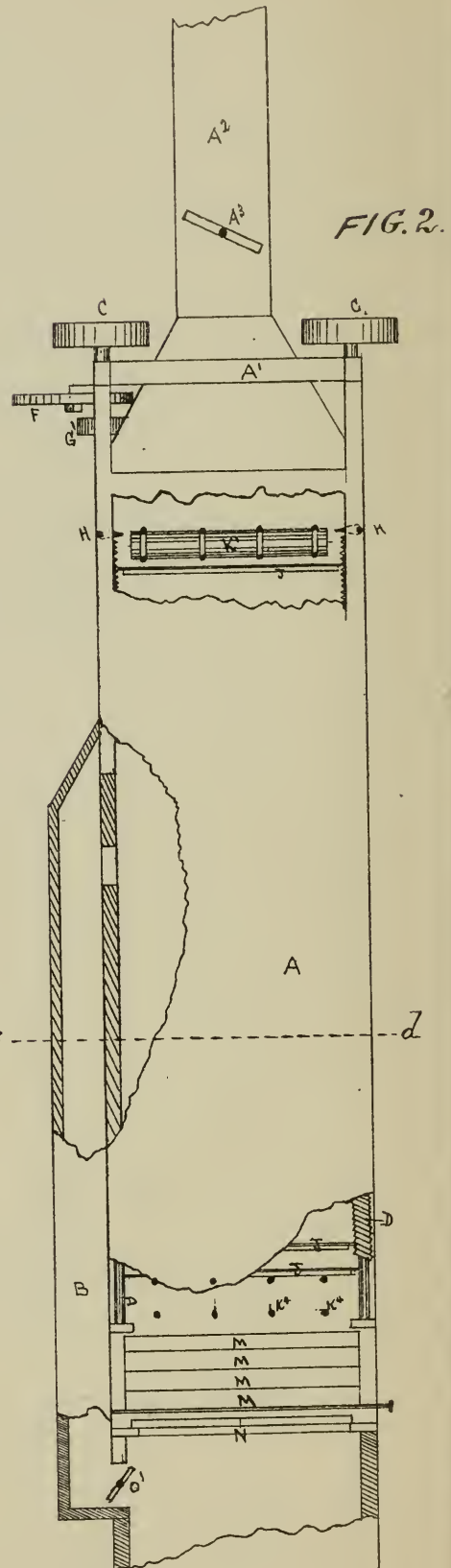
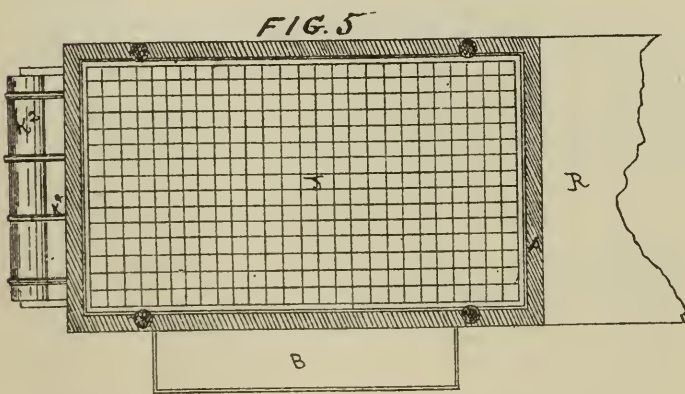
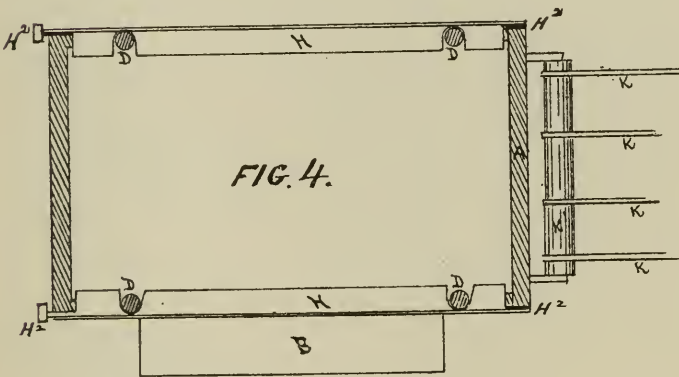
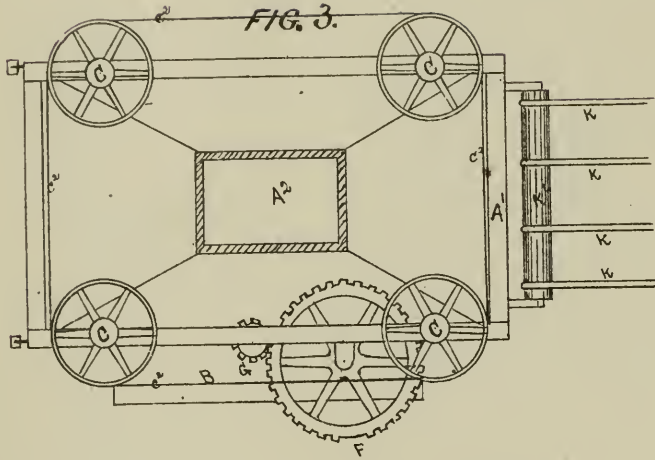

*Marshall Smith*





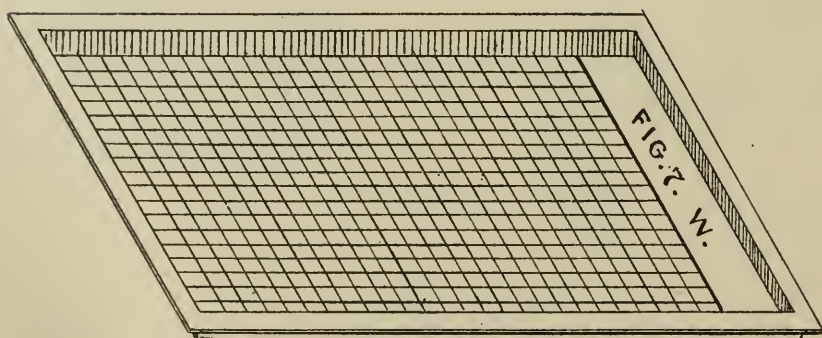
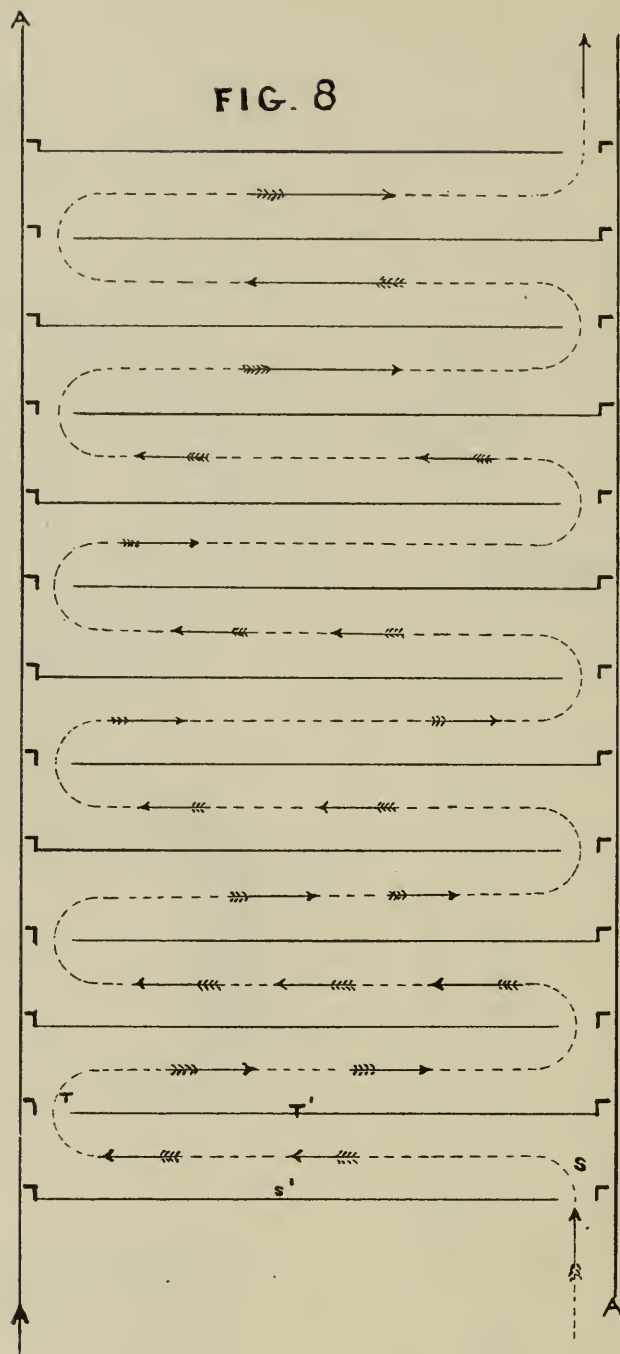

witness

Edw. J. ...

A. No sir, that is not in the patent, but I added that.

Q. That was your own idea?

A. Yes sir.

(By consent of counsel, it is stipulated and agreed that Juror Boardman shall be excused from serving on the Jury any further during this trial in consequence of the illness of his daughter, and that the trial shall proceed with 10 jurors.)

MR. MILLER. Q. Taking the Button patent as Mr. Button has described it himself, and supposing that the stack is filled with fruit, and is all dry, and you want to take it out, how would you proceed to do it according to the patent?

A. I would take out the top tray, empty it, slide in an empty tray at the bottom, slide it back, elevate it up in the same way, keep changing in that way. For every filled tray that you take from the top, you would put in an empty tray down at the bottom. I would not have to do that in this Cassidy patent. I can take out trays at any place you want to take it out, you can do so, in the way that is constructed.

(The model of the Button drier was here put in evidence and marked defendant's Exhibit No. 3.)

Defendant here introduced in evidence and read to the jury United States Letters Patent No. 107,417, granted to M. P. Smith for a drier, and dated September 13th, 1870, marked 72 defendant's Exhibit No. 4, of which the following is a copy—

UNITED STATES PATENT OFFICE.

Marshall P. Smith, of Baltimore, Maryland.

*Improvement in Driers.*

Specification forming part of Letters Patent No. 107,417, dated September 13, 1870.

I, Marshall P. Smith, of Baltimore, in the county of Baltimore and State of Maryland, have invented a new and Improved Drier; of which the following is a specification:

The first part of my invention consists of a vertical chamber or tower, in the interior of which are four vertical screws the threads of which form supports for a series of trays, which receive a rising or falling motion by the revolution of the vertical screws. The trays are made to fit the chamber as closely as possible and yet allow free motion, so that the heated air, which is introduced at the lower end of the chamber, will be caused to pass through all of the trays in succession before escaping from the top of the chamber, being thus brought into contact with all the drying substances and enabled to absorb a very large quantity of the moisture; and this is an important feature of the invention for if the warm air is permitted to escape before it has become saturated, a very great waste of heat and power is incurred. These trays I prefer to make of iron-wire cloth of as large mesh as the substance to be dried will allow; but they may be made of perforated metal or of wood. When the sub-

stance to be dried is of an open or porous nature, or in pieces of such size that the mesh or perforations in the tray can be large, the air will rise freely through the trays; but when the substance is small and lies compact, such as grain, these large open meshes cannot be used; and when liquids are to be evaporated, they must be held in pans through which the air cannot pass. I therefore make my trays with a portion of the bottom at one end removed, as shown in Fig. 7, W, and in placing the trays in the tunnel these spaces are in reversed order, as shown in Fig. 8. The heated air, entering at the bottom, passes up through the space S, over tray S', through space T, over tray T', and so on, as shown by the dotted arrow-line. The frames are made of iron or wood, and whereas the air, after passing through a considerable number of trays, will be reduced in temperature and its absorbing power weakened, a pipe or channel, B, is provided to convey fresh hot air to the upper portion of the chamber to hasten the drying. This channel may be of wood or metal, and may start from the lower chamber, as per drawing, or may branch off from the blast-pipe L.

The second part of my invention relates to the mode of entering and removing the trays by means of a combination of endless chains or ropes, K<sup>1</sup> and K<sup>2</sup> and vibrating flanges H.

The third part of my invention relates to the mode of introducing and regulating the heated air.

Figure 1 is an elevation of one side of the chamber or tower, cut away in places to exhibit the interior arrangement. Fig. 2 is an elevation of the front of the chamber, also partly cut away for same purpose. Fig. 3 is a view of the top of the chamber, showing the pulleys and gearing which rotate the screws. Fig. 4 is a section through line *a b*, showing the operation of the vibrating flanges and endless chains. Fig. 5 is a section through line *c d*. Fig. 6 shows the vertical screws in perspective and the trays in section.

Similar letters indicate corresponding parts.

A A is the frame of the chamber or tower, which may be constructed of brick, lumber or other materials. Its size will depend upon the nature of the substance to be dried, and its height should be much greater than its diameter. It should be placed in a building of three or four stories in height, to allow of easy access to the upper and lower ends, and it will be found most economical to make it twenty-five to fifty feet high and four to eight feet in diameter. A chimney, A<sup>2</sup>, with a damper, A<sup>3</sup>, is provided to increase and regulate the draft.

The lower portion of the chamber, from the ends of the screws downwards, should be placed in the cellar of the building, and in the space marked P, Fig. 1, a furnace, such as is used for heating dwellings is placed, cold air being admitted through the opening O<sup>2</sup>.

Above the furnace are valves or dampers N N, which, when fully

open give free escape to the heated air into the chamber above, and by closing regulate the quantity to any degree. L is a pipe entering the chamber above these dampers, having a valve L'.

Through this pipe heated air is forced by a fan into the chamber and, impinging on the deflector M M, is deflected upward. These deflectors are of increasing superficial area, and vibrate on journals at their lower edges, and by adjusting these, the hot air from the fan can be uniformly distributed over the whole chamber.

The hot blast and the furnaces can be used together or separately, as required, and when the blast is not used the deflectors may be dispensed with.

D, D are large vertical screws, having a long pitch and deeply-cut thread, to give sufficient hold to the edges of the trays, as shown in Fig. 6, J J. The lower ends of these screws rest in steps securely fastened to the sides of the chamber and they are also steadied by guides at suitable distances to keep them from swaying. The upper ends of these screws carry pulleys *c c*, around which passes a belt, *c<sup>2</sup>*, Fig. 3, giving them a simultaneous motion. Gearing may be substituted for these pulleys; but the power required is small, and the belt will do the work. The screws rest in journals fastened to the framing A<sup>1</sup>.

The upper part of the thread of the screw D is removed from a point about an inch below the surface of the flanges H to the end in order that the tray may be entered easily and not engage with the thread until the flange is lowered, and the lower end of the screw is also similarly reduced, in order that, when the tray reaches the end of the thread, it may drop or rest upon the carrier K<sup>4</sup> K<sup>2</sup> and be withdrawn from the chamber.

On one of the screws is a small pinion, E, engaging in a large spur-wheel, P, which also engages in pinion G on a counter shaft, which receives motion from a pulley, G'.

From the spur-wheel F one or more teeth are removed, so that, whereas the pulley G' and pinion G are in constant motion, the spur-wheel F will revolve only so far as the teeth are continuous, and when the vacant space is reached motion ceases in the vertical screws. By this device the trays can be introduced without accident while the screws are at rest, and by varying the diameter of the spur F, and consequently the number of revolutions which the screws will make before stopping, the distance between the trays may be regulated at pleasure.

The carrier K<sup>4</sup> K<sup>2</sup> is formed of ropes or chains and rollers, like the upper one, and may be extended to the packing room or elsewhere through the covered channel R.

K K are endless ropes or chains passing over roller K<sup>1</sup> close to the front of the chamber, and also over similar rollers at convenient distances from the first. These ropes receive continuous motion from pulleys not shown.

H H are flanges or bars vibrating on journals  $H^2$  which project outside of the chamber, and on one end of each flange are weights  $H^1$ , attached at right angles to the face of the flanges, which serve to keep them level until the tray is properly entered and rested upon them.

$K^3$  is a narrow door, which is raised to allow the tray to enter, and then closed.

In operation, the tray is placed upon the ropes K, which carry it into the chamber and over the flanges H, which are depressed by the weight of the tray, or by moving the weighted levers until the tray rests upon the thread of the vertical screws.

When one tray has been placed in position the spur F is moved by hand or a simple lever (not shown) far enough for the teeth to engage in pinion  $G'$ , when the screws at once revolve till F has made one full revolution and stops. Another tray is then introduced, motion communicated a second time, and so on without intermission.

Having now described my invention, what I claim as new, and desire to secure by Letters Patent, is:—

1. The arrangement of a series of trays resting in the threads of vertical screws, and receiving a falling or rising motion by the revolution of those screws in a chamber or tower supplied with a current or currents of hot air, substantially in the manner shown and described.

2. The arrangement of a series of trays or platforms receiving motion from the revolutions of vertical screws in a vertical drying-chamber, when so constructed and arranged that the current of air shall pass over each tray in succession, in the manner and for the purpose substantially as described.

3. The vibrating flanges H, when used in combination with the vertical screws, in the manner and for the purpose substantially as described.

4. The carriers K  $K^1$   $K^2$   $K^4$ , when used in combination with the vertical screws and flanges, in the manner and for the purposes substantially as described.

5. The vertical screws D, when used in combination with the vertical chamber A, for the purpose of raising or lowering trays, in the manner and for the purpose set forth.

6. The deflectors M M and dampers N N, when constructed in the manner and for the purposes substantially as described.

7. The arrangement of pinions G and  $G'$  and spur F, having one or more teeth removed, when used for the purpose of giving intermitting motion to the vertical screws, in the manner substantially as described.

MARSHALL P. SMITH.

Witnesses:

JAMES W. KIRKMAN,

W. G. BOWDOIN.

73 W. C. HUNT, called as a witness on behalf of the defendant, was sworn and testified as follows:—

MR. WHEATON. Q. Where do you reside?

A. Santa Rosa. I am Secretary of the defendant, and also one of the managers. I own a little over a quarter interest in the stock of the corporation defendant.

Q. Have you a model of the dryer that was described in this patent of Marshall P. Smith, just read?

A. Yes sir. I made the model. I am mechanic enough to make it. I understand the construction and mode of operation of the machine described in the specification and drawing of this Smith patent.

Q. Please explain the model to the Jury.

A. I made this model in a hurry. It is worked by placing the tray in at the bottom in the same manner as in the dryer that we are now using at Santa Rosa, and also Mr. Cassidy's by turning this lever, or crank, rather slowly, until it elevates it far enough, and place another tray in at the bottom, in this manner (illustrating). The devices used in here are the screws at the corners, and the chambers to hold the trays. The trays rest in the grooves on the screw between the threads. There are four screws, one located in each corner.

A JUROR. Q. Did you make those screws yourself?

A. I took them from other machines and placed them in this model. I made the model. The screws are regular, I took them from other machines and placed them in this model.

MR. WHEATON. Q. Are those screws all alike?

A. Yes sir. Each screw supports one corner of each tray. As you turn the screw the tray gradually moves upwards. When you turn the crank it revolves all of the screws at once. In that

74 machine you can remove the trays from any place you choose in the vertical movement, simply by having a door, so that it can be taken out at any place, or if there is only one tray left, it may be raised to the top and taken out at the top door. It may be taken out at the bottom or the top, for you can run the trays either up or down just as you choose. I understand the mechanical operations of the machinery that is described in the plaintiff's patent.

I have never seen any of the dryers built by Mr. Cassidy in operation. I reside 16 miles from Mr. Cassidy in the same county. I have resided there since I was born.

Q. How long have you been interested in the fruit drying business?

A. I have been interested with my brother since four years. Before that I was in the drying business with my father at home. I have never seen one of Mr. Cassidy's driers. I cannot see that the

dryer which we use possesses any advantage over the Smith dryer shown by the model.

Q. Are there any movements of the trays in the machine which you use, which are not made by the Smith dryer mentioned?

A. No sir, there is not.

A JUROR. Q. This is not the kind of dryer that you use?

A. No sir, it is not the kind we are using.

(The model was here placed in evidence, Marked Defendant's Exhibit No. 5.)

MR. WHEATON. Q. Have you a model here of the machine which you use?

A. Yes sir. The front part of this model represents the machine which the defendant is using.

75 The devices used in it are the posts with the gravity catches in corners elevating the trays. The bent lever which I have used in operating the model is exactly the same which we use in our machine. It is pivoted the same to the drier with the exception that a post runs from here up there, where we have it on outside, simply because there was not room to put it inside, that is all the difference. The mechanism which moves in that model on the front side of it and the cross heads up top are the same as used in our drier. We have another device up and down the back corners, the same as in the front. These driers were made about 5 years ago by the defendant first. I think it was in 1885 or 1886. I am not positive about that, I have no means of fixing the date when it was.

Q. In your machine what do you place the bottom tray upon?

A. Upon rollers on the outside. These are placed on the outside of the frame, and the tray rests upon that before you open the door to put the tray in. Inside there is a roller on each side, for the tray to roll on, just holding it above the cross bar. The bottom tray when put in our machine does not rest upon any side catches. The bottom part of our drier on which the tray rests is very similar to the bottom part of the Button drier. It rests upon bars, the same only I believe they are placed in the shape of a square in the Button drier, and in ours, two bars running across.

Q. Do you understand this screw and shaft mechanism shown in Mr. Cassidy's model for raising the trays?

A. No, sir, I have never examined that part of it.

Q. Please look at it, and state whether you understand it or not?

A. I think I understand that perfectly.

Q. Have you ever used any mechanism of that kind for raising your trays?

76 A. No, sir, we never have. We have never used anything except what is shown in the model just introduced. The plaintiff said nothing at all to us with regard to our having



used his invention. I showed him through the driers at one time. When he got through, he went away without saying a word about our infringing on his patent, or mentioning his patent at all. I showed him through the dryers in 1890. I am not positive about the month. I think it was in the latter part of August or first of September, but I am not sure about that. It was at the time our last dryer was built. It was just about completed. The first intimation we had that he claimed we were infringing his patent was getting letters from the lawyers, to call and settle, or they would commence suit. That was last spring sometime, I think.

*Cross Examination.*

MR. MILLER. Q. You did not settle, did you?

A. No, sir, we did not.

Q. Have you ever seen a Smith dryer?

A. No sir. I got my knowledge about a Smith dryer from reading the patent. I read it about a week ago, and I have read it since that time. I constructed this model which correctly represents the Smith dryer from the patent if it is worth anything. I have read the patent, seen the drawings, the patent does not say how the trays are constructed, only, that they are constructed of wire cloth, I suppose there is some wood about them, but it does not say so. As near as I can tell from the drawings of the patent they are constructed from wire cloth, with a frame of wood around them. They are not exactly like the construction of our  
77 trays. They differ in this that there is no cross wire shown, crossing their tray diagonally as they are in ours. They are constructed with a flange the object of which is to rest in the groove of the screw. That construction of tray is necessary with that kind of device. Without it the wood would be too wearing in the grooves. It would wear the wood out in a short time, and you would have to put on iron. These flanges are supposed to be made of metal, I believe. There would be considerable wear between the wearing of the trays and the screw. These screws can be made any length. They can be made any size, to suit the size of the drier. The patent does not state the size. It simply states that they are generally placed in a three story building, which is not necessary. It can be placed in a one story building just as well. They have machines that can cut those screws perfectly even without any difficulty. I think it would be a simple thing to cut them. I never cut any, that is my judgment. I have known of the Smith patent for about a week. My knowledge of it is gathered from what I found of it during the week. I have known of the Button patent a number of years. I don't know exactly how long, we had one in use part of the time. That was three summers ago. It is standing there yet. It belonged to a party named Mr. Roberts. We rented it because we had more fruit than we could put through

our own driers. We do not rent it now.

Q. You say that you do not see that your driers had any advantage over this Smith drier constructed with those screws, is that a fact?

A. Yes sir. The reason why we don't use the Smith driers is because we did not know of it at the time we built ours. I know the patent has expired, and that we have a perfect right to use it if we see fit. We never used it.

78 There are seven other parties connected with the firm besides myself, they are J. H. Hunt, Mr. Curtis, L. W. Burris, M. J. Stranning, Charles W. Pike, E. C. Merry, R. W. Hawes and Paul Hunt. My father is not connected with the concern, he does not own any stock in it, and never has had any. He is running drying himself at Sebastopol, about 8 miles from our place.

MR. MILLER. Q. Who built your driers?

A. A man of the name of Folger did the woodwork, and some of the iron work was done in San Francisco. In fact they had 25 men working on it at one time. I planned the driers, from driers I had seen before, from one my father built. I planned them from the one we had before that. The first drier, I did not build. The drier that we are speaking of now, we commenced building last year.

Q. Please fix the date when Mr. Cassidy came up there, and you showed him through the establishment?

A. The exact date I don't remember, it was in the year 1890. I fix that from the fact that it was our first canning year in Santa Rosa, and Mr. Cassidy had sold us some fruit and was up there. Whether he came to settle that day or not I don't remember. Any way I took Mr. Cassidy and showed him through the cannery and through the dryers also, as a fact. I heard Mr. Cassidy testify that he did not remember my being there. He said he did not see either one of us. At the time he is speaking of, he may have gone through without us but I showed him through the dryers once, I remember that quite distinctly. That was a year ago last summer, I should say.

*Re-Direct Examination.*

79 MR. WHEATON. Q. You have testified to the Button patent. What is the difference in the operation between the Button machine and your machine, as to raising the trays?

A. In the first movement I do not see any material difference. After the first movement the Button patent rests one tray on the sides of the other, while in ours each tray rests on separate brackets or gravity catches.

Q. Does every tray have a support which carries it to the top of the drier?

A. Not a separate support in the Button drier. It has a support. The reason that it has no separate support in the Button patent is

because one tray rests on the sides of the tray below, the weight of all the trays resting on the catches at the bottom. That makes a separate support for each tray, but at the same time each tray would be carrying the weight of all the trays above.

Q. What material difference does it make in the operation of the machine, whether the trays are carried up one above the other or supported and carried up by these catches?

A. The only thing is it is a little convenient in taking out the tray at any point.

Q. What prevents the devices that are used in one machine for carrying up the trays from being an equivalent of the devices that are used in the other machine for carrying up the trays?

A. They are equivalent I think. Both accomplish the same thing by different operations.

Q. What difficulty, if any, have you experienced with the gravity catches in practical use?

A. They often gum and fail to drop out, letting the trays often come down at one corner, and as each tray passes a bracket, that is caught, and finally all the trays are standing on one edge  
80 and spilling the fruit.

That has happened in my stacks many times. I don't know whether or not it would happen if I had spring catches. I have never used a spring catch. It could not very well happen to the Button drier, unless the bottom catch should happen to drop.

If it did it would happen in the Button drier. The gumming is liable to take place at almost any point; the bottom will be worse than nearer the top.

Our stacks are built to hold 36 trays. That makes them between ten and twelve feet high. Our trays are three feet and a half square. We get rid of the condensed moisture at the upper end of the stacks by creating a draft, through each stack, by turning cold air in at the bottom, and allowing the hot air to pass out at the top. There is considerable draft through our drier. The more draft you can get without having too much the better it is. If the draft were entirely stopped, the moisture in the upper part of the stacks would condense considerably. So that the fruit would go through a sweat instead of drying. It would cook the fruit and not dry it. It would leave the fruit all soft and mushy.

MR. MILLER. Q. You stated in your judgment the device for raising the trays in the Button patent was the equivalent of the device used in your drier?

A. Yes sir.

Q. The device used in the Button patent consists in four spring catches at the bottom of the stack, does it not?

A. They have a catch with a spring back of them, I believe.

Q. As the tray comes up the spring goes into the groove  
81 and allows the tray to pass. When the tray gets above, the

spring comes back to its former position and rests on the spring?

A. No sir, it rests on a gravity bracket with a spring behind it so that if it should catch it would throw it out. I mean in the Button device. In my judgment a spring catch is a mechanical equivalent for a gravity catch. The gravity catches used in my machine are the mechanical equivalents for the spring catches used in the Cassidy machine. We have not used the Button patent because we thought it was better to have it continue by each tray resting on separate rests, instead of every tray, on every one below it, it is only a matter of opinion why it is better. That is the arrangement shown in the Cassidy patent.

A JUROR. Q. You speak of those equivalents of Button and your drier for raising. I should like to ask you if there is not something in connection with the weight, that is on the lever you have to raise, if you have the Button patent. You would have a pretty heavy weight?

A. It would be exactly the same as ours at present.

Q. You would have the weight of all the trays resting on that lever as you put them up?

A. We have on this one too. The lever raises the bar the full height of your dryer.

Q. What bar?

A. The sliding bar.

Q. I do not think you explained that to us fully?

A. I can do that.

Q. I did not so understand?

A. The weight of this bar, and the weight here on the top, comes on this here (pointing).

82 Q. You have not those movable posts represented in the Cassidy machine?

A. These are what they claim are the movable posts (pointing). The weight on the bottom and the weight on the top would be exactly the same on the lever.

It would not make any difference whether the weight was on the bottom or on the top.

MR. MILLER. Q. In this device of yours you have four movable posts, one at each corner?

A. Not exactly posts. They are iron. The same thing as posts. They have a series of gravity catches from the top to the bottom. They have also four stationary posts besides the movable posts. These also have gravity catches arranged in them. We have a drying chamber. This model here is supposed to be enclosed—it is left open to show the working better.

We have in combination with the drying chamber the movable posts provided with catches and stationary posts provided with catches and the mechanism for lifting them.

MR. WHEATON. Q. Is it not true also that in the dryer made by Cassidy the whole weight of the trays, every time that he lifts them, comes upon his lower catches in the lifting?

A. They do not come on the catches themselves. They come on the sliding posts. The weight of all the trays is on the sliding posts, whether near the top or bottom.

Q. Does not the weight of those four sliding posts, every tray carried by those sliding posts, come upon his lower catch, when he lifts them?

A. No sir, they do not come on the lower catch. They rest on the catches on the sliding posts.

Q. What lifts the sliding posts?

A. The same as this would be lifted by the lever. Instead  
83 of all of them coming on the bottom piece, they would come on the post, but the weight would come further up, on a separate catch.

Q. In that respect there is a difference between the machines that you use and the machines built by Mr. Cassidy?

A. In ours simply the weight of the tray rests upon the catches the same as theirs. The weight of that we spoke of a while ago is all on the lever, but in the posts the weight may be distributed from the bottom to the top. You may have a tray resting on top and all the weight is on the catch instead of the catches on the bottom. The weight of the whole machine and all the fruit is on the lever.

Q. You put your bottom tray on the table or on the rollers?

A. On the rollers. On the bottom there is no catch at all. It is simply a cross bar until it raises above the first catch. Then from there up there are catches. I think in Mr. Cassidy's machine he has a catch on the bottom. It is a stationary pin. It is a stationary lug for the trays to rest upon.

Q. In each movement upwards of the trays does he not have to have the entire weight of the trays and the sliding posts rest upon the device that lifts them up?

A. Certainly, it all rests upon a device for lifting. They all have to be lifted with one device. The entire weight, whatever is lifted, has to come upon that device which lifts it.

MR. MILLER. Q. In that respect it is just the same as yours?

A. No sir, it is not. In ours the weight is lifted here. The means for lifting them is different. So far as the distribution of the load is concerned it is just the same.

84 C. WIGHTMAN re-called upon behalf of the defendant testified as follows:

MR. WHEATON. Q. What if any thing did Mr. Cassidy say to you about bringing suit?

MR. MILLER. I object to the question as irrelevant, immaterial and incompetent.

THE COURT. What do you wish to prove?

MR. WHEATON. I wish to prove that Mr. Cassidy came to him and requested him to join Mr. Cassidy in bring suit, saying in effect that he could not do anything alone because the Button patent was ahead of his and the suit would have to be brought on both patents, showing an admission on his part that the Button invention was ahead of his own. They have proved by Mr. Cassidy that his invention was ahead of the date of the Button patent. I want to show by Mr. Cassidy's statements that he did not consider that his invention was ahead of the Button invention.

MR. MILLER. I think that it would be wholly immaterial. Here is the Button patent and the Cassidy patent. It is for the Court to say what they are for. Any notion that the parties might have had, or any proposition that Mr. Cassidy might have made to join with any one else to combine their forces would cut no figure at all. I do not think that is relevant.

MR. WHEATON. I think that it is material in another respect. It is a direct admission on his part that his machine was an infringement of the Button patent.

THE COURT. Read the question in regard to that.

THE REPORTER. (Reading) "What if any thing, did Mr. Cassidy ever say to you about bringing suits"—

MR. WHEATON. Or about your joining him in bringing a  
85 suit?

MR. MILLER. I make the same objection to that.

THE COURT. If you want any conversation as to the dates as to the application for the patent, or any thing of that kind, you can ask that. That probably will be material.

MR. WHEATON. Do I understand your Honor to rule it out?

THE COURT. It seems to me that it is immaterial. I do not think that the fact that he asked him to join him in a suit would cut any figure in this case.

*Exception No. 6.*

To which said ruling of the Court counsel for the defendant then and there duly excepted and hereby tenders this its bill of exceptions to the Court to sign and seal and the Court does hereby sign and seal the same.

MR. WHEATON. Q. What, if any thing did Mr. Cassidy say to you with reference to the Button patent being ahead of his own?

A. He did not say it was ahead. He said he could not do anything without I would join him. We were talking about a drier that came out that was an infringement on his and the Button drier also. I suppose his idea was to get me to join with him to prosecute. It was the Champion drier. Mr. Hoig had the patent. He suggested to me to join to prosecute Hoig. He said there was \$50,000 in it. I asked Mr. Cassidy the question: If you prosecute him and get judgment, where will you get your money? He said he thought he could get it without any trouble. I told him I knew

he could not.

THE COURT. I think we are going outside. I do, not want to shut out anything that is proper though.

86 MR. WHEATON. Q. Did Mr. Cassidy say anything in regard to his infringement on the Button patent himself?

A. No sir. He did not say to me that it was an infringement on the Button patent. He said that all the patents issued were an infringement on him. When I was first talking to Mr. Cassidy as I said before, was when I saw him in Petaluma and he had a large drier there, the same size as the drier he uses, about three foot square, and we were talking about it. He went on to explain the drier and also said that his was the first patent except the Smith patent. I spoke to Mr. Cassidy at the time and said I always thought that Alden's patent was the first patent. I think he said that it was the Smith patent. He said that all patents that were issued after that were an infringement on his drier and he was going to prosecute them.

JOSEPH H. HUNT was called on behalf of the defendant, was sworn and testified as follows:

MR. WHEATON. Where do you reside?

A. Santa Rosa. My age is 27. I am president of the corporation defendant in this case and also one of the managers. I hold individually about one-third of the stock of that corporation. I am a brother of the Mr. Hunt that was a witness yesterday. That corporation was formed April 10, 1890.

Q. When, if ever, did you know of one of the Alden fruit driers?

MR. MILLER. I object to the question as irrelevant, immaterial and incompetent. We have received no notice of Alden as an anticipation if it is offered as an anticipation.

87 MR. WHEATON. I do not suppose the Alden is an anticipation. It did not have spring catches, but we offer it to show the state of the art. We claim that it was so near what was patented that the difference between what was patented was so little as to invalidate the patent. We do not offer it as an anticipation.

THE COURT. I will allow the question.

A. Since 1876. I first saw one operated on my father's ranch near Sebastapol in Sonoma County. I did not have anything to do with building it. I had full charge of it for three seasons. I never saw one of the driers built by Mr. Cassidy. I have read the specifications of Mr. Cassidy's patent and understand how it is constructed as well as could be learned from the specifications of the patent and looking at the model.

I have never examined the model closely but I think I understand the workings of it thoroughly.

Q. Please look at the specifications of Mr. Cassidy's patent, and

state what means are described there for operating or moving up and down the vertical sliding posts. It says "The movable posts L may be elevated and depressed in many ways, as by cams, eccentrics, etc., but in the present case I have employed a central roller O, with a crank at one end. Upon this roller cords or chains P, are coiled." Do you understand that part of the description of the specifications?

A. I think I do. I do not see anything described as that is in the model of Mr. Cassidy's drier, for raising and lowering the posts. I do not see in it anything that corresponds to the roller O, in the crank mentioned in the patent, nor any devices there that winds up cords. Nor any cords attached to the bottom of the posts that raise them. I do not find described in this patent  
88 any of their gearing as shown in that model for raising the posts. There is nothing that applies to this gearing at all.

Q. When did the defendant corporation first build any driers?

A. In 1890. We built what we term two driers.

That is six stacks over each furnace, what Mr. Cassidy would term 12 driers—12 stacks. Six of them over each furnace, making 12 stacks in all. The corporation since it was formed has never built any other driers. I built one myself prior to the time that we incorporated. That is now owned by the corporation. One drier with six stacks. These three furnaces and those 18 stacks include all the driers that the defendant has been in possession of or used.

Q. Do you know how your father came to build the Alden drier in the first instance?

A. He bought the patent in 1876, and put in an Alden drier. He bought the right to use it, to build driers that he built. I don't know if he bought any state rights or not, I don't think he did. I think he just bought the right to use what he put in. At the time I built my drier, and the defendant when it built its drier, had full right from my father to use the Alden.

MR. WHEATON. We have not the Alden patent here, but I have the patent office reports of 1870. The Gazette was not then issued. I offer the record of that merely for the purpose of showing the date and also what the claims were, the date of the Alden patent.

89 (The evidence here offered consisted of a portion of page 196 of a certain book entitled as follows:—"Annual Report of the Commissioner of Patents for the year 1870. Volume 2. Washington Government Printing Office, 1872.")

Without any further authentication or proof of publication and read as follows:—100,835 Apparatus for drying and evaporating. Charles Alden, Newburgh, N. Y.



The said claims therein set forth being as follows :

CLAIM—1. The arrangement of a series of platform, attached to endless chain, and receiving a rising or falling motion in a trunk or chamber, supplied with a current or currents of hot or cold air, substantially in the manner shown and described.

2. The arrangement of an air chamber on one or more sides of the trunk, said air chambers being provided with nozzles to throw currents of air over or between the platforms, substantially as set forth.

3. The arrangement of fingers projecting from endless chains, and capable of supporting the platforms during their rise or fall, and of depositing the same automatically at the bottom of the trunk, substantially as described.

4. The arrangement of a conveyer, substantially as described, in combination with the platform and with the endless chains and their fingers, so as to remove said platform from the bottom of the trunk.

MR. MILLER. I object to it, it is not a competent record. This is a patent office report which contains the claims of the patent and the drawing of the patent. It is not the patent and it is not the specifications of the patent and does not contain the specifications of the patent.

90 THE COURT. You have already shown the existence of that patent. Therefore it will be immaterial what the date is. I doubt if that book is admissible in evidence for any purpose. It does not seem to me that it is.

MR. WHEATON. The ultimate object is to show when that patent expired and to show when that became public property.

MR. MILLER. I object to it because the book is not competent evidence of any thing.

MR. WHEATON. Any book that has the description of a patented device is competent evidence if it is anterior to the plaintiff's patent.

THE COURT. What is that your book which you have there?

A. It is the official reports issued by the patent office itself.

MR. MILLER. That is, it purports to be that.

MR. WHEATON. It is that.

MR. MILLER. Where is the evidence of that?

MR. WHEATON. I will swear Mr. Miller and he will swear to it?

MR. MILLER. I will not swear to any thing of the kind; it is a common, ordinary patent office report, containing the claim and drawing.

MR. WHEATON. I said I could prove it by Mr. Miller.

THE COURT. I do not see it cuts any special figure.

MR. WHEATON. I will state to your Honor what I am driving at. The parties have shown something in the nature of a royalty collected way back of the time before this patent expired. When this patent expired every one could build the Alden furnace

91 and then although the Alden furnace was covered by a patent prior to that date, and the public could not use it, the very fact of that expiring may be the reason why he could not sell another royalty, because the public had a better drier than his which had become public property.

THE COURT. I do not think that book is admissable in evidence.

MR. WHEATON. Does your Honor rule it out?

THE COURT. Yes.

*Exception No. 7.*

To which said ruling of the Court counsel for the defendant then and there duly excepted and hereby tenders this its bill of exceptions to the Court to sign and seal and the Court does hereby sign and seal the same.

MR. WHEATON. Did you hear Mr. Cassidy's testimony as to when he was at the defendant's factory and saw their driers?

A. I did. I know the exact date by our books. It was June 23, 1890. The driers were in mode of construction. We had just commenced to put in the machinery. Had enough in to show the workings of it, but it was not completed. I saw my brother start through the cannery with Mr. Cassidy, showing through the factory where they were at work. I had no conversation with him about those driers until the suit was threatened. First intimation I had that he had a drier any thing like ours was getting a letter from his attorneys to say that unless we settled he would bring suit.

Q. What was the cost of building the driers which defendant used?

92 A. I have not the exact cost of the drier built in 1887 by myself. Those built in 1890 representing twelve stacks of the eighteen that we now own cost \$6740.59, with the complete building and apparatus. The building is 66 by 80 feet. The stacks are built right along one beside the other twelve inches apart. The furnace and pipe run back and forth the full length of it.

Q. What was the cost of each one of those furnaces with each set of three stacks belonging to it?

A. Within a few dollars of two thousand dollars apiece. \$4000.00 for the twelve stacks including just the brick work and driers, aside from the building. I dont know that this is exact. The cost does not vary a great way from \$300. for each stack. I could not swear positively. I think it was over \$300. I know that was estimated as what it would be,—\$300. apiece and it cost a little above what our estimate was. That is my impression.

Q. Can you state positively whether it was over \$250. for each stack or not?

A. Yes sir. It was over \$250.

Q. How does the operation of your drier compare with that of

the Alden drier which your father built and you used?

A. There is a very slight difference in raising the trays. In the Alden drier the brackets were on endless chains going up on the inside of the drier and down on the outside. As the chains come in under the wheel of the bottom the brackets drop out. As the chain goes out at the top of the drier the brackets drop down to allow it to come down in a compact space and suitable gearings for raising those four chains at one time. As they are raised up these brackets sticking out at each chain in the four corners carry the chain up. In moving them up one notch a tray is put in and then another notch and so on until the drier is full. Then  
93 the operation of taking off the dried fruit at the top and putting in the green fruit at the bottom continues. It is the same way with our drier instead of using the endless chains we cut it in two and put both pieces on the inside. It was originally an endless chain, but we cut it in two. One piece worked up and down in each corner, while the other four were stationary, using the same Alden chains that we had in the old Alden.

Q. Look at the wooden model which I now show you and state how nearly it represents the Alden chain which you now use?

A. It is as near exact as is practical to make it, with the exception of one or two very slight things. The only difference is this bracket over the double bar, instead of being riveted on the outside is riveted on the inside between the two bars. The bracket riveted on the single link is the same here. They project out in that manner. We had two, one along side of the other. One of them worked up a notch and brought the tray up until it would pass up and down above, like that.

On the stationary one, as that would drop down the chain that works up was allowed to go back in this manner, and this would drop out there (pointing). That is the next bracket above would drop out below that tray. In bringing it up again it would bring it up past the next bracket on a stationary chain. That was simply making a little change in the Alden drier whereby instead of using endless chains going around, we put the chain in two pieces in each corner and worked one up and down while the other was stationary. That change was made I think about 1883, in my father's drier. I forget the exact year. All the difference now  
94 between that and our present means of raising is, instead of having one single link, and one double link we take two bars of iron and riveted the single link in between all the way up, and have it solid instead of being jointed. Putting the bracket in between, and a pivot in here to keep it from falling over. As one worked up past the others it would drop back. The same means of raising it, with the exception that instead of having link chains like this, we had two straight up and down bars with these brackets riveted between them. That is the difference be-

tween the drier and the Alden drier that was originally used by my father.

(The said model was here introduced in evidence and marked Defendant's Exhibit 7.)

Q. Have the defendants used any vertical movable posts in their machinery other than the two straps of iron with these catches between them, as you have thus described?

A. No, sir, they have not.

Q. Please look at the movable posts in plaintiff's Exhibit 3 and state whether the defendant has used posts of that description or not.

A. No, sir, they have not. All the posts that we have used are those two bars of iron with the catches riveted between them.

Q. Are these two bars of iron with the catches between them used on each side of one of the defendant's stacks lifted from the bottom or are they suspended from the top?

A. Fastened at both ends. They have cross supports at the top and also at the bottom. They are built solid all in one frame.

Q. All move together?

A. Yes, sir. The four move by one means and the four stationary ones are bolted to the wood work of the drier.

95 Q. What name, if any, do you sell your dried fruit under?

A. Hunt's Improved Alden is the brand that we are using. We originally used the Alden. We have a reputation for the Alden brand of goods. When my father made the change, while the fruit was no better, and there was really no change in the process he called it the improved Alden. Simply the improvement instead of using the endless chains he uses the two pieces inside, one working up and down and the other stationary. Since that, we have branded the fruit "Hunt's Improved Alden." The Alden is the prominent word in the brand. That is the brand that we have the reputation for.

In the Alden dryer the mechanism for moving the chains which lifted the trays was a gearing by means of cog wheels. There was a shaft that went across the top. I am describing the patented Alden dryer.

Q. What mechanism was used in the Alden dryer which your father first built for moving the chains which lifted the trays?

A. Simply a lever, the same as represented in this model. The chains were supported by means of cross irons at the top. They were rivited to that. It was all made in one cage. As the lever was pulled down, it threw this cage up, and moved all four of the chains up together on the inside. As the handles were let back, it dropped down below the next tray again the same precisely as this model of our dryer. (Pointing to Defendant's Exhibit 6.) The endless chain was cut in two. It was not the endless chain when it slid up and down inside. My father first built the Alden dryer, running with

the endless chain. The mechanism for moving those chains were a shaft with cog wheels on that, and the cog wheel went  
96 through the dryer and the chain went over some wheels.

By turning a crank thus (illustrating) it turned those cog wheels, and wound the chains up on the inside, so that those two shafts turned in opposite directions, rolling the chains up on the inside and down on the outside. That was done by means of a crank similar to the one of the plaintiff's by screws. The mechanism was almost identically the same with that which is in the plaintiff's model Exhibit No. 2, except the Alden dryer turned always the same way, while this turns up the same way as the Alden dryer until the tray raised one notch and then moves back. The Alden moved exactly the same way except that it rolled up on the inside; both moved up. The mechanism was the same in both. In one case it was used by turning it always in one direction, and in the other by turning it in one direction and then back again.

I am acquainted with the Button dryers that were built by Mr. Wightman the witness, have seen a good many of them. Have seen them at several different ranches at Sebastopol, and at Santa Rosa. They are the most popular dryer now in use in Sonoma county; there are more of them in use I presume than perhaps all others put together.

*Cross Examination.*

MR. MILLER. Q. You say your father bought an interest in the Alden patent and built an Alden dryer in 1876, and you assisted in building it?

A. I did not say I assisted him in building it. I assisted him in running it. I worked on it two or three years, I forget whether it was two or three years. That is the one that had the endless chains which went up on the inside and down on the outside.  
97 The next one father built was the one that he has now, built I think in 1883.

That is the same as the other with the exception that he uses the chains, but half on the inside, instead of using the endless chains. He cut the chains in two. He dispensed with the feature of the Alden dryer consisting of the endless chains. I don't know why he did it.

Q. Are you not sufficiently versed in the art of fruit drying to know why he did it?

A. I have been at it for sixteen years. I know more or less about the business but why he did things eight or ten years ago, I don't know.

Q. Did it improve the dryer?

A. Yes sir. I guess it was an improvement. It was an improvement on the old Alden dryer mainly because it allowed you to have less trays in a stack. If you have too many trays of fruit one above the other the fruit will become dry, and the moisture from

the bottom trays will be absorbed in the dried fruit at the top, and it will become damp, what we call sweating. It is very hard to get a draft of hot air through a tall chamber of fruit. My father still kept the chain but cut it in two. He kept it as a flexible chain. One ran up, the other was stationary.

The one that ran up was not on a movable post. There was no post above it. The chain was riveted to a bar of iron at the top and another at the bottom; a frame work was on the outside of the dryer, that supported the two cross bars, one at the top and the other at the bottom. He built one dryer with five stacks in it, which are the ones he now has, except as I said he has taken the link chain out and put in the two solid bars of iron through to the top.

98 I don't know when he did that. It is some time since the dryer was built. That does not improve the dryer any. It lifts the trays the same exactly. It is a mere matter of preference as far as I can see. He changed from the flexible to the solid chain. We have a solid bar in ours. In that respect my father's and ours are identical.

Q. In your judgment is that a better way than having a flexible chain?

A. I don't think it is. It may be better in some ways. It is a mere matter of opinion whether it gives a better result or any cheaper.

Q. What is your opinion?

A. My opinion is if I had to do it over again I would use the flexible chain. We learn these things by experience.

We didn't use the flexible chain when we built our dryer because we did not know any thing but what my father built.

We were too new to the business. We took any thing he had and put it up, patterned after it exactly.

Q. Copied after your father's dryer?

A. Yes sir.

Q. You had a right to build the Alden dryer, if you wanted to?

A. I suppose we had. We had a right to build what we did build.

Q. Why did you not build an Alden dryer?

A. Because I did not know how.

Q. You had seen them?

A. Yes sir.

Q. Had you seen any dryer like the one you did build, before you built it?

A. Only the one my father has.

Q. You had seen the one your father had, and seen an Alden dryer?

A. Yes sir.

99 Q. So that you knew how to build one as well as the other?

A. No sir.

Q. You did not know how to build the Alden dryer?

A. I did not know how to build either one, without taking the irons off the dryer and patterning after them.

Q. You knew what an Alden dryer was at that time?

A. Yes sir.

Q. With the endless chains running outside, and inside of the stack?

A. I remembered all about it.

Q. You knew there was a patent on it?

A. I knew there had been.

Q. You knew you had a right to build it, if you wanted to?

A. Everyone had a right to when we built ours.

Q. Why did you not build the Alden dryer with endless chains?

A. Because we did not know the manner of how it was put together, as well as we did the one that was sitting right by the side of us.

Q. You never saw an Alden dryer in operation?

A. Yes sir, I have.

Q. Have you seen any dryer like the one that you did build, in operation, before you did build it?

A. I think I stated 2 or 3 times, only the one my father had.

Q. You have just stated that that was a different kind of a dryer; that that had a chain in it?

A. The one my father has, is the one improvement on the Alden; what he calls the Hunt Improved Alden, and the old Alden is the one he originally used.

Q. What satisfaction did the Alden give?

A. Good satisfaction, with the exception, as I say, there were too many trays, one above the other, and it was a little difficult to get a draught of hot air through the fruit.

100 Q. You also saw a Button dryer before you built yours?

A. I don't remember that I examined it before I built ours. I don't think I did. I knew of them.

Q. They gave good satisfaction?

A. So far as I know.

Q. Why did you not build a Button dryer?

A. Because I did not know anything about it. I took the one we knew something about and that we were copying the building of, and that was the one my father had. I did not go over the country looking at different dryers. I thought that was good enough.

Q. How far was there a Button drier from you?

A. When?

Q. At any time before you built yours?

A. When I lived on the ranch with my father, there was one within two miles of us.

Q. Did you see it?

A. Yes sir.

Q. Then you understood the Button drier?

A. I never examined it. I saw them drying fruit.

Q. You have been in there?

A. Yes sir.

Q. You said there were more Button driers in Sonoma County than all the rest put together?

A. I said I presume so.

Q. Do you still stick to that statement?

A. Yes sir.

Q. As an expert fruit drier, and having lived in Sonoma County as long as you have, do you undertake to tell me you did not know what the construction of a Button fruit drier was?

A. I do.

Q. How long have you lived in Santa Rosa?

101 A. 20 years or more.

Q. Are you willing to tell this Jury that you lived there for 20 years.

A. I have lived in and about Santa Rosa.

Q. That you are an expert fruit man, that there are more Button driers in that County, than all the rest put together, and that when you went to build your drier, you did not know enough about a Button drier, to build one like it? Is that what you want to tell the Jury?

A. I lived around Santa Rosa and Sebastapol for 20 years, been in the fruit business for 16 years, and I presume there are as many Button driers as all the others put together in Santa Rosa, so far as my knowledge goes. I never counted them and I mean to say, I never examined a Button drier, or the machinery in one, before we built ours.

Q. You mean to say also, those Button driers gave satisfaction?

A. So far as I know. I never inquired into it.

Q. You knew the Button patent had expired?

A. I know now. I did not know anything about it, at that time. It had not expired at that time.

Q. Explain to the Jury why it is, when you went to build your drier, you did not build a Button drier?

A. Because I was raised up on my father's ranch. He had a drier which gave good satisfaction. It worked well enough so far as I knew, to be as good a drier as we wanted. We could take that drier down and pattern after it, and build one like it.

I took the drier down and patterned after it, and built identically the same thing in Santa Rosa.

Q. You built the identical drier that your father had?

102 A. Except I put the furnace 3 and a half feet longer, and put 6 stacks on, instead of 5, which he had.

Q. Did you have an endless chain on your drier?

A. No sir.



Q. Your father did have in his?

A. No sir.

Q. He did at first?

A. Yes sir.

Q. The second one he cut the chain in two and riveted the links together?

A. That is what I said.

Q. Did you cut the chain in two, rivet the links together, and put them in your drier?

A. I never had any.

Q. Then why did you say you made the same identical drier that your father had?

A. I told you that my father took those chains out.

Q. When you built your drier, you put in solid bars like his, shown in this model of yours here?

A. Yes sir, we did.

Q. That is not like your fathers?

A. That is like my father's exactly.

Q. I thought you told me your father took his, and riveted the links together?

A. He first took the chains, cut them apart, and then took them out. I explained to the Jury he took two bars of iron solid, from bottom to top, and those brackets were riveted between those two bars of iron.

Q. That is just like this (pointing)?

A. Yes sir.

Q. This is the kind of a drier that you have used?

A. Yes sir.

Q. Then your father made several changes in his drier?

103 A. He made the change mentioned. He took the link chain out, and put the solid piece up, with the brackets riveted between them. Instead of having every other bracket riveted over one piece of iron, with the next one riveted between two pieces in a link chain.

Q. Were any of your driers built before the incorporation was formed?

A. Yes sir.

Q. What business were you in prior to the formation of the corporation?

A. I was in the fruit business.

Q. In the same place where you are now?

A. Yes sir.

Q. At Santa Rosa?

A. Yes sir.

Q. You had the same establishment?

A. I did not have the same plant; I had a little drier across the creek.

Q. What was the name of the firm before the incorporation?

A. Hunt Brothers.

Q. You simply transformed your business into an incorporation?

A. That is all.

Q. No change in the business?

A. No sir.

Q. How many driers did you have when you formed the corporation?

A. One—six stacks.

Q. That was in one building by itself?

A. Yes sir.

Q. After the corporation was formed, you built the others in the other building?

A. Yes sir.

Q. You have been using all those driers since the corporation was formed?

A. Yes sir.

Q. How long have you known Mr. Cassidy?

A. I have known him for some time. I have not known him personally, only since May, 1890.

Q. How long have you known of him, as being in the fruit business?

104 A. I don't know that I can say just how long I have known of him as being in the fruit business. I have heard of Mr. Cassidy, but to know what he was doing, I have no knowledge of him. I did not know who he was when I saw him. I knew there was a Mr. Cassidy in Petaluma.

Q. How far does he live from you?

A. Sixteen miles.

Q. In what connection did you know about him?

A. I heard of his being around the county fairs and other things.

Q. What things?

A. I heard people speak of seeing him at the county fair. I think I heard Mr. Wightman tell about his having a model of a drier that he was exhibiting at Petaluma, that was an inringement on his, and heard him give a conversation about it.

Q. Mr. Cassidy is pretty well known in Sonoma County as being connected with fruit dryers?

A. I presume so. I don't know how widely known he is.

Q. You heard from time to time that he was connected with fruit dryers?

A. I knew he had a fruit drier.

Q. Where was the fruit drier that you knew he had?

A. I never saw it, I heard it was in Petaluma.

Q. How long did you know of it being in Petaluma?

A. I could not say. I just have a faint recollection of hearing the thing mentioned; that is all I know about it.

Q. Where did you see it?

A. I never saw it at all.

Q. You simply say you heard of it?

A. That is all.

105 Q. You knew that Mr. Cassidy was connected with fruit driers?

A. Yes, sir; I might say that I knew it. I don't know that I ever gave the matter any thought. If someone asked me I might say he had a fruit drier.

Q. You also heard that he claimed he had a patent on a fruit-drier?

A. I think I heard it. I don't remember whether I did or not, before this came up.

Q. You must have known it, judging from what you just said about that conversation, concerning the Button drier.?

A. I think I knew all about it 8 or ten years ago, but I don't remember what I knew about it. I have a faint recollection of his having something to do with a drier. I heard Mr. Wightman speak about it, but that is lately. It gave me no concern. It is since this law suit came up, that I have inquired more about it than I ever did.

Q. Your hind sight was better than your fore sight?

A. Yes, sir; a great deal.

*Re-Direct Examination.*

MR. WHEATON. Q. As a convenient method of operating the movements of the drier, how does the lever which is used by you compare with the crank mechanism which is shown in Mr. Cassidy's Model Exhibit No. 2.

A. The lever used by us is far better in all ways. In using the crank in the old Alden it was continually getting out of order. These cog wheels are liable to get a little misplaced or something. It might slip in that way. Is a great deal harder and takes a great deal more power and does not work as nice by any means, while the crank has simply a fulcrum and a lever. You take hold of it in this way and let it down and the whole operation is performed  
 106 without any strain or any chance of any thing getting out of order; very little machinery; very simple, the fact of its not being complicated is its main advantage.

Q. Can you tell how the defendant's lever movement would compare with the method described in the patent for the use of the roller "O" and the ropes running over other rollers and connected at the bottom with the vertical posts?

A. Not clearly, because we have no model of it with the roller. While the roller winds by ropes in some way over the ropes, and

forces the posts up, and then allows it to roll back by means of winding it on a crank, forcing the posts up and allowing it to come back, this one is simply lifted by means of the lever which I consider very much better and more simple. I cannot explain thoroughly in regard to that rolling business as it is a very complicated affair, and without I had the roller I could not explain it. I do not understand all the details to explain it thoroughly. I understand it I think, but I could not show it to you without a model.

Q. I want it understood distinctly about the changes that your father made in the first Alden drier?

A. The first Alden dryer he made operated with four endless chains. In building the new drier he used those same chains if I am not mistaken. It is a good many years ago. I was not much of a lad then, and I don't remember. I think he used those identical chains, as near as my recollection serves, and afterwards took them out, and put in the solid bars of iron from bottom to top. I know that he used the same brackets the same thing exactly in the shape of the brackets that stick out on the chains, and the way they fasten. That is the reason that I think he used the same identical chains.

Q. Do you know for a certainty that he did use chains of some kind that had joints in them?

A. Yes sir.

107 Q. When he built a new dryer?

A. Yes sir.

Q. He changed those chains afterwards for the solid straps of iron?

A. Yes sir.

Q. How much of a hole was cut through the bottom of the dryer to allow each one of the chains to pass through it in the original Alden?

A. Very small. There was a hole cut just large enough to allow this bracket in going through to press in there. We put a little door to fill that hole, so that it would spring open as the bracket went through and fly back and stop all the cold air from going through.

A JUROR. Q. Is that the size of the chain that you use?

A. I don't know exactly; I think it is identically the thing, these links are about the same length; they are supposed to be four and a quarter inches apart there and every other link is a double bar riveted over the single one.

This is the same thing that we have there excepting that they are made in a little different shape.

(United States Letters Patent No. 124,944, dated March 26th, 1872, for an improvement in dryers, issued to Elisha Foote and Marshall P. Smith, were here introduced in evidence by the defendant, and read to the Jury, and were marked Defendant's Exhibit 8,



# Improvement in Driers.

No. 124,944

Patented March 26, 1872

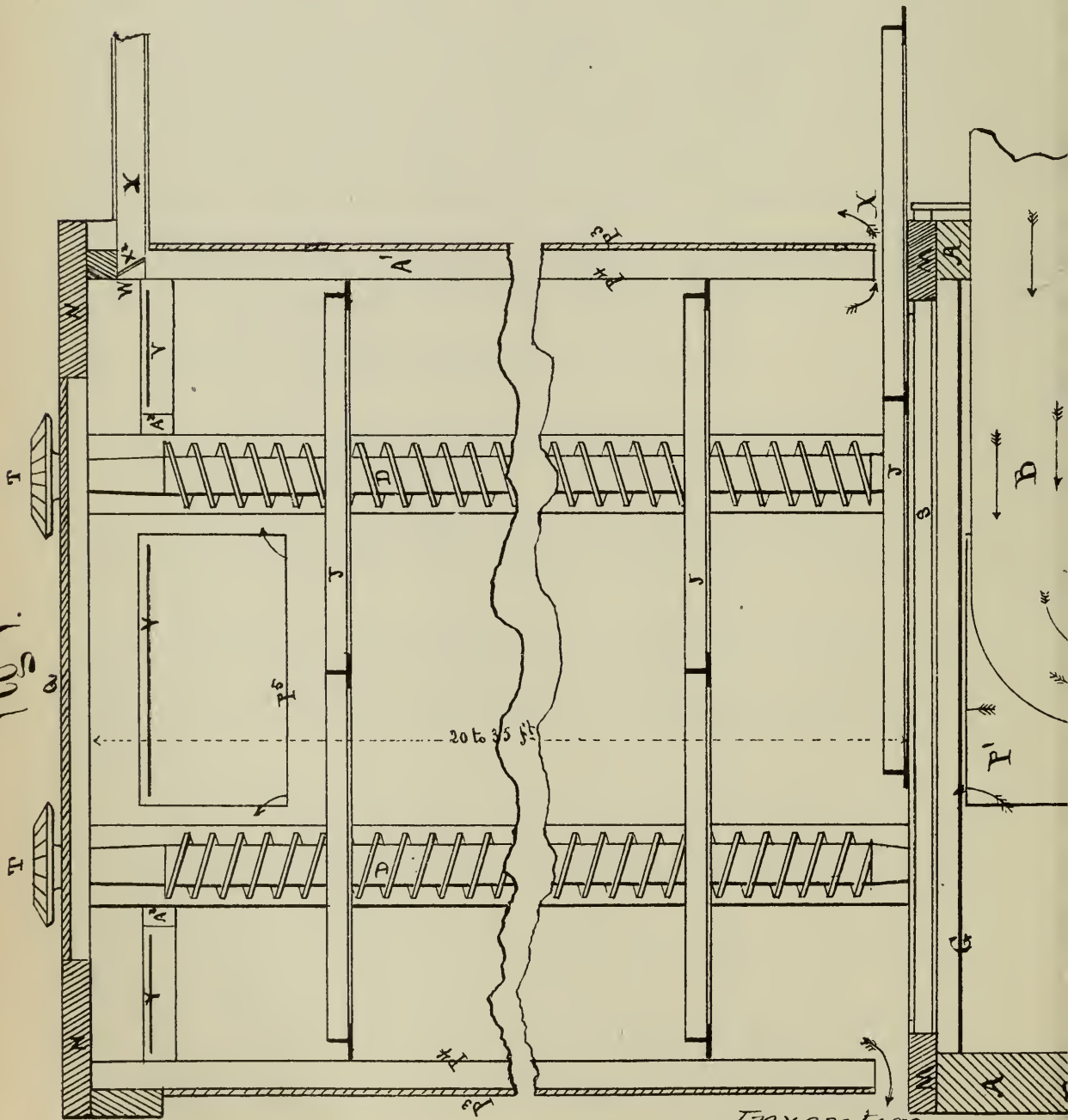
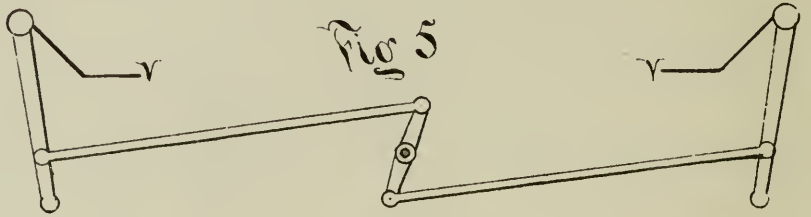

Fig. 1.

20 to 35 feet

Inventors.

Elisha Foote

Wm. P. Smith

Witnesses  
Jas. W. Kirkman  
J. H. ...



# Improvement in Driers.

124,944.

Patented March 26, 1872.

Fig 2.

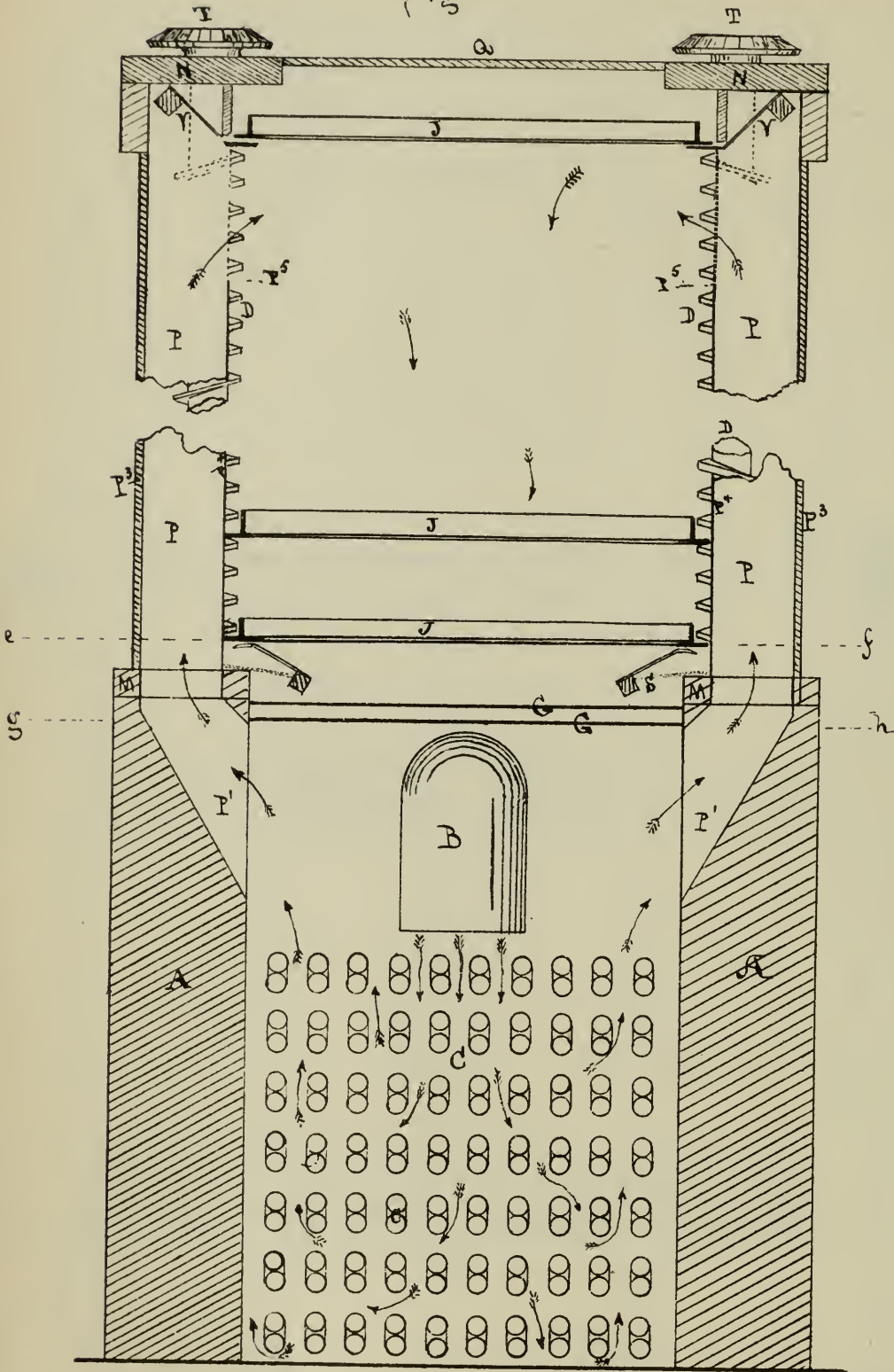

Witnesses.

H. Kirkman  
Woolfora

Inventors.

Elisha Foose  
Harshaw Pm





# Improvement in Driers.

No. 124,944.

Patented March 26, 1872

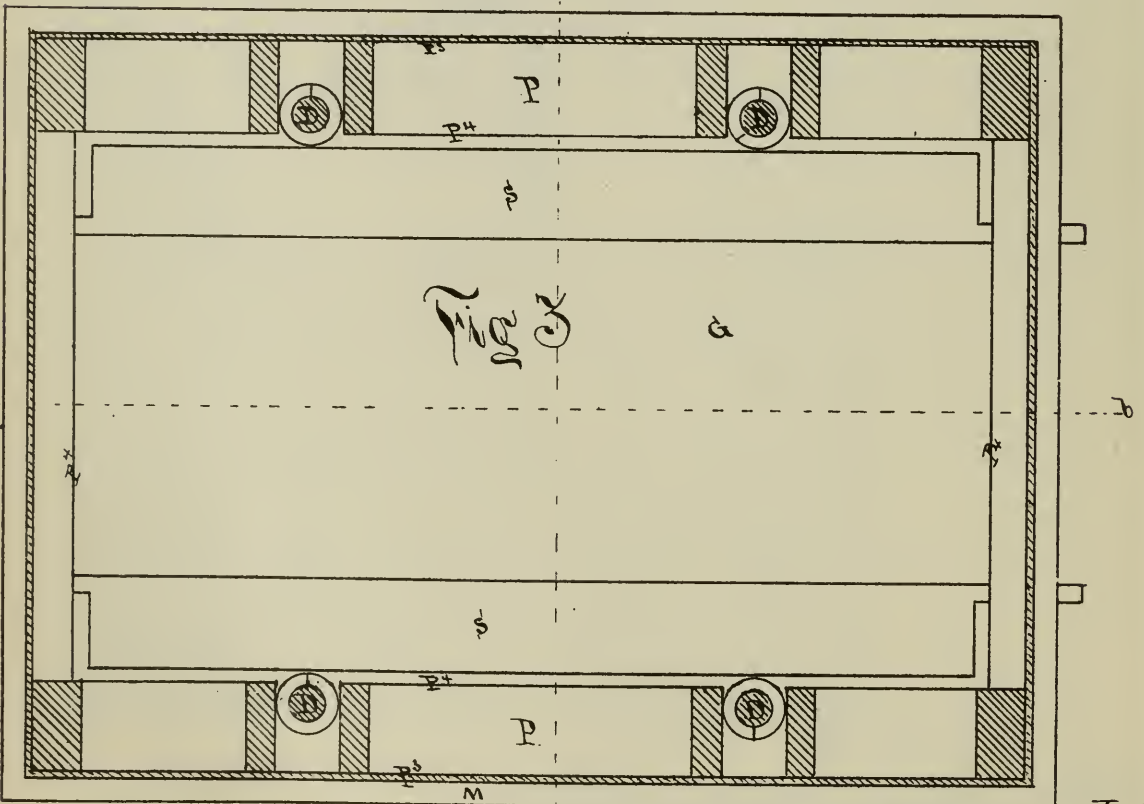
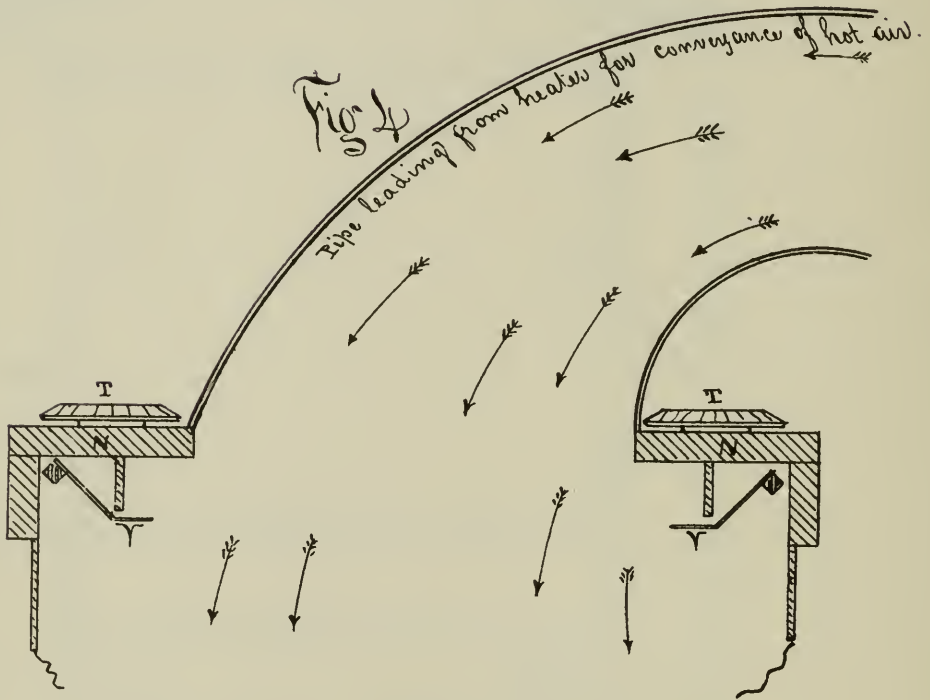

Wool for a  
W. Kirkman

Invest  
Elisha Soot  
Ph.

and are words and figures following, to-wit:

108

124,944.

UNITED STATES PATENT OFFICE.

Elisha Foote, of East Bloomfield, New York, and Marshall P. Smith, of Baltimore, Maryland.

*Improvement in Driers.*

Specification forming part of Letters Patent No. 124,944, Dated March 26, 1872.

We, Elisha Foote, of East Bloomfield, in the county of Ontario and State of New York, and Marshall P. Smith, of the city of Baltimore and State of Maryland, have invented certain Improvements in those Drying Machines in which the articles to be dried are subjected to a current of air artificially heated, of which the following is a specification:

This invention relates to a new mode of supplying the heated air; and consists of introducing a blast of hot air into the upper portion of the chamber, causing it to traverse the same and descend through or around the platforms containing the drying substances, and finally to escape at the lower portion of the chamber.

Although applicable to other descriptions of drying-machines, this improvement is especially useful in that class which consists of a series of platforms rising or falling in a vertical chamber. When such machines are constructed so that the air enters from below, and, rising, escapes from the top, if it be desired to cause the air to pass through the meshes or perforations of the platforms in succession, and thereby, in combination with a falling motion of the platforms, secure the advantages of an increasing heat and dryness, or, in combination with a rising motion of the platforms, effect a gradually decreasing heat, it will be necessary to make the platforms to fit the chamber closely; for if a space be left in the sides through which the air may pass, it will naturally seek the more unobstructed channel of escape, and all gradually increasing or decreasing heat processes be frustrated; and, further, if heated air be permitted to escape before it has absorbed a considerable quantity of moisture, (and this will be the result if the air is not retained a sufficient time in contact with the fruit,) a very great waste of heat and power will be sustained. When such close fitting platforms are employed, the fruit or vegetables must be so distributed as to allow spaces or interstices between the pieces to facilitate the upward passage of the air; or else a blast of sufficient power to force its way through the layers of fruit must be employed.

To correct these evils is the main object of this invention, and is accomplished, as before stated, by reversing the usual process, introducing the heated air at or near the top of the chamber, causing it to descend and traverse the same, and finally escape from the lower portion thereof. By this means the hot dry air collects around the upper platforms, distributes itself over the surfaces of

the fruit or vegetables, and descends only so fast as it is forced down by the volume of fresh air which is furnished by the blower or fan. It is therefore held for a longer time in contact with the drying-substance, and far more thoroughly saturated with moisture than is practicable by the usual methods; and, further, by this plan it is not necessary that the platforms should fit the chamber closely, for, as no means of escape from above are provided, the air will descend through the chamber in strata of uniform but gradually decreasing temperature, through which the rising or falling platforms will pass.

In the drawing hereunto annexed is shown the method of applying this invention to the vertical screw-drying tower of Marshall P. Smith, patented September 13, 1870.

Figure 1 is a vertical longitudinal section through line *a b*. Fig. 2 is a vertical cross-section through line *c d*, showing the flues P and P<sup>1</sup>. Fig. 3 is a horizontal transverse section through line *e f*. Fig. 4 shows the upper portion of the chamber and the mode of introducing hot air through pipes into the top. Fig. 5 shows the arrangement of coupling the flanges V V and S S.

A is a rectangular brick chamber, forming foundation for the framing and machinery of the drying chamber above, and containing the heating apparatus, which may be of any of the kinds in ordinary use; but the drawing shows an arrangement for heating the air, devised by Marshall P. Smith, and for which he has applied for letters patent. It will be found most convenient to locate this chamber in the cellar of the building, so that the manipulation of the fruit may be on the ground floor. The side walls of this chamber should be about twenty inches thick to allow space for the flues P<sup>1</sup> and afford a firm foundation for the screws. The end walls can be nine inches thick. This chamber is tightly covered with one or two sheets of boiler or cast iron, G, and from the upper part of the side walls proceed two flues, P<sup>1</sup>, which communicate with two vertical flues, P P, situated on the sides of the chamber between the screws. A<sup>2</sup> A<sup>2</sup> are 3x12 inch joists, forming part of the framing of the vertical tower. P<sup>3</sup> is the outside casing of the tower, and P<sup>4</sup> the zinc or iron lining of the interior. This mode of construction provides a smooth polished surface for the interior of the tower, makes a strong and substantial structure, and furnishes a space or flue, P, for the conveyance of heated air, at once simple, economical, and effectual. M is a plating of timber resting upon the brick foundation, upon which the sockets of the screws are bolted, and into which the upper framing is mortised. The zinc lining over this flue P is carried only to the point P<sup>5</sup>, leaving an opening through which the heated air enters the chamber. N is a heavy timber framing which supports the upper ends of the screws. T T are bevel-gears, which engage with other bevel-gears and which impart simultaneous motion to the screws D D. Q is the cover of the drying tower, which fits closely; and J J are platforms or trays,

resting in the threads of the vertical screws. W is the upper opening and X, the lower opening, through which the platforms are entered or discharged. Through the lower opening, or by others similarly situated, the saturated air escapes from the chamber. The upper opening W is provided with a close fitting door, X<sup>2</sup>, which drops down behind the trays as they are withdrawn, and the covered channel Y may be used to receive the tray until the door X<sup>2</sup> is closed, and prevent the escape of the heat.

To operate this machine on the principle of a gradually-increasing heat and dryness, the flanges S S are dropped until their outer edges rest upon the timber M. The platform is then entered, raised by the flanges S S, which press it against the lower end of the thread of the revolving screw, as shown in the drawing, until it is engaged. The flanges are then dropped ready to receive other trays, which follow each other at regular intervals. The trays are slowly raised by the screws, encountering the descending current of air as they progress, until they arrive at the upper end of the thread of the screw. They are then lifted by the flanges V V, as shown in the drawing, and removed from the chamber. These upper flanges V V, as well as the lower flanges S S, are moved by levers coupled together, as shown in Fig. 5. Should, for any purpose, it be desired to reverse this process and dry the fruit or vegetable by a gradually decreasing temperature, the trays will be entered at the top and withdrawn at the bottom.

The preceding specification describes the method of applying this improvement to the vertical-screw drier as generally constructed; but in some cases it may be desirable to dispense with the brick foundation chamber, and to place the heater on the top of the drying chamber. In this case the side flues P would not be used, and the base timber M would be made heavier, so as to support the superstructure, and a frame chamber should be placed on or near the top to contain the heater. This chamber should also be lined with sheet-zinc and cased outside to prevent loss by radiation. The cover Q should be removed, or an opening made there to allow the hot air to enter. There are difficulties of construction in this arrangement which counterbalance the advantages gained, and we prefer in such cases to heat the air in a separate adjoining chamber near the top, and convey it into the drying chamber by pipes, as shown in Fig. 4.

As before stated, it is not necessary that the platforms should fit the chamber closely, nor that they should be moved by screw mechanism; and we reserve to ourselves the right to apply the process of a descending column of heated air to all other descriptions of drying machines, whether for fruit, vegetables, grain, wool or any other purpose.

Having now described our invention, what we claim as new and desire to secure by Letters Patent, is—

1. The mode of supplying air to drying machines by introducing it at or near the top or upper portion of the drying chamber, causing it to descend through or around the platforms or trays containing the drying substances, and finally to escape from the lower portion of the chamber, in the manner and for the purpose substantially as described.

2. The process of drying animal and vegetable substances by placing the same on rising or falling platforms and exposing the same to a descending current of heated air, substantially as described.

3. The flues P P, and flanges S S and V V, when used in combination with a descending current in the drying chamber, substantially as described.

ELISHA FOOTE.

MARSHALL P. SMITH.

Witnesses :

W. W. WOOLFORD,

JAS. W. KIRKMAN.

109 (United States Letters Patent Number 134,528, dated January 7th, 1873, for an improvement in fruit driers issued to Alfred Edwards was here introduced in evidence by the defendant, were read to the Jury, and were marked Defendant's Exhibit 9, and are in words and figures following to wit :

UNITED STATES PATENT OFFICE.

Alfred Edwards, of New Haven, Connecticut, Assignor to Alfred R Edwards, of Chicago, Illinois.

*Improvement in Fruit Driers.*

Specifications Forming Part of Letters Patent No. 134,528, Dated January 7, 1873.

*To all Whom it May Concern:*

Be it known that I, Alfred Edwards, of New Haven, in the County of New Haven and State of Connecticut, have invented a new Improvement in Apparatus for Drying Fruit; and I do hereby declare the following, when taken in connection with the accompanying drawing and the letters of reference marked thereon, to be a full, clear and exact description of the same, and which said drawing constitutes part of this specification, and represents, in —

Figure 1, a front view; Fig. 2, a vertical central section on line *x x* of Fig. 3; and in Fig. 3, a vertical central section on line *y y* of Fig. 1.

This invention relates to the construction of an apparatus for the drying of fruits; the object being to facilitate the process so that the fruit is thoroughly dried for preservation in a few moments of time; and it consists in a drying-chamber provided with vertical endless bands, or their equivalents, carrying plates from the top



Fruit Driers.

No. 134,528.

Patented Jan. 7, 1873.

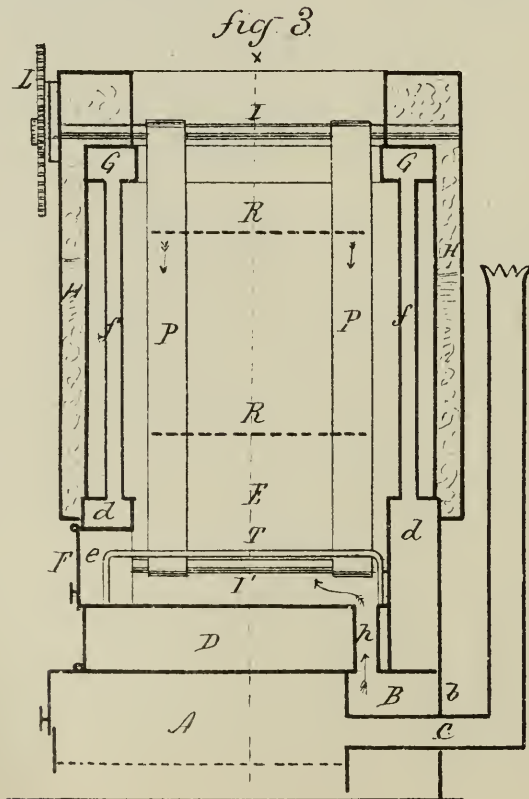
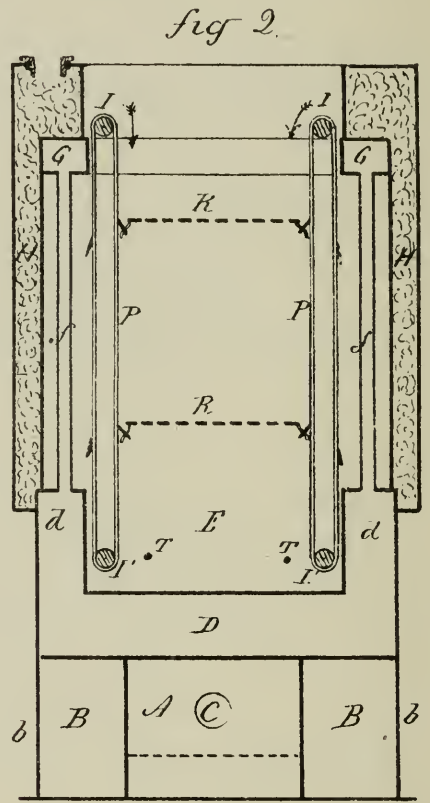
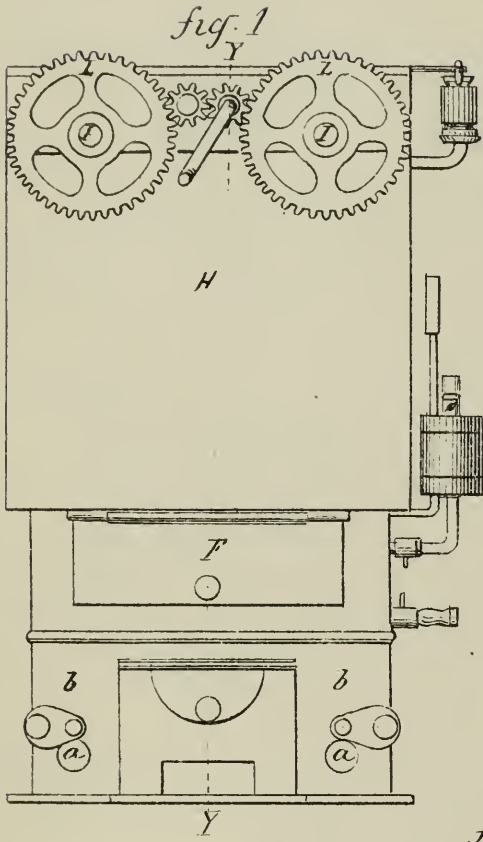

Alfred Edwards  
Inventor

Witnesses.

H. Sherman

By [Signature]



downward through the said chamber, upon which said plates, the fruit to be dried is placed, and in which chamber a constant circulation of hot air generated from a steam of hot-water heated surface is maintained, which dries the fruit while the said plates are passing from the top to the bottom; the construction of the said apparatus more fully appearing in the following description:

A is the fire-box, within which the fire or suitable heating apparatus is placed, upon either side of which is an air-chamber, B. The gas and smoke pass from the fire-chamber through the flue C or otherwise, the said air-passage extending to the rear and around the fire-box, as seen in Fig. 3. An outer case, *b*, incloses the fire-box and forms the said chambers.

Openings *a* are made for the admission of air into the said chambers. Above the fire-box, a boiler, D, is arranged to receive the water to be heated; the sides extending up, as at *d*, inclose the lower part of the chamber E, through one side of which an opening *e*, is formed, close by a door, F. Above the boiler and near the top of the chamber E the upper part or steam section of the boiler G is arranged, corresponding in form to the part *d*, and surrounding the chamber E in like manner, and this is connected to the boiler below by numerous tubes, *f*, which maintain a constant heat around the chamber E. The upper parts of the boiler and tubes are inclosed by a chamber, H, filled with a non-conducting material to prevent loss from the heat within. The chamber E, open at the top, is heated from the boiler, and a circulation maintained of heated air, the air passing through the chambers B heated by the fire-box, thence through an opening, *h*, into the chamber E. Upon opposite sides of the chamber E at the top a shaft, I, is arranged, to which a revolution is imparted by gears L attached upon the outside and made to revolve in opposite directions. A similar shaft, I', is placed at each side at the bottom and around these endless bands, chains, or equivalent devices, P, are arranged to traverse downward, as denoted by the arrows. On these bands arrangement is made for the attachment of open or perforated plates R, as seen in Fig. 3. These are placed in position upon the bands at the top, the fruit to be dried laid loosely thereon; then, the bands moving slowly, the plates thus introduced pass slowly down through the chamber E; the air circulating freely through the plates and fruit thereon, completely dries the fruit by the time it has reached the bottom. At the bottom opposite the opening *e*, bars T are arranged upon which the plates strike, the band passing on and leaving the plate on the said bars; then the door F is opened and the plate with the dried fruit removed; and so continuing, the plates being successively placed in at the top with the green fruit, passing down through the heated chamber, and removed when dried.

The heat being as great as the fruit will bear and not cook, and a constant circulation maintained, the passage down occupies but a

few minutes, and is sufficient to thoroughly dry the fruit.

The quantity of air admitted may be regulated at the openings.

The usual attachments for steam boilers should be applied for the inlet of water, escape of steam, safety, &c.

Instead of water in the boiler, live steam may be admitted from other sources, the fire serving to heat the air and superheat the steam. I, however, prefer water in the boiler, as described.

I claim as my invention—

The chamber E with a vertical steam or water heating apparatus, provided with the shafts I I' and endless bands P, or their equivalents, arranged to receive and carry the plates R, and constructed for the flow of heated air into and through the said chamber, in the manner and for the purpose described.

Witnesses:

ALFRED EDWARDS.

A. J. TIBBITS.

J. H. SHUMWAY.

110 (The defendant here rested.)

JOHN W. CASSIDY re-called in Rebuttal on behalf of the Plaintiff testified as follows:

MR. MILLER. Do you recognize the drawing I now show you?

A. I do. I dictated it to Mr. Wood, who made it for me in May, 1874.

MR. MILLER. I now offer it in evidence to show the date of the invention.

MR. WHEATON. We object to their coming in now to show the date of the invention. That was a part of their original case. They are bringing in matter that we are not allowed come in and contradict.

THE COURT. Your objection to it is in regard to it not being offered in the first place?

MR. WHEATON. Yes sir.

THE COURT. Then would it not be proper to show the date of the invention?

MR. WHEATON. It is a part of their main case.

THE COURT. I will allow the testimony.

*Exception No. 8.*

To which said ruling of the Court counsel for the defendant then and there duly excepted and hereby tenders this its bill of exceptions to the Court to sign and seal and the Court does hereby sign and seal the same.

(The drawing is marked Plaintiff's Exhibit A in Rebuttal) and the following is a blue print copy thereof.

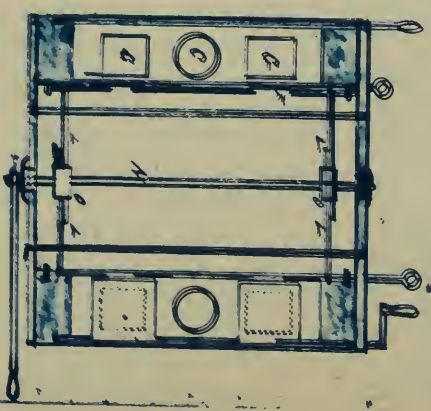
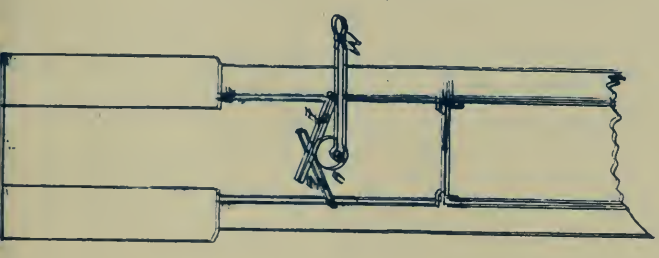
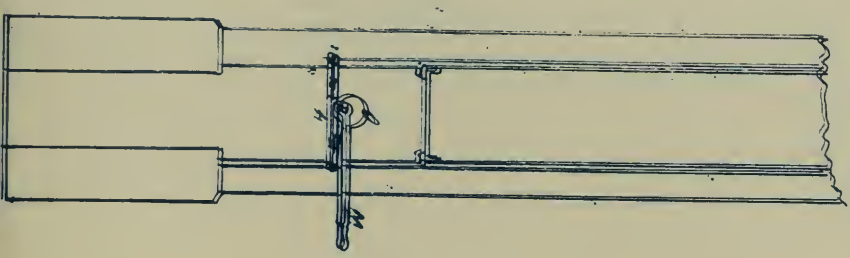
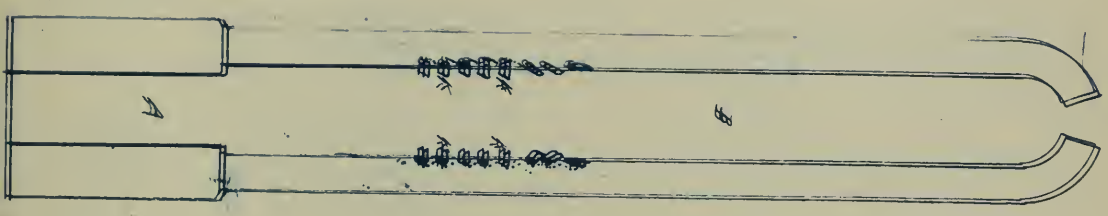
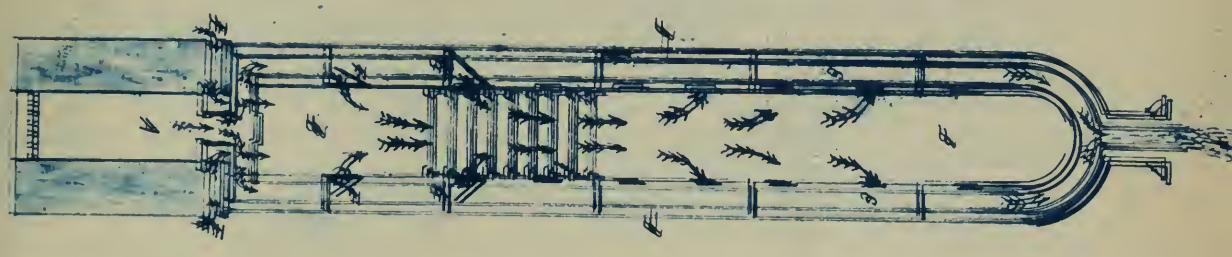
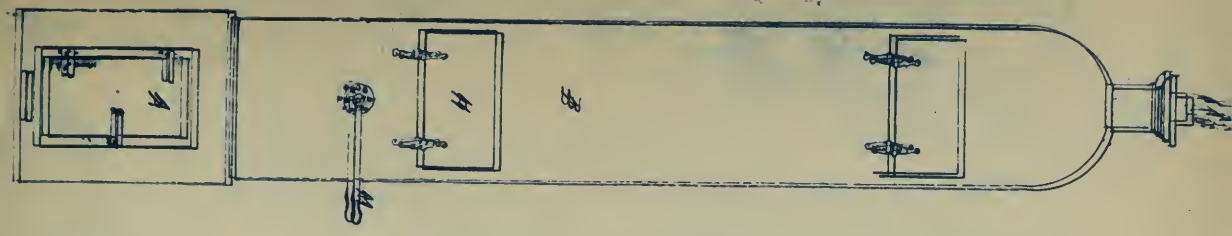

Design and drawings  
 made by 1874  
 W. W. Casady  
 H. F. Williams  
 London, England

At the  
of the  
the  
the  
the

112 MR. MILLER. Explain to the jury the mechanical device delineated in the drawing.

A. That represents a dry chamber showing it with trays with the chamber moving upwards. Here is the bottom and the furnace is underneath here. The trays are inserted in here just the same as in the model exhibited with the gravity catches. These drop out and run the trays up step by step, four, four and a half and five inches at a step. They are filled in until the chamber is full, and removed from the top. Here you will see a device of the catches. Some of the catches are standing horizontally, some are in and some are pressed back. This chamber has two posts on each corner, four stationary ones and four movable ones, the same as in that (pointing to Plaintiff's Exhibit 2). The movable posts were moved up by mechanism a step and then reversing it they were moved back the same distance in order to catch a new tray of fruit. When a new tray was inserted and the fruit was properly dried they had to have a certain amount of heat before they moved it again. The mechanism threw that up a step. Each tray from the bottom to the top moved all together, the same as is shown there (pointing to Plaintiff's Model Exhibit 2).

Q. Whose idea was embodied in that drawing?

A. Mine. I got up that idea about the latter part of March or first of April, 1874.

The first thing I did after conceiving it, I made a crude draft of it, and submitted it to an architect who drew this, and I instructed him—I stayed with him all the time he was drawing it and from this originated my patent. This was placed in the agency of the Patent Office, Mr. Dewey's, and from this device my patent  
113 was got out. The device shown in this drawing is the same thing as the device shown in my model Exhibit 3, so far as lifting the trays is concerned. My first idea was to use gravity catches. I built a dryer after conceiving this invention with gravity catches. That was the drier that was burned. When I built again I substituted a spring catch. The gravity catch gets gummed up with fruit, and a very little friction, the weight not being heavy enough, they will not come out in their proper place, the result would be that three or four of the catches would be on one side and it would throw your trays this way or that. To facilitate the work I added a spring catch which was not liable to get gummed up. In order to repair the gravity catches I had to let the heat go down, so as to get inside the chamber. With the catches I now use I need not let the fire go down. If a spring breaks I can pull them out with a pair of forceps and put in another in two or three minutes, and the trays are so adjusted I can remove them at any point to adjust that catch and work right along without any trouble. I have a drier on my place that I have used for ten consecutive years and I do not think that it averaged one

spring a year that broke.

Q. I find in your patent this statement. "Catches which would fall out by gravitation might be substituted for the springs in some cases." Why did you put that statement in your patent?

A. I had invented it and wanted to cover the ground. I thought that spring catches were better in operation than gravity. The first thing I did after getting this drawing made, I took it to Mr. Dewey, the patent agent, and had a caveat filed and in process of time, after I had found it a success, I applied for a patent.

114 Q. Are you familiar with what is known as the Button Dryer?

A. I built a couple of them, although I did not know there was a Button on the face of the globe.

Q. When did you know it?

A. In 1874.

Q. Where did you build it?

A. Petaluma.

Q. And it operated on the principle of this Button dryer?

A. Yes sir.

Q. Is your device an improvement over the Button device with regard to lifting the trays?

A. I think it is a material improvement, as I built two that represent my first one—Exhibit 3—I thought in order to avoid the catches not flying out, and the gum that gets in there we would simply use one spring in each corner, and insert a tray at the bottom and raise it one step, and it would rest upon four springs or catches. Then our trays were made with ears or lugs on the corners about four inches high, so the next tray that came in lifted up the tray already in and the last one we put in rests on those catches. The last tray rested on the catches and every tray on the top rested on the tray below until we got the chamber full. Nothing could be taken out except you took out the top. While in my dryer, Exhibit 2, this tray rests on the first here, and when that is moved up it rests there.

Any tray at any place could be taken out or inserted in any place in the whole dryer from top to bottom. There is a difference in fruit. Some kinds dry very rapidly. Some take twice as long. Fruit is apt to come mixed up. Very often the trays when half way or a quarter are sufficiently dry to take out. In order to save the fruit from being burned up it is necessary to remove it,

115 or you can take out part of it. I often take it out four springs high. In the Button dryer the different varieties of fruit have the same drying qualities as in that. You have fruit that will dry when you get half or quarter way up. To retain a sufficient amount of heat to dry that fruit, it would naturally spoil the fruit that was in here, and you could not remove it and it would have to go to the top. I found in running this I probably lost quite

a large percentage of the fruit that should all come out good. I found these defects in the dryer I made like the Button dryer. I abandoned that dryer, could not use it.

Q. Do you understand this model of the Smith dryer?

A. Yes. I have read the patent. I understand he puts in four vertical screws running from the bottom to the top of the chamber. These screws are all turned by mechanism on the top, so that they all work uniform. A third of a screw is on an incline, if it is not it could not be a screw. You take a screw with caliber strong enough to sustain the weight of a ten foot chamber, and it would naturally have to be two or two and a quarter inches in diameter. The thread would have to be square, and would have to be cut as deep as a quarter or three-eighths of an inch to make it safe to raise the trays. The screws are on an incline. Every one has the same pitched in the same way. In raising that it pitches the tray out. In putting a tray in here it is a hard matter in order to have those screws exactly alike to shut that tray in. Even if those trays all went up perfect, and they only have a quarter inch bearing on each side, the expansion and contraction of metal and wood would naturally throw them one in way of the other so that the trays could not be worked satisfactorily. If the contraction or expansion of the wood should throw it a quarter inch it would let all the trays  
116 down. If it contracted a quarter of an inch you could not get the trays in because they have to be made a close fit. You could not leave a half an inch the same as in those catches.

There is no bother with contraction or expansion on there. Again a screw ten feet long with a weight in there of eight hundred or twelve hundred pounds, bearing on this incline all the time with the heat softening the iron, it would expand. That would naturally bend and let them down. There is another serious objection. The cost of those screws would amount to about four dollars a foot for every foot you came up it would be four dollars a screw, saying nothing about the mechanism at the top.

L. W. SEELY, re-called on behalf of the Plaintiff, testified as follows:

MR. MILLER. Q. Have you examined the Button patent in evidence here?

A. I have. I think I understand it. I understand the model in evidence representing the Button device.

Q. Explain to the Jury the difference between the device shown in the Cassidy patent and that shown in the Button patent and model in regard to the device for elevating trays?

A. The Button Patent consists of a stack having beneath it a furnace for supplying hot air for the interior.

At the bottom of the stack is the table which is arranged to move vertically for a limited distance. In each corner at the lower end of the stack are four spring catches. The trays are put

in at the bottom and are elevated by the vertical movement of this table. As they rise each is caught by the spring catches of the bottom and supported by it. As other trays are put in the column of trays continues to rise until the drier is filled, when each one is removed successively from the top, and the whole column  
 117 being supported by the spring catches at the bottom. In the Cassidy the trays are supported independently upon catches arranged in a series upon vertical posts, and the trays are elevated by the movement of vertical movable posts also, provided with catches having space between them so that the trays in the Cassidy drier are supported independently on one another each upon the four catches at the corners of the driers. In the Button patent the trays rest upon one another and are all supported by the catches at the bottom. When the stack in the Button drier is filled with trays you could not remove a tray excepting the one at the top, because it is necessary to put an empty tray at the bottom and then operate the mechanism for elevating the trays before another one can be removed at the top. The trays in the Button patent rest one upon the other, and the entire column rests upon the four catches at each corner. I think there are four or five catches in the Cassidy device. In the Button drier there are four catches at the bottom arranged horizontally in the same plane. In the Cassidy patent, there is a continuous series of catches on the movable posts, and in stationary posts extending from the bottom to the top. In the Cassidy patent each tray loaded rests upon its own series of four catches. The entire load when the drier is full is distributed throughout the supporting posts. I do not find any such distribution of the load in the Button patent because all the trays arranged one on top of the other rest on these four catches at the bottom.

I have examined the Smith patent, consisting of four upright revolving screws amongst other things.

Q. Take that patent and the model before you and point out the difference between that and the Cassidy device?

118 A. In the Smith patent there are four screws, one at each corner of the drying chamber, and the trays which are elevated by the simultaneous movement of these screws rests in the threads of the screws, and are moved up by the operation of this gearing at the top. The difference between the Smith and the Cassidy device consists of course of the employment of stationary and movable posts or standards each provided with spring catches. I do not find any spring or other catches in the Smith device. The objection to this Smith device would be first, that the screws would take up too much room in the interior of the dryer. I don't know exactly what the proportions are but I understand the dryer to be about twelve or sixteen feet. If these proportions in the model are correct, that screw would be about three or four inches in diameter, consequently



it would take up a great deal of room in the interior of the stack.

Secondly, a screw like that fourteen feet high and three inches in diameter would be exceedingly expensive. Screw cutting is a very expensive process. There is another point a screw is a very excellent device for applying power slowly, but it generates an enormous amount of friction. These trays rest in the threads of these screws. I don't know whether it is in evidence that a dryer like this has ever been used. I have heard no testimony as to that, but I do not believe that it would be possible to elevate these trays by means of these screws without lubrication, and if that screw would be filled with oil, it strikes me that the mixture of oil and wet fruit would not be healthy for the users of it.

The combination of elements specified in the second claim of the Cassidy patent is not in the Smith device or the Smith patent. I do not find the combination in the Button patent. I have heard the testimony in regard to the dryer which has endless chains with lugs upon them such a dryer as that, according to the testimony that I have heard here, would not contain the combination of elements of Cassidy's second claim.

Q. I show you a model of the section of a chain marked Exhibit F, which is supposed to be a section of the Alden endless chain and ask you if you understand that device?

A. Yes.

Q. Would you call those lugs or projections catches?

A. No. I understand a catch to be a device which yields when another body passes over it, and then springs or falls back beneath it. These do not, because if these projections were riveted here solidly, so that they could not move this way and passed up the dryer, and turned around and passed back outside, and came around again inside, and always preserving the same relation to the chain, they will act precisely as they do now. So far as the drawing in that specification shows the device, there is no reason in the world why these catches should fall back, because when they do they are outside of the dryer, and not inside.

The testimony that I heard in regard to the Alden drier was that it was composed of a stack having endless chains which passed up through the drier out through a hole at the top, down on the outside, and in through a hole at the bottom, to the links of these chains were pivoted projections such as are shown here. The only time these projections fall by gravity is when they are outside of the stack. When they are inside of the stack they stand in this position (illustrating.) So far as the description goes there

120 is no reason why they should fall. They might just as well be riveted to this chain solidly, because they are only performing a function when they are inside of the stack. The fact that they fall down by gravity outside has nothing to do with the case, so far as I can see. So far as I can see the falling down of

those pivots on the outside of the doors in the endless chains accomplishes no function relative to the operation of the drier, unless they were in a confined space, and it would save a little room to have them fall down. While they are outside of the drier they are doing nothing of course. I know what the combination is contained in Cassidy's second claim. The elements are, a drier, stationary posts provided with catches, movable posts also provided with catches, and suitable mechanism for elevating the movable posts. I do not find that combination of elements in this Alden drier which has been testified to. I do not find in the Alden drier any movable posts, nor any stationary posts provided with catches nor any catches on any movable posts nor any mechanism for operating any movable posts.

*Cross-Examination.*

MR. WHEATON. Q. What do you find in the Button patent as a support on which the lower tray is placed which is put into the drier?

A. It rests [in a vertically moving table, or as he calls it a frame.

Q. In the Cassidy patent what supports do you find for the lower tray to be placed upon?

A. When the lower tray is put in it rests upon stationary projections.

Q. How do you know whether it rests upon the stationary projections or on the lower projections that are in the movable posts?

A. It might rest on either. The operator can regulate that.

Q. If the movable posts should happen to stand so that its lower catches were a trifle higher than the lower stationary catches then the lower tray of fruit would rest upon those lower movable catches, would they not?

A. Not necessarily, because the operator who is in charge of the machine would place those posts wherever he pleased.

Q. I am assuming that he has done so, and has placed those posts so that its lower catches are just a trifle higher than the stationary catches along side of them, and then put the tray in?

A. Then it would rest on the catches on the movable posts.

Q. In that case what would be the difference in the operation between those lower catches on the movable posts and the movable frame in the Button patent, so far as receiving that lower tray is concerned?

A. So far as one tray of fruit is concerned there would be no difference.

Q. Would that movable frame of the Button patent in that case perform exactly the same function that the lower movable catches would perform in the Cassidy patent?

A. Yes sir. My idea is this, that if the movable standards in the Cassidy patent had but one catch at the bottom it would be the equivalent of the Button patent, but it has a series of catches extending from the bottom to the top.

Q. Then if the lower movable frame in the Button patent is the same as the lower movable catches of the Cassidy patent, for the purpose of receiving the lower tray of fruit and lifting it up, 122 how would the stationary catches in the Button patent which would receive that lower tray of fruit when it was raised up one step compare with the stationary catches in the Cassidy patent which would receive the tray of fruit when raised up one step in his drier?

A. I cannot answer that question. I really do not understand it.

Q. What would be the difference between the stationary catches in the Button patent and the lower set of stationary catches in the Cassidy patent?

A. To what do you refer when you speak of the stationary catches in the Button patent?

Q. I mean the catches which receive and support the lower tray of fruit each time that tray is carried up, while the frame that you speak of is lower down, so that another tray of fruit may be shoved under the one that has just been raised?

A. Those are not stationary catches, they are spring catches.

Q. I simply mean catches that do not move up and down?

A. As I said before I think the four catches at the bottom of the Button patent are the equivalent of the four lower catches of the Cassidy patent, so far as raising the first tray is concerned, one step.

Q. How many catches do you find mentioned in claim two of the Cassidy patent?

A. The claim calls for "Stationary posts K provided with spring catches  $n n$  and the vertically moving posts L, provided with the spring catches  $n' n'$ ."

Q. Please count up those catches and see how many of them you make from the claim. What is it called the catches that are on the movable posts?

A.  $n' n'$ . It mentions two of them that is there are two 123 letters to designate them. The catches on the stationary posts are mentioned by a small  $n n$ . I find two letters for each in that claim.

Q. Can you give any reason why the combination of devices described in that claim is not filled when you have counted the lower sets of catches in the Cassidy patent, so far as those catches are concerned?

A. Certainly.

Q. Does that claim in terms call for any more catches than is

counted in the lower set, that is, four catches that are indicated by the letters  $n$  prime, and four catches that are indicated by the letters  $n$ ? Answer from the claim itself, and see if you can find any more spring catches mentioned in that claim than you find by counting the lower set of spring catches found in the Cassidy patent?

A. Yes, I find spring catches  $n$   $n$ .

Q. Do you not find spring catches  $n$   $n$  in a lower set?

A. You take them horizontally. I took them vertically as they are shown in the drawing.

Q. Does that claim call for them vertically?

A. No it does not, but the claim must be.

Q. Can you make any operative combination if you take that claim and count those four springs vertically, and leave off the spring catch on the other three corners?

A. Certainly not.

Q. What difference does it make, as to the operation of those upper sets of spring catches in the Cassidy machine whether the lower trays are lifted and held by spring catches or not, or whether they are lifted and held by something else?

A. You mean in regard to the upper. The idea in the 124 Cassidy patent is to keep the trays apart and allow the hot air to enter between them, and at the same time support each tray independently on its own series of catches.

Q. Suppose you support a tray independently, say on the third set of catches from the top, you also have a tray supported on the lower set of catches. What connection is there between that lower set of catches which supports the lower tray, and the third set of catches from the top which supports the upper tray?

A. There is no connection at all if you are only using two trays in the dryer.

Q. I am only using that for an illustration. Take the top set of catches in the Cassidy machine. What connection is there between the support afforded by that top set of catches and the support afforded by the lower set of catches in the same machine, when there is an upper tray in the dryer, and a lower tray in the dryer, and none between them?

A. They are both supported independently on their own catches.

Q. What joint action is there between the upper set of catches and the lower set of catches in the Cassidy machine, when there are two trays in the dryer one on the upper set of catches and one on the lower set of catches?

A. There is no joint action between them. The catches are independent.

Q. Now, you understand perfectly well, do you not, that in patent law, to be a patentable combination of devices, there has got to be a joint action between all the devices that comprise that com-

ination?

A. Yes sir, the devices comprised in the combination must co-act to produce a certain result.

125 Q. And if they do not co-act, although they are acting together, it is what is called in patent law an aggregation?

A. Yes sir.

Q. You also understand that an aggregation is not patentable?

A. No sir.

Q. How can you read into that claim this entire series of catches, without making that claim call for an aggregation of devices; instead of a combination of devices, all of which have a joint action with each other?

A. I think in all my experience I never saw a clearer example of a combination than is afforded by this claim.

Q. Just keep to the question.

THE COURT. I think you ought to allow the witness to answer.

A. I have got to take the elements of the claim.

MR. WHEATON. I want him to answer, and not avoid answering, by going off and stating something else.

Q. My question is, how can you read this entire series of spring catches, shown in this model of the Cassidy dryer, without reading into it an aggregation of devices instead of a combination, since you have shown by your testimony that those entire series do not co-act with each other?

A. I did not say the entire series did not co-act. The question you asked me was whether the top catches and the bottom catches co-acted. I said no, they acted independently.

You were supposing that there were only two trays in the stack.

126 Q. What joint action is there between the lower set of catches in the Cassidy machine, and the set of catches next above that lower set, which could not be found between the lower set of catches and the top set of catches?

A. Why if there were only two sets of catches, they would operate in the same way, in exactly the same way, within those limits. If the stack were sixty feet high, and there were only four sets of catches they would still continue to operate in the same way.

Q. In that operation they would operate independently of each other?

A. Now wait. Each one of the series of catches on the stationary posts, and each one of the series of catches on the vertically moving posts, acts independently of the other but the combination covered by the claim—

Q. You need not tell that.

MR. MILLER. I object to this. I demand that the witness be allowed to explain.

THE COURT. I think he should be allowed to explain.

MR. WHEATON. There is one rule of patent law,—

THE COURT. I understand what you are driving at. Some of the questions asked, the witness has stated are somewhat difficult for him to fully understand. He wants to explain what he means, in the answers which he gives to you. I think he ought to be allowed to do so.

MR. WHEATON. Your Honor does not see the force of my objection. I do not interrupt the witness while he is making an explanation of the device of machine. It is the hardest thing in the world to keep a professional expert—I mean no disrespect for the witness, because I think as much of him as any man living—from  
127 telling what the patent is for, and assuming in other words, the duties of the Court, and Jury. It is when he is telling what the patent is for, that I break in on him. So long as he confines himself to the description of the device contained in the claim, it is easy for him.

THE COURT. You ask the question in such a way that it seems impossible for him to answer intelligently without giving that explanation. If he can answer it yes or no, I shall instruct him to do so, but if he wishes to make an explanation, so as to give an intelligent answer, I think he should be allowed to make that explanation.

MR. WHEATON: I will state what I am driving at, and what I believe to be correct. I think that the claim of that patent is covered by the lower set of spring catches that is in the machine, that is, the lower set of spring catches in the movable posts in connection with the lower set of spring catches that are in the stationary posts, that is 8 catches altogether.

I think if the patent is valid, that any man would infringe it if he used just the 8 catches. That is all the claim calls for.

In order to show that the claims could not cover this entire set of catches above, I am proceeding to show that there is no joint action between them, and for that reason if that claim included the entire set of catches, from the top to the bottom, or even two sets of series, suppose there was only two sets of catches high, as there is no joint action between those two sets of catches, each act separately and independently of the other, that the claim of the patent in that case would cover an aggregation and therefore it would be void on its face. I am trying to demonstrate two things, first, that the claim does not call for more than those eight catches, and secondly, it can  
128 not be read to cover these entire sets without making the claim void.

THE COURT: Go on and ask your questions.

THE WITNESS: The difficulty you put me in is just this. You require me to say from the claim exactly what that covers, and you will not allow me to refer to the specifications or the drawing.

MR. WHEATON: Q. I do not ask you to tell what the claim covers; that is for the Court?

THE COURT: You claim it only covers a certain thing, and you will not allow him to say whether it does or not.

MR. WHEATON: Certainly.

THE COURT: You ought to be fair and allow him to tell what it does cover.

MR. WHEATON: It is for your Honor to tell what it covers.

THE COURT: I think that witness understands. You ask him if the claim covers this, and object to any explanation that he gives that it covers anything else. It seems to me that one would follow the other.

MR. WHEATON: I am very careful not to tell him what the claim does cover. At the close your Honor will instruct the jury what that claim covers. This evidence is for the purpose of instructing the Court, if it needs any instruction, I do not suppose it does, as to the action and operation of those devices.

Q. Please tell me how the two lower sets of catches, those that take the lower tray and those that take the first tray above it, could be joined in a combination with the other devices mentioned in the claim without making those sets of devices as so joined an aggregation instead of a combination?

A. You ask me how the lower series of catches on the 129 stationary posts and the lower series of catches on the movable posts, and the next two sets on the respective posts above them could be joined together without making an aggregation?

Q. That is the substance of it.

A. The ordinary definition of a combination is two mechanical devices which co-act together to produce some result.

In your question you assume a stationary post and a movable post and catches on each. Now if those two devices co-acting produce some result then they would produce a combination. That is just what they do. The movable post raises the tray until it slips over the catch of the stationary post. The movable post then falls back ready to put up another tray. I cannot conceive of a clearer example of a combination than is afforded by your illustration.

Q. You understand that a combination requires not only co-action but joint action?

A. Yes, sir.

Q. The action has got to be different in its nature from the different actions of the different devices added together?

A. Yes, but it has not necessarily to be at the same time.

Q. How is there any joint action between the lower set of catches, counting the eight catches as a set, and the next upper set of catches. What one act do they perform in which they both participate?

A. Now excuse me. You put me in a difficulty again. You include in your question both the movable posts and the stationary posts, making eight catches. You ask me what combina-

130 tion there is between the whole eight catches on both posts.

Q. What joint action?

A. What joint action there is between the whole eight bottom catches on both posts and the next eight catches including both posts.

Q. Yes, what one act takes place in which all these catches participate?

A. Why, they all participate each time a tray is raised.

Q. To what one act do they all participate?

A. Each time a tray is raised. I cannot answer it better than that.

Q. Don't you understand that there is no act performed there in which they all participate?

A. No, sir.

Q. I have a case here decided by the United States Supreme Court—

THE COURT: I don't think you had better discuss these questions as you go along. He says he does not understand you.

MR. WHEATON: I want to use this as an illustration.

THE COURT: You are objecting all the time to his giving a legal interpretation of anything. It seems to me it is a little out of place to read to him the legal view. If that is a matter for the Court it ought to be left to the Court. You understand that is the objection you are making, that you do not want him to legally construe things, yet you are proposing to read him a legal construction of the principles you are asking about.

MR. WHEATON: I am only getting at the facts of this case so as to ask him what joint action he could find there which  
131 could not be found in this set of facts. (Here Mr. Wheaton read to the witness the entire decision of the Supreme Court in the case of Adams vs. Bellaire Stamping Co. decided Nov. 16th, 1891. Reported in 12th. Supreme Court Reporter at page 66.) That was a combination of the hinge on the one side and a catch on the other to hold the two parts of a lantern together. You understand the construction of a lantern in that way?

A. I understand it is just like this, hinge here and catch here (illustrating with a watch).

Q. Can you describe any more of a joint action in the two lower sets of devices in this Cassidy machine, than would be found in the case of the hinge and the catch of the lantern for the purpose of holding those two parts together?

A. Yes sir.

Q. Please just do so.

A. There is a certain purpose to be accomplished by the device shown in that invention, and that is, to lift a fruit tray. To do that, the patentee provided four stationary posts, provided with spring catches and four movable posts, provided with spring



catches. The movable posts performed their part of the joint operation, by lifting the trays. They lifted them to a certain height at which time the catches on the stationary posts performed their function, and completed the operation, by springing out under the tray and then holding it. The two things operated together. It was a complete combination, both elements co-acting.

Q. You say that was a complete combination when the lower set of movable catches had received the tray and raised it up so that the first set of stationary catches received it?

132 A. Yes it was a complete combination at that place.

Q. If that combination was then complete at that point how can you bring into the same combination the other catches which were above and which were acting independently?

A. The combination was complete when there was two sets of catches, one above the other. That would make a fruit drier. That would afford room for two trays of fruit. If that combination is complete and operative, it does not make any difference how many trays you put above it. You simply increase the capacity of the machine or apparatus. If I am right when I say two sets of operatives would make a combination, then twenty sets of operatives would also make a combination.

Q. If that combination is complete there, adding another combination above at the same time, and another combination above that at the same time, would simply be adding combinations to each other?

A. Certainly.

Q. Would the second combination of those devices above the first one have any joint action with the lower combination?

A. You must tell me first what you mean by the second combination. I assume as the first combination the stationary post and a movable post each having two sets of catches. That is enough to operate two fruit driers. That would take two sets of catches on each post.

Q. In this machine there is shown two tiers of catches above that?

A. Two or three.

Q. And that would make another combination of the same kind?

A. Not an independent combination. It is all the same combination. You are simply increasing the capacity of the machine.

133 Q. How is there any joint action between this second combination of those elements assuming for a moment that you are right and the lower combination of those elements?

A. I can not distinguish between them. They all act together.

Q. Act together or act at the same time?

A. Act at the same time.

Q. What does this lower stationary set of catches in the Cassidy machine; what office do they perform?

A. They support the fruit tray. They have no other object so far as I know.

Q. While the fruit tray is resting on those four catches what other one of the devices is doing anything with that fruit tray?

A. None of them unless the machine is in operation. Then the other devices come into operation to lift the tray.

Q. When those other devices lift the tray do those lower stationary catches hold it any longer?

A. Of course not.

Q. Is not the work of those lower stationary catches entirely finished as quick as the other devices come into play and lift the tray off from them?

A. The lower stationary catches simply spring out again ready to receive another tray.

Q. What other device in that machine assists those lower stationary catches in holding or supporting that fruit tray?

A. No other device. The fruit tray is supported entirely at one time by those stationary catches.

Q. Does any other device in that machine assist those catches on the stationary posts in doing this work of receiving and sustaining the tray of fruit?

134 A. Yes, the catches on the movable post.

Q. How?

A. Simply because the catches on the stationary posts could not receive the fruit unless it was lifted up above its catches by the movable posts. It assists it to receive. It does not assist it in sustaining it.

Q. Do not the catches on the stationary posts receive that fruit just the same as if it were laid on here by hand?

A. It does at the bottom. In fact I suppose it is laid on by hand at the bottom.

Q. I am speaking about the bottom catches in the stationary posts. Now, if that bottom tray of fruit is put on those stationary catches by hand, and all those catches do is to receive and sustain that tray of fruit, please name another device in there, that assists in either receiving or sustaining that lower tray of fruit?

A. So far as sustaining that lower tray of fruit is concerned there is no other device. There is no other device there which assists the lower catches, they do all the work there. The tray is put in on the lower catches, and the lower catches receive it and hold it. Those lower catches act entirely independent of every other device in the machine at that point.

Q. There is no joint action between them and any other device in the machine is there?

A. No sir, not at that point, but there is just as soon as the operation of the machine commences. I do not understand you again. When the fruit tray is put in, the machine is standing still.

Q. Please explain all of the work that that lower set of 135 stationary catches performs independently of every other device in the machine?

A. The actual lower set of stationary catches perform no work at all except holding the tray.

There is no other device in the machine that assists that lower set of catches in holding the fruit. As far as that is concerned that set of catches might be a solid pin. It need not necessarily be a catch. For convenience it is made in that way.

Q. Then the action of that lower set of catches has nothing to do with any other device in that machine, that is, as a joint action?

A. I would hardly say that. The lower set of catches have a function to perform there. You have your lower set of catches and you put your tray in there in preparation to be raised. I would not like to say that those two devices do not co-act, the device for holding and the device for raising.

Q. In the case of the lantern, where the hinge was on one side, and the catch on the other for holding the lantern together, they co-act, that is, they both assist each other in holding the lantern together, or as you illustrated by a watch, there is a hinge on one side, and the catch on the other and they co-act.

A. I don't believe that is a good combination. It might be said that they co-acted to hold the lid of the watch in its place.

Q. You never have seen any of these dryers operate have you?

A. No sir. I know nothing from actual experience about how those screws in the Smith machine work. I don't know if the Smith machine has ever been in use or not.

Q. And if it was in the machine, you do not know any reason why the screw should not work?

136 A. I simply judge from my knowledge of screws in other machines. I have seen elevators raised in buildings by using a screw in each corner. They have worked very nicely; but they require a great deal of lubrication and generate a great deal of friction. Still they work as perfectly as any machine could work, but very slowly.

Q. Now suppose that the claim of the Cassidy patent should be held by the Court to apply only to the lower set of catches in the Cassidy patent, in that case, would you not find the same combination in that, as was in the Button patent?

A. I should think it was exactly the same thing.

JOHN W. CASSIDY, the plaintiff, re-called on his own behalf.

MR. MILLER. Q. Do you know Mr. Wightman?

A. I know him, not personally, I am not much acquainted with him.

Q. Did you ever have a conversation with him in regard to bringing suits for the infringement of your patent, if so, state what occurred between you?

A. I met him one time and I was anxious to bring suit, but I had not the money to do it, and I thought if I could get him to go in combination with me, I could prosecute the suit. I think that was the proposition I made to him.

Q. What steps have you taken, if any towards advertising your dryer in Sonoma County, so that the farmers of Sonoma County and the people engaged in fruit drying, as a business in Sonoma County, should become acquainted with your dryer?

A. For two or three years I had a full size drying machine  
137 at our Horticultural Fair, in Petaluma, running probably from 1882, up. The dryer was on public exhibition in the pavilion as you went in the building, on the right hand side of the main entrance, open to the inspection of any one who went to the fair. Circulars were nailed up at the side calling attention to it. Afterwards I exhibited it by models, at the same Fair.

Q. Was that before the Hunt Brothers built their dryer in 1890?

A. The first exhibit I think of a full size dryer was before they made it. I am not positive, but I think so. I think that was a way back somewheres about 1880. I furthermore advertised in the Petaluma "Argus", which has a large circulation, at different times, several different periods; sometimes a year at a time. Then I caused circulars to be distributed to different Post Offices where I could not find addresses, perhaps several hundred, or may be half, to be left around different points in Sonoma County.

Q. Is there any question but that the old gentleman Mr. Hunt, knew of the existence of your patent and dryer?

A. Not the least in the world. I told him about it. That was at that time—perhaps that was somewheres along about that time, I was at his house. He was excavating and he said he was going to build a dryer house, and he was speaking about the Alden machine. I asked him why he did not buy my patent, my machine. He said "No" he could build a better one. After that he built his machine.

Q. I believe you wanted to make some explanation in regard to the cost of those screws. You can do so if you desire, although I don't think it is very material.

A. I called the attention of the Jury to the fact that it cost \$4.00 a foot. Four screws would be 16 feet, which in a ten-foot dryer would be \$164.00.

138

*Cross Examination.*

MR. WHEATON. Q. Upon what do you base your calculation of the cost of those screws?

A. From the prices of competent machinists. I put them at the size of two and a quarter inch.

Q. Would not a screw  $2\frac{1}{4}$  inches through be capable of lifting 20 tons?

A. Most assuredly.

Q. A single screw?

A. I think it would, provided it stood perfectly vertical. My reason for putting in screws enough to lift 80 tons, is in order to get a thread deep enough to hold the edges of the trays. I figure on those screws being turned by threads cut in the lathe.

Q. Have you not seen cast screws?

A. Yes sir. That is the reason why I said you could not put in a cast screw there and have them work, because the friction would be too rough. The reason they would not work as well is that the friction would be too great. I have used a great many of them. I would get a boy with a lever and take cast iron nuts, and it would take me a day and a half to smooth them out. They are very much cheaper, the cast iron is cheaper than the wrought iron, I presume.

Q. You can buy these for four cents a pound?

A. You can not buy one with a square thread, not to be good for anything.

A. After doing all this advertising of your machine in Sonoma county, how many machines of yours did you sell in Sonoma county?

A. Three outside of my own, four. I will qualify that. The three in Sonoma I am part owner in. Half belongs to some partners, and half to me. One I sold to, I disremember who it was. I know they have got it on hand. It was a German. I could not pronounce his name. He lived at that time about a mile in the North West direction of Petaluma.

Q. At the time you were receiving royalties in the East, what were those royalties for?

A. Fruit trays.

Q. In the model that you have presented here, why have you substituted that crank and screw apparatus for the ropes and crank which is described in your patent?

MR. MILLER. I object to the question as irrelevant, immaterial, incompetent and not cross examination, and not properly in rebuttal. All I asked him about was the date of his invention, and these anticipating patents. That is a part of his main case.

THE COURT. Yes, I think so.

MR. WHEATON. He is the plaintiff in the case, and I have a right to cross examine him as often as I please.

THE COURT. That is true but you have had your opportunity.

MR. WHEATON. I did not notice when examining him before he had not used what is described in his patent.

MR. MILLER. You ought to have noticed it, and I say it is not cross examination.

THE COURT. It is not cross-examination.

*Ninth Exception.*

To which said ruling of the Court, counsel for the defendant then and there duly excepted and hereby tenders this its bill of exceptions to the Court to sign and seal and the Court does hereby sign and seal the same.

MR. WHEATON. Q. If you claim yours is an improvement over Button's how do you account for the fact, in spite of all your advertising there are so many more of the Button machines sold in Sonoma County, than there are of yours?

A. I presume his must come cheaper.

140 Q. Do you know the price at which the Button machines were sold?

A. I do not.

Q. Then that presumption is more a conjecture on your part?

A. That is all.

Q. Those screw matters, that you spoke of the danger of shrinkage, so that the trays would drop out. What did you intend the Jury to understand would shrink?

A. All iron and all wood has an expansion and a contraction. If the boxes of those journals were set in wood the boxes have a tendency to get loose. That would be one tendency to throw them out of gear. Again, if the boxes were perfectly sound in there there is a contraction on the wood. Take this bar here. Wet it, and it will be very much wider. That would throw the boxes further apart. When it shrinks again it would bring them together. As the wood contracts it brings them together, and as it expands, it would throw them further apart. These side pieces are made of wood. The head piece of the concern would shrink and have an expansion, and the tray would suffer in the same way. Pine will shrink endways as well as redwood. It is not a common thing for ordinary hard wood such as ash, or hickory or maple to shrink endways very much.

Q. If the timber that was on the edge of the tray would shrink edgeways, the timber that would form the machine would be apt to shrink edgeways?

A. Yes sir.

Q. That would keep the relative distances between these two posts the same?

A. You cannot put four screws in there. There are some endways and some sideways, while the endways may remain the same. You see there is a contraction here running with the grain of the wood, and when you take the crossways of the wood, it  
141 would be quite a difference. I will say still further, put a

metal plate on top of that, a three and a half foot metal plate, the heat expands metal very much, and cold contracts it. The same thing with the metal. It would probably have the same tendency to throw them out of gear.

Q. Take melted cast iron and pour it into a mold. Is not the amount that it will shrink between being just as hot as it can be in a solid form, and being cold, just an eighth of an inch in 16 inches?

A. I am not acquainted with the foundry business, and for that reason, I can not answer that question.

This closed the testimony in the case, and the foregoing constitutes all the testimony introduced material to the exceptions.

After argument by the respective counsel the Court proceeded to charge the Jury.

*Exception No. 10.*

Prior to said charge and to the argument of counsel the counsel for defendant submitted to the Court and requested the Court to give to the Jury the following instruction:—

“Any thing that is described in the specifications of the patent and not included in its claims is conclusively presumed not to be any part of the patentee's invention, and is not, covered by his patent.”

Which said instruction the Court then and there refused to give as requested.

To which said refusal of the Court counsel for the defendant then and there duly excepted and hereby tenders this its bill of exceptions to the Court to sign and seal and the Court does hereby sign and seal the same.

112

*Exception No. 11.*

Prior to said charge and to the argument of counsel the counsel for the defendant submitted to the Court and requested the Court to give to the Jury the following instruction:

“The records of the patent office which show the proceedings there had in determining what the patentee might claim as his invention, and ascertaining from them what the patent office consented to allow, and what the patentee consented to accept as the invention to which he was entitled are admitted in evidence.”

Which said instruction the Court then and there refused to give as requested.

To which said refusal of the Court, counsel for the defendant then and there duly excepted and hereby tenders this its bill of exceptions to the Court to sign and seal and the Court does hereby sign and seal the same.

*Exception No. 12.*

Prior to said charge and to the argument of counsel the counsel for the defendant submitted to the Court and requested the Court to give to the Jury the following instruction:

“ In such cases whenever it appears from those records that the officers of the patent office refused to allow a claim as it was originally drawn by the patentee, and that upon such refusal the patentee changed the language of the claim so as to leave out some part of what the claim included as it was first drawn, and that the patent office allowed and the patentee accepted the patent with that part left out of the claim which the patentee had first asked for in the claim as originally drawn, then the patentee is  
 143 “ not afterwards permitted to have the matter so left out from the original claim, covered by his patent either upon the ground that it is a mechanical equivalent of what is granted in the patent as issued, or upon any other ground.”

Which said instruction the Court then and there refused to give as requested.

To which said refusal of the Court, counsel for the defendant then and there duly excepted and hereby tenders this its bill of exceptions to the Court to sign and seal and the Court does hereby sign and seal the same.

*Exception No. 13.*

Prior to said charge and to the argument of counsel the counsel for the defendant submitted to the Court and requested the Court to give to the Jury the following instruction :

“ If the Jury believe from the evidence that in the original second claim which the plaintiff filed in the patent office he asked to have allowed as elements of the combination of the claim ‘ the vertically moving gosts L, provided with the springs *or other catches n* ’ and also believe that the officers of the patent office refused to grant the patent with the words ‘ or other catches ’ in the claim, and that thereupon the patentee or his attorney changed the language of the claim so as to leave out the words ‘ or other catches ’ and accepted the patent with these words left out of the claim, then the Jury must not consider that the combination of the second claim covers any combination of devices unless that combination of devices includes *spring catches* among  
 “ its elements.”

144 Which said instruction the Court then and there refused to give as requested.

To which said refusal of the Court counsel for the defendant then and there duly excepted and hereby tenders this its bill of exceptions to the Court to sign and seal and the Court does hereby sign and seal the same.

*Exception No. 13 1-2.*

Prior to said charge and to the argument of the counsel the counsel for the defendant submitted to the Court and requested the Court to give to the Jury the following instruction :

“ The specifications of the patent when they were first filed in



“ the patent office includes the following language, viz: ‘ Catches  
 “ ‘ which would fall out by gravitation might be substituted for the  
 “ ‘ springs in some cases.’ The Jury have the right to infer that  
 “ the ‘ other catches ’ mentioned in the claim as originally applied  
 “ for, and which were stricken out of the claim afterwards, were the  
 “ catches which might fall out by gravitation, mentioned in the  
 “ specifications, and that those were the very catches that the patent  
 “ office refused to permit the patent to cover as a part of the com-  
 “ bination of the claim.”

Which said instruction the Court then and there refused to give as requested.

To which said refusal of the Court counsel for the defendant then and there duly excepted and hereby tenders this its bill of exceptions to the Court to sign and seal and the Court does hereby  
 145 sign and seal the same.

*Exception No. 14.*

Prior to said charge and to the argument of counsel the counsel for the defendant submitted to the Court and requested the Court to give to the Jury the following instruction :

“ A patentee is bound by the claims of his patent and cannot  
 “ cover with his patent anything that is not distinctly claimed in  
 “ the patent as his invention.”

Which said instruction the Court then and there refused to give as requested.

To which said refusal of the Court counsel for the defendant then and there duly excepted and hereby tenders this its bill of exceptions to the Court to sign and seal and the Court does hereby sign and seal the same.

*Exception No. 15.*

Prior to said charge and to the argument of counsel, the counsel for the defendant submitted to the Court and requested the Court to give to the Jury the following instruction :

“ If the Jury believe that a skilled mechanic who was acquainted  
 “ with the construction and operations of the Alden drier would  
 “ know from his knowledge as a mechanic, that he could substitute  
 “ for the lifting apparatus of the Alden drier the lifting mechanism  
 “ of the plaintiff’s patent without any invention, and that such  
 “ mechanic would also know from his knowledge as a mechanic  
 “ that when the lifting mechanism of the patent was so substituted  
 “ for the lifting mechanism of the Alden drier that it would operate  
 “ to do the lifting as it does do it then the Jury must believe that  
 “ such substitution did not amount to any invention and should  
 “ find a verdict for the defendant.”

146 Which said instruction the Court then and there refused to give as requested.

To which said refusal of the Court counsel for the defendant then

and there duly excepted and hereby tenders this its bill of exceptions to the Court to sign and seal and the Court does hereby sign and seal the same.

*Exception No. 16.*

Prior to said charge and to the argument of counsel, the counsel for the defendant submitted to the Court and requested the Court to give to the Jury the following instruction :

“ If the Jury believe from the evidence that the so-called Alden drier was a drier which was constructed upon the same general plan as the drier that is shown in the plaintiff’s patent and that it received fruit trays at the bottom, one at a time and carried them up to the top where they were taken from the drier one at a time, and that it was operated by the use of endless chains with mechanism for driving them in the manner described by the plaintiff while he was a witness upon the stand and if the Jury also believe from the evidence that the only substantial difference between the said Alden drier and the drier described in the plaintiff’s patent consisted in the substitution of the spring catches in the stationary posts and the vertically moving posts with the spring catches in them, for the movable chains and lugs with the mechanism which operated them in the Alden drier, then the Jury should conclude that the difference between the two driers consists in the substitution for the chains and lugs of the Alden drier the spring catches and posts shown in the plaintiff’s patent and should also conclude that such change amounted only to the  
 147 “ substitution of one set of mechanical devices for the devices  
 “ used in the Alden drier, and that such substitution did not  
 “ constitute a patentable invention and that for this reason  
 “ the second claim of the plaintiff’s patent is void for the reason  
 “ that it does not constitute any patentable invention.”

Which said instruction the Court then and there refused to give as requested.

To which said refusal of the Court counsel for the defendant then and there duly excepted and hereby tenders this its bill of exceptions to the Court to sign and seal and the Court does hereby sign and seal the same.

*Exception No. 17.*

Prior to said charge and to the argument of counsel the counsel for the defendant submitted to the Court and requested the Court to give to the jury the following instructions :

“ There has also been introduced in evidence a patent on fruit dryers that was granted to Joel O. Button on the 22nd day of September, 1874. It was applied for on the 20th day of July, 1874.”

Which said instruction the Court then and there refused to give as requested.

To which said refusal of the Court counsel for the defendant then and there duly excepted and hereby tenders this its bill of exceptions to the Court to sign and seal and the Court does hereby sign and seal the same.

*Exception No. 18.*

Prior to said charge and to the argument of counsel the counsel for the defendant submitted to the Court and requested the Court to give to the jury the following instruction :

148 “ If the jury believe from the evidence that catches with-  
 “ out springs were described in the so-called Button patent,  
 “ which was issued prior to the time that the plaintiff ap-  
 “ plied for his patent and that the catches without springs were  
 “ operated in the machines made under the Button patent in the  
 “ same way, as were the spring catches used in the patent sued on,  
 “ and that such catches in the Button patent when so operated pro-  
 “ duced the same kind of results as were afterwards produced by the  
 “ spring catches in the patent sued on, then the jury should find that  
 “ it was no infringement of the plaintiff's patent to use the catches  
 “ without springs in the same kind of a combination as they were  
 “ placed in when they were used in the machines made under the  
 “ Button patent.”

Which said instruction the Court then and there refused to give as requested.

To which said refusal of the Court counsel for the defendant then and there duly excepted and hereby tenders this its bill of exceptions to the Court to sign and seal and the Court does hereby sign and seal the same.

*Exception No. 19.*

Prior to said charge and to the argument of counsel, the counsel for the defendant submitted to the Court and requested the Court to give to the jury the following instruction :

149 “ The jury are instructed that if the catches without springs were  
 “ used in the so-called Button patent prior to the time that the plain-  
 “ tiff applied for his patent and were so used in the Button patent  
 “ for the same purpose and in the same way that the plaintiff used  
 “ them in his invention, the fact that in the Button patent only one  
 “ set of the catches were used while in the dryer described in the  
 “ plaintiff's patent several sets of the catches are used, would  
 “ not amount to invention withing the meaning of the  
 “ law.”

Which said instruction the Court then and there refused to give as requested.

To which said refusal of the Court counsel for the defendant then and there duly excepted and hereby tenders this its bill of exceptions to the Court to sign and seal, and the Court does hereby sign and seal the same.

*Exception No. 20.*

Prior to said charge and to the argument of counsel, the counsel for the defendant submitted to the Court and requested the Court to give to the Jury the following instruction :

“ The Jury are instructed that the mere multiplication of parts or combinations for the purpose of repeating the same operations that, a single one of the parts or combinations produces does not constitute any patentable invention.”

Which said instruction the Court then and there refused to give as requested.

To which said refusal of the Court, counsel for the defendant then and there duly excepted and hereby tenders this its bill of exceptions to the Court to sign and seal and the Court does hereby sign and seal the same.

*Exception No. 21.*

Prior to said charge and to the argument of counsel, the counsel for the defendant submitted to the Court and requested the Court to give to the Jury the following instruction :

150 “ If the Jury believe from the evidence that there was described in the Button patent a table or frame on which the lower tray was placed and that that table or frame was moved up and down by proper mechanical devices and that when it was so moved upwards it carried the tray with it, and that there were catches which receded to allow the tray to pass upwards and which as soon as the tray passed then fell back under the edges of the tray in the same manner as the catches of the plaintiff’s patent are forced back by the springs under the edges of the tray that pass them in going upwards, and also believe that the table of the Button patent returned to its downwards position to receive another tray as soon as it had delivered the first one to the stationary catches, and if the Jury also believe that this operation of the Button patent could be constantly repeated until the stacks of trays filled the dryer, and that the upper tray could then be removed from the drier through an upper door or slide and another tray placed in the bottom as often as the upper tray was so removed, then the Jury should conclude that the Button patent is a full anticipation of the second claim of the plaintiff’s patent, unless the Jury believe that the spring catches are substantially different from the catches that were in the Button patent.”

Which said instruction the Court then and there refused to give as requested.

To which said refusal of the Court, counsel for the defendant then and there duly excepted and hereby tenders this its bill of exceptions to the Court to sign and seal and the Court does hereby sign and seal the same.

*Exception No. 22.*

151 Prior to said charge and to the argument of counsel, the counsel for the defendant submitted to the Court and requested the Court to give to the Jury the following instruction :

“ If the Jury believe from the evidence that the several sets of spring catches described in the plaintiff's patent were each operated independently of the action of each of the other sets of spring catches, and that there was no joint action between the lower set of spring catches and the other set of spring catches that were above them, then the Jury must conclude that there was no patentable combination between the lower set of spring catches shown in the plaintiff's patent and the sets of spring catches above them.”

Which said instruction the Court then and there refused to give as requested.

To which said refusal of the Court counsel for the defendant then and there duly excepted and hereby tenders this its bill of exceptions to the Court to sign and seal and the Court does hereby sign and seal the same.

*Exception No. 23.*

Prior to said charge and to the argument of counsel, the counsel for the defendant submitted to the Court and requested the Court to give to the Jury the following instruction :

“ If there is no joint action between the lower set of spring catches shown in the plaintiff's patent and the other sets of spring catches above them then the second claim of the patent is invalid if it includes in its combination any of said spring catches that are above the said lower set.”

Which said instruction the Court then and there refused to give as requested.

152 To which said refusal of the Court counsel for the defendant then and there duly excepted and hereby tenders this its bill of exceptions to the Court to sign and seal and the Court hereby sign and seal the same.

*Exception No. 24.*

Prior to said charge and to the argument of counsel, the counsel for the defendant submitted to the Court and requested the Court to give to the Jury the following instruction:

“ If therefore what the plaintiff had made prior to the application for the Button patent did not include spring catches then it did not include the combination of the second claim.”

Which said instruction the Court then and there refused to give as requested.

To which said refusal of the Court counsel for the defendant then and there excepted and hereby tenders this its bill of exceptions to

the Court to sign and seal and the Court does hereby sign and seal the same.

*Exception No. 25.*

Prior to said charge and to the argument of counsel, the counsel for the defendant submitted to the Court and requested the Court to give to the Jury the following instruction :

“ In this case the plaintiff’s patent does not cover the whole machine. He therefore can not recover as damages the profits that he made by making and selling the driers as an entire machine.”

Which said instruction the Court then and there refused to give as requested.

To which said refusal of the Court counsel for the defendant then and there duly excepted and hereby tenders this its bill of exceptions to the Court to sign and seal and the Court does hereby sign and seal the same.

*Exception. No 26.*

Prior to said charge and to the argument of counsel, the counsel for the defendant submitted to the Court and requested the Court to give to the Jury the following instruction :

“ The plaintiff has not proved that there was any established license fee existing between him and the people of California during the time in which the defendant was either making or using its fruit driers. He is therefore not entitled to recover any license fee as damages.”

Which said instruction the Court then and there refused to give as requested.

To which said refusal of the Court counsel for the defendant then and there duly excepted and hereby tenders this its bill of exception to the Court to sign and seal and the Court does hereby sign and seal the same.

*Exception No. 27.*

Prior to said charge and to the argument of counsel, the counsel for the defendant submitted to the Court and requested the Court to give to the Jury the following instruction :

“ Where the license fee or royalty is fixed by the patentee for a right to use all the inventions that are covered by all of the claims of his patent in cases where the patent has more than one claim, and it is shown that the defendant has infringed only a

“ part of the claims of the patent, in such cases the plaintiff

“ cannot recover as damages for the infringement of one claim the royalty or license fee which he has fixed as the price of the invention covered by all of the claims of the patent.”

Which said instruction the Court then and there refused to give as requested.

To which said refusal of the Court counsel for the defendant then and there duly excepted and hereby tenders this its bill of exceptions to the Court to sign and seal and the Court does hereby sign and seal the same.

*Exception No. 28.*

Prior to said charge and to the argument of counsel, the counsel for the defendant submitted to the Court and requested the Court to give to the Jury the following instruction :

“ If the plaintiff sold the right to use the patented inventions while the patent had eight or more years yet to run at a given price, that fact does not of itself prove that he could sell the patented rights for the same amount in later years when the patent had less than one-half as many years to run.”

Which said instruction the Court then and there refused to give as requested.

To which said refusal of the Court counsel for the defendant then and there duly excepted and hereby tenders this its bill of exceptions to the Court to sign and seal and the Court does hereby sign and seal the same.

*Exception No. 29.*

Prior to said charge and to the argument of counsel, the counsel for the defendant submitted to the Court and requested the Court to give to the Jury the following instruction :

155 “ Where a part of the patented inventions only are used by an infringer the plaintiff is bound to prove the damages occasioned to him by the infringement, and if he fails to prove the amount of such damages by reliable testimony he can recover only nominal damages.”

Which said instruction the Court then and there refused to give as requested.

To which said refusal of the Court counsel for the defendant then and there duly excepted and hereby tenders this its bill of exceptions to the Court to sign and seal and the Court does hereby sign and seal the same.

*Exception No. 30.*

Prior to said charge and to the argument of counsel, the counsel for the defendant submitted to the Court and requested the Court to give to the Jury the following instruction :

“ Where the patent is for an improvement, and not for an entirely new machine or contrivance, the patentee must show in what particulars his improvement has added to the usefulness of the machine or contrivance. He must separate his results distinctly from those of the other parts, so that the benefits derived from it may be distinctly seen and appreciated.”

Which said instruction the Court then and there refused to give as requested.

To which said refusal of the Court counsel for the defendant then and there duly excepted and hereby tenders this its bill of exceptions to the Court to sign and seal and the Court does hereby sign and seal the same.

156

*Exception No. 31.*

Prior to said charge and to the argument of counsel the counsel for the defendant submitted to the Court and requested the Court to give to the Jury the following instruction :

“ The patentee must, in every case give evidence tending to separate or apportion the defendant’s profits and the patentee’s damages between the patented features and the unpatented features, and such evidence must be reliable and tangible, and not conjectural or speculative ; or he must show, by equally reliable and satisfactory evidence, that the profits and damages are to be calculated on the whole machine, for the reason that the entire value of the whole machine, as a marketable article, is properly and legally attributable to the patentable feature.”

Which said instruction the Court then and there refused to give as requested.

To which said refusal of the Court counsel for the defendant then and there duly excepted and hereby tenders this its bill of exceptions to the Court to sign and seal and the Court does hereby sign and seal the same.

*Exception No 32.*

Prior to said charge and to the argument of counsel, the counsel for the defendant submitted to the Court and requested the Court to give to the Jury the following instruction :

“ In this case it is admitted that the first claim of the patent was not infringed, As the plaintiff has not introduced any testimony tending to show what the value of the combination covered by  
 157 “ the second claim was, nor any testimony tending to show  
 “ the amount of any damages suffered by him by the infringement of the second claim, nor any data by which  
 “ any such damages could be estimated, nor any established license fee or royalty for the use of the combination covered by the second claim, he can recover nominal damages only for the infringement of the second claim of the patent.”

When said instruction the Court then and there refused to give as requested.

To which said refusal of the Court counsel for the defendant then and there duly excepted and hereby tenders this its bill of exceptions to the Court to sign and seal and the Court does hereby sign and seal the same.



*Exception No. 33.*

Prior to said charge and to the argument of counsel, the counsel for the defendant submitted to the Court and requested the Court to give to the Jury the following instruction :

“ If the Jury find for the plaintiff on the other issues in the case they must find nominal damages only.”

Which said instruction the Court then and there refused to give as requested.

To which said refusal of the Court, counsel for the defendant then and there duly excepted and hereby tenders this its bill of exceptions to the Court to sign and seal and the Court does hereby sign and seal the same.

158 *The entire charge of the Court to the Jury was as follows :*

United States Circuit Court, Northern District of California.  
Tuesday, December 29, 1891.

THE COURT. “ *Gentlemen of the Jury* :—You have listened very patiently and attentively for several days to the testimony of witnesses in this case, and also to the argument of the counsel to-day.

You are the sole judges of the weight and credibility to be given to the witnesses who have testified on this trial. You are of course to take into consideration the interests, if any, which they may have, in determining the weight and credibility of the respective witnesses. You are the judges of the facts. The disputed questions of fact are to be determined by you under the law that may be given to you by the Court.

There are three questions involved in this case to which your attention has been called by Counsel ; first, as to whether or not the plaintiff's patent contains an invention ; second, whether there has been any invention ; and third, if there has, the amount of damages that are to be given.

Of course in the investigation of this case, if you should find there is no invention, that ends the matter, and there is nothing further for you to consider at all, except to find a verdict in favor of the defendant. If in the examination of the second question under instructions that may be given you, you should find there was an invention, you should then consider the question of infringement, and if there has been no infringement you should

159 stop there, all there would be for you to do would be to find a verdict in favor of the defendant. If on the other hand you should find there has been an invention and infringement, then it will become necessary for you to consider the third question, that of damages.

Several instructions have been prepared by counsel, some of which I will read as asked by them, and in course of giving you instructions on these several points not only confine myself to instructions asked by counsel, but some of my own.

On the part of defendant as asked by him I instruct you that before any inventor is entitled to receive a patent for his invention he must file in the Patent Office a written description of the same in such full, clear, concise and exact terms as to enable any person skilled in the art or science to which it appertains to make and use the same; and in the case of a machine, he must explain the principle thereof, and the best mode in which he has contemplated applying that principle, so as to distinguish it from other inventions; and he must particularly point out and distinctly claim the part, improvement or combination which he claims as his invention. This description and claim afterwards become the specifications which are a part of the patent.

No patentee can cover any invention by the claim of his patent which he has not described in the specifications which precede the claim. Any claim of a patent that covers any invention that is not described in the specifications is absolutely void.

A patent never covers any invention that is not included in its claims. The patent can cover nothing that its claims do not cover, no matter how much more may be described in its specifications.

160 The claims of a patent should never be construed to cover more than what the patentee invented. They should not be construed so as to give him any thing more than he invented, and they should not be construed so as to take from him any thing that he did invent, providing that is included within the terms of the claims.

The claim is the measure of the patentee's right to relief, and while the specifications may be referred to, to limit the claim, it can never be made available to expand it.

The defendant asserts in this case that the plaintiff's patent is void for the alleged reason that it does not cover any patentable invention. Defendant asserts that plaintiff did not invent the entire fruit dryer shown in the patent, but that there were earlier fruit driers of the same general kind, and which included the same general principles of operation and also included the same general kind of combinations as the combination included in the second claim of the plaintiff's patent. That all that the plaintiff did was to make such changes in the earlier fruit driers as any skilled mechanic acquainted with that class of ~~fruit~~ driers and their operations could make by virtue of his knowledge of his business as a mechanic, and without the exercise of any invention whatever.

The defendant in this connection has introduced in evidence several patents, which are earlier in date than the plaintiff's patent.

Testimony has also been introduced showing an older drier which is called the Alden drier.

The defendant asserts that some of the older driers described in the prior patents, and in the evidence, operated upon the

161 same principle as the drier which is described in the plaintiff's patent. It also claims that those older driers contained substantially the same combination of operative mechanical elements as is covered by the second claim of the plaintiff's patent.

Whether these things are so or not are questions of fact that the jury are to decide, under the instructions of the Court, as to the law bearing upon them.

Unless the plaintiff was the original and first inventor of the combination covered by the second claim of his patent the claim is invalid and the defendant will be entitled to a verdict.

If the plaintiff was the first and original inventor of that combination then the claim is valid, and if the defendant has infringed upon it the plaintiff will be entitled to a verdict.

The plaintiff has testified in substance that prior to his alleged invention he saw the so-called Alden drier; and that it operated in the drying of fruit in the same manner as the drier described in his patent operated, but that the mechanical construction of the parts that lifted the fruit trays was different and operated differently.

In the Alden patent it is asserted that there were four endless chains which were moved by mechanism in one direction only. That the chains had lugs attached to them which lugs received the trays of fruit one at a time at the lower part of the furnace and carried it upwards. That as fast as one tray had raised out of the way another tray was placed upon the next set of lugs that the chains carried, and this operation was repeated until the  
162 stack of the drier was full and the tray first put in had reached the top of the drier, at which place, when the fruit was sufficiently dry, the top tray would be removed through an upper door, and another tray of undried fruit would be again placed in the bottom, and in this manner the drier was kept full of trays of drying fruit.

The plaintiff has testified in substance that the trays of fruit were placed in the bottom of the drier described in his patent, one at a time; that it was carried up far enough to permit another to be inserted, and so on until the stack of the drier was full when the upper tray would be removed from the drier through a door at the top, and another tray of undried fruit would be placed in the bottom and in this way the drier described in the patent was kept full of trays of drying fruit.

The mechanism of both the driers has been described to you, and it is conceded that such mechanism is not the same in the two driers.

The defendant, however, contends that the operation of the two driers, as driers, are precisely alike, and that all the changes that the plaintiff made so far as the combination of the second claim is

concerned was to substitute equivalent mechanical devices in his drier for the chains and lugs that were used in the Alden drier. It is for you, gentlemen of the Jury, to determine as a question of fact whether this is true or not.

The Court instructs you that the making of a new form of combination which consists only in substituting known equivalents for the mechanism already used in a combination of the same character, and which is used for the same purpose, and which accomplishes the same result is only the exercise of mechanical skill, and does not constitute any patentable invention. This is true even though by the substitution of the mechanical equivalents better results are obtained.

163 The mere exercise of mechanical skill is not patentable.

Mechanical skill is one thing; invention is quite a different thing. Mere perfection of workmanship, however much it may increase the convenience, extend the use, or diminish expense, is not patentable.

If the Jury believe from the evidence that the only change made in fruit driers as far as the second claim of the patent goes was to substitute the posts and catches mentioned in said second claim with the proper mechanism for operating them for the chains and lugs used in the prior Alden drier, and if the Jury also believe that the posts and catches mentioned in said second claim were well known mechanical equivalents for the chains and lugs of the Alden drier at the time the plaintiff made his alleged invention, then the Jury should find that the second claim does not cover any patentable invention and should find for the defendant.

An improvement in a machine to be patentable must involve invention, and it is not invention to merely change an existing machine by substituting known mechanical equivalents for the devices used in a known combination.

Invention, in the sense of the patent law, is the finding out, contriving or creating something not existing and not known before, by the action of the intellect. It is the work of the head as distinguished from the work of the hand, and must result from the intuitive faculty of the mind put forth in search for new results or new methods. The true test whether a device is the result of invention

or mechanical skill, is whether an ordinary or a skilled  
164 mechanic would make it without other suggestion than his knowledge of the art.

As embodying these general ideas, I read from one of the authorities that was cited from the Supreme Court of the United States:—  
“A patentable invention is a mental result. It must be new and shown to be of practical utility. Everything within the domain of the conception belongs to him who conceived it. The machine, process, or product is but its material reflex and embodiment. A new idea may be engrafted upon an old invention be distinct from

the conception which preceded it and be an improvement. In such cases it is patentable. The prior patentee cannot use it without the consent of the improver, and the latter cannot use the original invention without the consent of the former. But a mere carrying forward, or new, or more extended application of the original thought, a change only in form, proportion or degree, the substitution of equivalents, doing substantially the same thing in the same way by substantially the same means, with better results, is not such invention as will sustain a patent.

These rules apply alike, whether what preceded was covered by a patent or rested only in public knowledge and use. In neither case can there be an invasion of such domain and an appropriation of anything found there. In one case everything belongs to the patentee; in the other to the public at large."

With reference to the question of anticipation which I omitted to speak of when I made the first general statement, several patents were introduced here of which this patent of the plaintiff is claimed to be anticipated.

165 Upon this point I instruct you as a matter of law, that by the term "anticipation" is meant substantial identity, that is to say, for a prior device to be an anticipation of a patented device, it must be substantially identical with the patented device. It is your duty as Jurors to determine the fact, from the evidence, whether any of the prior patented devices shown to have been in existence before the date of the plaintiff's patent were substantially identical with plaintiff's patented device. Unless you find such identity, the patent is not anticipated. In determining whether two devices are, or are not, substantially identical, you must determine whether or not they produce substantially the same results in substantially the same manner.

It is unnecessary to repeat in regard to each patent. These prior patents all come under the same general rule in what I have said in relation to the Alden patent, or any other prior patent. It must apply to all other prior patents. It is unnecessary to go through them as it has been done in some instructions asked.

If the Jury believe from the evidence that the combination of the second claim of the plaintiff's patent was anticipated by any of the prior patents either the so-called Alden machine, or by the Button patent they should find a verdict for the defendant upon that ground.

A combination of mechanical elements in order to be patentable must produce a different force, or effect, or result in combined forces or processes that are different from those given by their separate parts.

There has been some discussion here as to whether or not this was a patentable combination or an aggregation. No instructions have been asked by counsel on either side, and I suppose none are

requested upon that point. Unless counsel desire it, I shall  
 166 not submit that question to the Jury. If they do desire it I  
 shall give the Jury instructions as to the distinction between  
 a patentable combination and an aggregation.

MR. WHEATON. I did not have time. All I meant by that was  
 if these upper set of catches were to be read into the claim, that  
 that would be an aggregation, as the expert testified that they acted  
 independently of each other. As to the other part of it I do not  
 think it will apply.

THE COURT. I shall not give any instruction about that.

The plaintiff has introduced evidence by which he claims to  
 show that he made his invention before the Button patent was ap-  
 plied for. The party that undertakes to anticipate a patent by  
 proving that the patentee named in that patent was not the first  
 inventor of what the patent covers must prove an anticipation  
 thereof by proof clear, positive and unequivocal. If there is a  
 reasonable doubt as to the fact of the patent being anticipated the  
 doubt must be resolved in favor of the patent.

The second claim of the patent includes as a part of its elements,  
 spring catches. Until the plaintiff has made the combination with  
 spring catches he had not made the combination which is covered  
 by such second claim.

The second claim of plaintiff's patent is for a combination of the  
 following elements, viz;—a dryer, stationary posts provided with a  
 series of spring catches, a similar number of movable parts pro-  
 vided with a like series of catches and a suitable mechanism for  
 raising and depressing the movable posts.

If you find that the defendants have used all of those ele-  
 167 ments or their mechanical equivalents, combined together  
 and accomplishing substantially the same result in the same  
 way then they have infringed this claim, that is of course if you  
 find that there has been invention. If there has been no invention  
 you do not reach that question.

When, in mechanics, one device does a particular thing or ac-  
 complishes a particular result, every other device known or used in  
 mechanics which skillful and experienced workmen know will pro-  
 duce the same result, or do the same particular thing is a known  
 mechanical substitute for the first device. It is sufficient to consti-  
 tute known mechanical substitutes, that when a skillful mechanic  
 sees one device doing one particular thing, that he knows the other  
 devices with whose use he is acquainted, will do the same thing.

If you find that the gravity catches of the defendant do the same  
 thing in substantially the same way as the spring catches of  
 plaintiff, and that a skilled mechanic, upon seeing the spring  
 catches, work would know that gravity catches would do the same  
 thing in the same way, then the two are mechanical equivalents.

When a patent is not for a mere form, the patentee is not required

to claim his invention in all the forms in which it may be embodied. All that he is required to do is to describe and claim it in the best form he has contemplated using it, and having done that he will be protected in all forms by virtue of the doctrine of mechanical equivalents.

If the patent shows that the plaintiff contemplated using gravity catches as well as spring catches and the two are mechanical equivalents, then it was not necessary for him to claim both forms, but

when he claimed one form that included the other.

168 The fact that in his original application plaintiff claimed as an element of his second claim spring or other catches and that he afterwards struck out the words 'or other', leaving the element simply spring catches, does not limit his claim to spring catches nor deprive him of gravity catches if the latter are mechanical equivalents of spring catches.

If you find that the defendants have used all the specified elements of plaintiff's second claim, except that they have substituted gravity catches instead of spring catches, and you further find that gravity catches do the same thing in substantially the same way as the spring catches, then the defendants have infringed that claim.

There is an instruction asked by the plaintiff in regard to anticipation. I have already given one of my own. It is substantially the same, and I will give that.

The defendant has put in evidence several patents prior to that of plaintiff and claims that they anticipate the plaintiff's patent. Now by anticipation is meant substantial identity. Unless these prior patents show substantially the same thing as that covered by the plaintiff's second claim, they are not anticipations. This is a question of fact for you alone to determine. That is to say you must determine whether the Cassidy invention is substantially identical with any invention or device shown or described in these prior patents or any of them, and unless you find such identity, then the Cassidy invention is not anticipated.

Upon the question of damages I shall give you very few instructions. I shall instruct you that a license fee cannot be allowed as damages in a patent case unless it is proved that a license

169 fee was fixed by the plaintiff and that he was able to sell rights to others at that price in sufficient quantities to show that the public acquiesced in that price and voluntarily paid it for the right to use the invention.

There is no fixed royalty of license fee that can be applied as a rule of damages in this case unless the plaintiff has proven that he was able to sell rights to use the inventions at the price fixed by him. If he did not make sales in such numbers and at such uniform prices as to create an established license fee then he is not entitled to claim any such license fee as a rule of damages in this case.

If however you find from the evidence that plaintiff has established a fixed uniform royalty for the use of his invention by others, and has collected the same from other persons in several instances, then I instruct you that the said royalty is the proper measure of damages.

Now gentlemen those are all the instructions I propose to give to you in this case. It will be your duty when you go to your jury room to appoint some one of your number as foreman; to carefully consider the several points upon which you have been instructed, first as to whether this invention is one that was patentable under the instructions given by the Court, whether it was anticipated by the prior patents, whether it has been infringed, and if you find all those things in favor of the plaintiff you will determine the amount of damages if any to which the plaintiff is entitled.

It takes a unanimous number to agree on a verdict. When you agree on your verdict notify the officer in charge, and he will inform the Court and officers, if they are present. If they are not present he will so inform you, and you will be at liberty to find a verdict and seal it up, and deliver a sealed verdict to the  
170 officer. In the event that the Court should not be present when you arrive at a verdict, seal it up, and leave it with the officer and be present to-morrow morning at eleven o'clock.

Whenever you agree on a verdict, if you do, first inform the officer, and he will inform you if the Court is ready to take your verdict.

The Clerk has handed me two forms of verdict which you will take with you, as well as the patents in this case, if you desire them.

Of course if under the instructions you find for the defendant your verdict will be, "We the Jury find in favor of the defendant." If in favor of the plaintiff, it will be "we the Jury find in favor of the plaintiff," filling up the amount of damages.

*Exception Thirty-five.*

In the course of the charge to the Jury the Court gave the following instructions:

"If you find that the defendants have used all of these elements or their mechanical equivalents, combined together and accomplishing substantially the same result in the same way then they have infringed this claim, that is of course if you find that there has been an invention. If there has been no invention you do not reach that question.

When, in mechanics, one device does a particular thing or accomplishes a particular result, every other device known or used in mechanics which skillful and experienced workmen know will produce the same result, or do the same particular thing is a known



mechanical substitute for the first device. It is sufficient to constitute known mechanical substitutes, that when a skillful  
 171 mechanic sees one device doing one particular thing, that he knows the other devices with whose use he is acquainted, will do the same thing."

To which said portion of said charge counsel for the defendant then and there duly excepted and hereby tenders to the Court this its bill of exceptions to sign and seal, and the Court does hereby sign and seal the same.

*Exception No. 36.*

In a subsequent portion of the charge the Court instructed the Jury as follows:—

"If you find that the gravity catches of defendant do the same thing in substantially the same way as the spring catches of plaintiff, and that a skilled mechanic, upon seeing the spring catches work, would know that gravity catches would do the same thing in the same way, then the two are mechanical equivalents."

To which said portion of said charge counsel for the defendant then and there duly excepted and hereby tenders to the Court this its bill of exceptions to sign and seal, and the Court does hereby sign and seal the same.

*Exception No. 37.*

In a subsequent portion of the charge, the Court instructed the Jury as follows:—

"When a patent is not for a mere form, the patentee is not required to claim his invention in all the forms in which it may be embodied. All that he is required to do is to describe and claim it in the best form he has contemplated using it, and having done that he will be protected in all forms by virtue of the doctrine of mechanical equivalents."

To which said portion of said charge counsel for the  
 172 defendant then and there duly excepted and hereby tenders to the Court this its bill of exceptions to sign and seal, and the Court does hereby sign and seal the same.

*Exception No. 38.*

In a subsequent portion of the charge the Court instructed the Jury as follows:—

"If the patent shows that the plaintiff contemplated using gravity catches as well as spring catches and the two are mechanical equivalents, then it was not necessary for him to claim both forms, but when he claimed one form that included the other."

To which said portion of said charge counsel for the defendant then and there duly excepted and hereby tenders to the Court this its bill of exceptions to sign and seal and the Court does hereby sign and seal the same.

*Exception No. 39.*

In a subsequent portion of the charge the Court instructed the Jury as follows:—

“The fact that in his original application plaintiff claimed as an element of his second claim spring or other catches, and that he afterwards struck out the words ‘or other,’ leaving the element simply spring catches, does not limit his claim to spring catches nor deprive him of gravity catches if the latter are mechanical equivalents of spring catches.”

To which said portion of said charge, counsel for the defendant then and there duly excepted and hereby tenders this its bill of exceptions to the Court to sign and seal, and the Court does hereby sign and seal the same.

*Exception No. 40.*

In a subsequent portion of the charge the Court instructed the Jury as follows:—

173 “If you find that the defendants have used all the specified elements of plaintiff’s second claim, except that they have substituted gravity catches instead of spring catches, and you further find that gravity catches do the same thing in substantially the same way as the spring catches, then defendants have infringed that claim.”

To which said portion of said charge counsel for the defendant then and there duly excepted and hereby tenders to the Court this its bill of exceptions to sign and seal, and the Court does hereby sign and seal the same.

*Exception No. 41.*

In a subsequent portion of the charge the Court instructed the jury as follows:

“If however you find from the evidence that plaintiff has established a fixed uniform royalty for the use of his invention by others, and has collected the same from other persons in several instances, then I instruct you that the said royalty is the proper measure of damages.”

To which said portion of said charge counsel for the defendant then and there duly excepted and hereby tenders this its bill of exceptions to the Court to sign and seal, and the Court does hereby sign and seal the same.

At the close of the Judge’s charge the following occurred:

MR. WHEATON: We except to instruction that the gravity catches are the equivalent of the spring catches. That exception is based on the ground that all other kinds of catches were abandoned in the Patent Office.

MR. MILLER: There is no such instruction as I understand.

MR. WHEATON: Also to that part of the instruction which

174 tells the jury that all forms of equivalent devices would be the same thing as the spring catches. The best I can do is to give the substance. Your Honor will know what I mean. And that they may claim the gravity as the equivalent of the spring catches. I think it came in two forms. I do not contend that the gravity catch is not the equivalent of a spring catch. My contention is that under what occurred in the Patent Office they abandoned all equivalents and were estopped from claiming them.

Upon the rule of damages we except to the giving of any instruction that the plaintiff may under any circumstances in this case be allowed an established license fee, for the reason that there is no evidence to show that there was any established license fee for the one claim of the patent. There is not a particle of evidence on that ground, and that a license fee for a whole patent cannot be the rule of damages where only a part of the patent has been used.

MR. KIERCE: We except to your Honor's refusal to give the sixth instruction. We also except to your Honor's refusal to give the seventh. We also except to your Honor's refusal to give the eighth. We also except to your Honor's refusal to give the ninth. We also except to your Honor's refusal to give the 10th. We also except to your Honor's refusal to give the eleventh.

THE COURT: The substance of the eleventh is just the same as the one prior. It has already been given. That is the reason I did not give that. It is correct. I had already given it.

MR. KIERCE: We also except to the instruction given, No. 13. Some of the instruction was left out.

175 THE COURT: All that was left out of that were the words "all of."

MR. KIERCE: We except to the 14th as given, because some words were inserted. To the 23rd because it was not given. Also the 24th because it was not given. Also to the 27th. Also the 28th. Also the 29th. Also the 30th. Also the 31st. Also the 34th. Also the 35th. Also the 38th. Also the 39th. Also the 40th. Also the 42nd. Also the 43rd. Also the 45th. Also the 46th. Also the 47th.

THE COURT. The 46th. I will now give to the Jury. That is on the question of damages. I am glad you called my attention to it. "It is, in all cases the burden of proof is upon the plaintiff to show the amount of his damages. The damages must be proved by competent, reliable evidence. They must not be guessed at or conjectured." You can consider that as a part of the instructions on the question of damages.

MR. KIERCE. Also the 47th. Also the 48th. Also the 49th. Also the 50th, and also the 51st.

THE COURT. The 51st should be given. If they do not find any royalty the plaintiff would be entitled only to nominal damages. You can consider that as being given to the Jury.

A JUROR. Suppose that the Jury should consider these appliances were old in other machines, and never attached to a fruit drier before. Is it patentable as a fruit drier?

THE COURT. A party has a right to use old elements if they are put together in such a form as to produce new and useful results?

The foregoing proceedings occurring immediately after the charge of the Court to the Jury furnish the only foundation for the exceptions to the said charge hereinabove allowed in this bill of exceptions.

The Jury then retired and soon returned with a verdict in favor of the plaintiff for damages in the sum of one thousand three hundred and fifty dollars.

And now in furtherance of justice and that right may be done the defendant presents the foregoing as its bill of exceptions in this case and prays that the same may be settled and allowed, and signed and certified by the Judge as provided by law.

WHEATON, KALLOCH & KIERCE,

*Attorneys for Defendant.*

The foregoing bill of exceptions is correct and is hereby allowed and settled.

(Signed)

THOMAS P. HAWLEY,

*Acting Circuit Judge of the U. S. Circuit Court, Northern District of California.*

(Endorsed:) Filed February 20, 1892.

L. S. B. SAWYER,

*Clerk.*

*Assignment of Errors.*

177 In the United States Circuit Court of Appeals, for the Ninth Circuit.

HUNT BROTHERS FRUIT PACKING COMPANY,  
*Plaintiff in Error.*

vs.

JOHN W. CASSIDY,  
*Defendant in Error.*

*Assignment of Errors.*

Now comes the Hunt Brothers Fruit Packing Company, the Plaintiff in error, herein, by Wheaton, Kalloch & Kierce, its Attorneys and counsel and particularly specifies the following as the errors upon which it will rely, and which it will urge upon its writ of error in the above entitled cause.

1.

That the Court erred in overruling the objection of the counsel for the plaintiff in error to the following question, asked the plaintiff John W. Cassidy:

“ Q. With that as a basis I will repeat the question and ask you which in your judgment, would be the cheapest to construct yours or the Alden ?”, and in permitting the plaintiff to answer the same.

2.

That the Court erred in refusing to instruct the Jury at the close of the plaintiff's case to bring in a verdict in favor of the plaintiff in error.

3.

That the Court erred in sustaining the objection of the defendant in error, to the introduction in evidence of a copy of the specifications and drawings of United States Letters Patent No. 179,275, granted to Samuel W. Craven for an Improvement in Drying houses, dated June 27, 1876.

4.

178 That the Court erred in sustaining the objection of the defendant in error to the introduction in evidence of a copy of the specifications and drawings of Letters Patent of the United States No. 171,202, granted to L. & F. Whittlesey for an Improvement in Fruit Driers, bearing date December 14th, 1875, on the ground that it was not an anticipation of the patent of the defendant in error.

5.

That the Court erred in sustaining the objection of the defendant in error to the introduction in evidence of a copy of the specifications and drawings of Letters Patent of the United States No. 171,202, granted to L. & F. Whittlesey for an Improvement in fruit Driers, bearing date December 14th, 1875, on the ground that it could not be offered for the purpose of showing the state of the art at the time defendant in error received his patent.

6.

That the Court erred in sustaining the objection of the defendant in error to the following question asked the witness C. Wightman :

Q. “ What if anything, did Mr. Cassidy say to you about bringing suit ?

7.

That the Court erred in sustaining the objection of the defendant in error, to the offer of the Plaintiff in error to show by the patent office reports of the year 1870, the date and the claims of the patent granted to Charles Alden by the Government of the United States.

8.

179 That the Court erred in overruling the objection of the plaintiff in error to the offer of the defendant in error to introduce in rebuttal a drawing made by the defendant in error, for the purpose of showing the date of his invention, and allowing the same to be introduced in evidence in rebuttal.

## 9.

That the Court erred in sustaining the objection of the defendant in error, to the following question asked him on cross examination,  
 “Q. In the model that you have presented here, why have you substituted that crank and screw apparatus for the ropes and crank which is described in your patent?” and in refusing the answering of said question.

## 10.

That the Court erred in refusing to give the following instruction to the Jury as requested by the Plaintiff in error,  
 “Any thing that is described in the specifications of the patent and not included in its claims is conclusively presumed not to be any part of the patentee’s invention, and is not covered by his patent.”

## 11.

That the Court erred in refusing to give to the Jury the following instruction requested by the plaintiff in error,  
 “The records of the patent office which show the proceedings there had in determining what the patentee might claim as his invention, and ascertaining from them what the patent office consented to allow, and what the patentee consented to accept as the invention to which he was entitled, are admitted in evidence.”

## 12.

180 That the Court erred in refusing to give to the Jury the following instruction requested by the plaintiff in error:  
 “In such cases whenever it appears from those records that the officers of the patent office refused to allow a claim as it was originally drawn by the patentee, and that upon such refusal the patentee changed the language of the claim so as to leave out some part of what the claim included as it was at first drawn, and that the patent office allowed and the patentee accepted the patent with that part left out of the claim which the patentee had first asked for in the claim as originally drawn, then the patentee is not afterwards permitted to have the matter so left out from the original claim covered by his patent either upon the ground that it is a mechanical equivalent of what is granted in the patent as issued, or upon any other ground.”

## 13.

That the Court erred in refusing to give to the jury the following instruction requested by the plaintiff in error :

“ If the jury believe from the evidence that in the original second claim which the plaintiff filed in the Patent Office he asked to have allowed as elements of the combination of the claim ‘ the vertically moving posts, provided with the springs *or other catches n,*’ and also believe that the officers of the Patent Office refused to grant the patent with the words ‘ or other catches’ in the claim, and that thereupon the patentee or his attorney changed the language of the claim so as to leave out the words ‘ or other catches ” and accepted the patent with those words left out of the claim, then the jury must not consider that the combination of the second claim covers any combination of devices unless that combination of devices includes *spring catches* among its elements.”

## 14.

That the Court erred in refusing to give to the jury the following instruction requested by the plaintiff in error :

“ The specifications of the patent when they were first filed in the Patent Office includes the following language, viz :

‘ Catches which would fall out by gravitation might be substituted for the springs in some cases.’ The jury have the right to infer that the ‘ other catches ’ mentioned in the claim as originally applied for, and which were stricken out of the claim afterwards, were the catches which might fall out by gravitation, mentioned in the specifications and that those were the very catches that the Patent Office refused to permit the patent to cover as a part of the combination of the claim.”

## 15.

That the Court erred in refusing to give to the jury the following instruction requested by the plaintiff in error :

“ A patentee is bound by the claims of his patent and cannot cover with his patent anything that is not distinctly claimed in the patent as his invention.”

## 16.

That the Court erred in refusing to give to the jury the following instruction requested by the plaintiff in error :

“ If the jury believe that a skilled mechanic who was acquainted with the construction and operations of the Alden drier would know from his knowledge as a mechanic, that he could substitute for the lifting apparatus of the Alden drier the lifting mechanism of the plaintiff’s patent without any invention, and that such mechanic would also know from his knowledge as a mechanic that when

the lifting mechanism of the patent was so substituted for  
 182 the lifting mechanism of the Alden drier that it would operate to do the lifting as it does do it then the jury must believe that such substitution did not amount to any invention and should find a verdict for the defendant."

## 17.

That the Court erred in refusing to give to the Jury the following instruction requested by the plaintiff in error:—

"If the Jury believe from the evidence that the so-called Alden drier was a drier which was constructed upon the same general plan as the drier that is shown in the plaintiff's patent and that it received fruit trays at the bottom, one at a time and carried them up to the top where they were taken from the drier one at a time, and that it was operated by the use of endless chains with mechanism for driving them in the manner described by the plaintiff while he was a witness upon the stand and if the Jury also believe from the evidence that the only substantial difference between the said Alden drier and the drier described in the plaintiff's patent consisted in the substitution of the spring catches in the stationary posts and the vertically moving posts with the spring catches in them, for the movable chains and lugs with the mechanism which operated them in the Alden drier, then the Jury should conclude that the difference between the two driers consists in the substitution for the chains and lugs of the Alden drier the spring catches and posts shown in the plaintiff's patent, and should also conclude that such change amounted only to the substitution of one set of mechanical devices for the devices used in the Alden drier, and that such substitution did not constitute a patentable invention and that  
 183 for this reason the second claim of the plaintiff's patent is void for the reason that it does not constitute any patentable invention."

## 18.

That the Court erred in refusing to give to the Jury the following instruction requested by the plaintiff in error:—

"There has also been introduced in evidence a patent on fruit driers that was granted to Joel O. Button on the 22nd day of September, 1874. It was applied for on the 20th day of July, 1874."

## 19.

That the Court erred in refusing to give to the Jury the following instruction requested by the plaintiff in error:—

"If the Jury believe from the evidence that catches without springs were described in the so-called Button patent which was issued prior to the time that the plaintiff applied for his patent and that the catches without springs were operated in the machines



made under the Button patent in the same way, as were the spring catches used in the patent sued on, and that such catches in the Button patent when so operated produced the same kind of results as were afterwards produced by the spring catches in the patent sued on, then the Jury should find that it was no infringement of the plaintiff's catches to use the catches without springs in the same kind of a combination as they were placed in when they were used in the machines made under the Button patent."

## 20.

That the Court erred in refusing to give to the Jury the following instruction requested by the plaintiff in error:—

184 "The Jury are instructed that if the catches without springs were used in the so-called Button patent prior to the time that the plaintiff applied for his patent and were so used in the Button patent for the same purpose and in the same way that the plaintiff used them in his invention, the fact that in the Button patent only one set of the catches were used while in the drier described in the plaintiff's patent several sets of the catches are used would not amount to invention within the meaning of the law."

## 21.

That the Court erred in refusing to give to the Jury the following instructions requested by the plaintiff in error:—

"The Jury are instructed that the mere multiplication of parts or combinations for the purpose of repeating the same operations that a single one of the parts or combinations produces does not constitute any patentable invention."

## 22.

That the Court erred in refusing to give to the Jury the following instruction requested by the plaintiff in error:—

185 "If the Jury believe from the evidence that there was described in the Button patent a table or frame on which the lower tray was placed and that that table or frame was moved up and down by proper mechanical devices, and that when it was so moved upwards it carried the tray with it, and that there were catches which receded to allow the tray to pass upwards and which as soon as the tray passed then fell back under the edges of the tray in the same manner as the catches of the plaintiff's patent are forced back by the springs under the edges of the tray that pass them in going upwards, and also believe that the table of the Button patent returned to its downward position to receive another tray as soon as it had delivered the first one to the stationary catches, and if the Jury also believe that this operation of the Button patent could be constantly repeated until the stacks of trays filled

the drier and that the upper tray could then be removed from the drier through an upper door or slide and another tray placed in the bottom as often as the other tray was so removed, then the Jury should conclude that the Button patent is a full anticipation of the second claim of the plaintiff's patent, unless the Jury believe that the spring catches are substantially different from the catches that were in the Button patent."

## 23.

That the Court erred in refusing to give to the Jury the following instruction requested by the plaintiff in error:

"If the Jury believe from the evidence that the several sets of spring catches described in the plaintiff's patent were each operated independently of the action of each of the other sets of spring catches, and that there was no joint action between the lower set of spring catches and the other sets of spring catches that were above them, then the Jury must conclude that there was no patentable combination between the lower set of spring catches shown in the plaintiff's patent and the sets of spring catches above them."

## 24.

That the Court erred in refusing to give to the Jury the following instruction requested by the plaintiff in error:—

"If there is no joint action between the lower set of spring catches shown in the plaintiff's patent and the other sets of spring catches above them, then the second claim of the patent is invalid if it includes in its combination any of said spring catches that are above the said lower set."

## 25.

That the Court erred in refusing to give to the Jury the following instruction requested by the plaintiff in error:—

"If therefore what the plaintiff had made prior to the application for the Button patent did not include spring catches then it did not include the combination of the second claim."

## 26.

That the Court erred in refusing to give to the Jury the following instruction requested by the plaintiff in error:—

"In this case the plaintiff's patent does not cover the whole machine. He therefore cannot recover as damages the profits that he made by making and selling the driers as an entire machine."

## 27.

That the Court erred in refusing to give to the Jury the following instruction requested by the plaintiff in error:

“The plaintiff has not proved that there was any established license fee existing between him and the people of California during the time in which the defendant was either making, or using its fruit driers. He is therefore not entitled to recover any license fee as damages.”

28.

That the Court erred in refusing to give to the jury the following instruction requested by the plaintiff in error :

“Where the license fee or royalty is fixed by the patentee for a right to use all the inventions that are covered by all the claims of his patent in cases where the patent has more than one claim and it is shown that the defendant has infringed only a part of the claims of the patent in such case the plaintiff cannot recover as damages for the infringement of one claim the royalty or  
187 license fee which he has fixed as the price of the invention covered by all of the claims of the patent.”

29.

That the Court erred in refusing to give to the Jury the following instruction requested by the plaintiff in error :

“If the plaintiff sold the right to use the patented inventions while the patent had eight or more years yet to run at a given price, that fact does not of itself prove that he could sell the patented rights for the same amount in later years when the patent had less than one half as many years to run.”

30.

That the Court erred in refusing to give to the Jury the following instruction requested by the plaintiff in error :

“Where a part of the patented inventions only are used by an infringer the plaintiff is bound to prove the damages occasioned to him by the infringement, and if he fails to prove the amount of such damages by reliable testimony he can recover only nominal damages.”

31.

That the Court erred in refusing to give to the Jury the following instruction requested by the plaintiff in error :

“Where the patent is for an improvement, and not for an entirely new machine or contrivance, the patentee must show in what particulars his improvement has added to the usefulness of the machine or contrivance. He must separate his results distinctly from those of the other parts, so that the benefits derived from it may be distinctly seen and appreciated.”

188

32.

That the Court erred in refusing to give to the Jury the following instruction requested by plaintiff in error :

“The patentee must, in every case give evidence tending to separate or apportion the defendant’s profits and the patentee’s damages between the patented features and the unpatented features, and such evidence must be reliable and tangible, and not conjectural or speculative; or he must show, by equally reliable and satisfactory evidence, that the profits and damages are to be calculated on the whole machine, for the reason that the entire value of the whole machine, as a marketable article, is properly and legally attributable to the patentable feature.”

## 33.

That the Court erred in refusing to give to the Jury the following instruction requested by the plaintiff in error:—

“In this case it is admitted that the first claim of the patent was not infringed. As the plaintiff has not introduced any testimony tending to show what the value of the combination covered by the second claim was, nor any testimony tending to show the amount of any damages suffered by him by the infringement of the second claim, nor any data by which any such damages could be estimated, nor any established license fee or royalty for the use of the combination covered by the second claim he can recover nominal damages only for the infringement of the second claim of the patent.”

## 34.

That the Court erred in refusing to give to the Jury the following instruction requested by the plaintiff in error:—

“If the Jury find for the plaintiff on the other issues in the case they must find nominal damages only.”

## 189

## 35.

That the Court erred in giving to the Jury the following instruction during the course of the Charge to the Jury:

“If you find that the defendants have used all of these elements or their mechanical equivalents, combined together and accomplishing substantially the same result in the same way then they have infringed this claim, that is of course if you find that there has been an invention. If there has been no invention you do not reach that question.

When, in mechanics, one device does a particular thing or accomplishes a particular result, every other device known or used in mechanics which skillful and experienced workmen know will produce the same result, or do the same particular thing is a known mechanical substitute for the first device. It is sufficient to constitute known mechanical substitutes, that when a skillful mechanic sees one device doing one particular thing that he knows the other devices, with whose use he is acquainted, will do the same thing.”

## 36.

That the Court erred in giving the following instruction during the course of the charge to the Jury :—

“ If you find that the gravity catches of defendant do the same thing in substantially the same way as the spring catches of plaintiff, and that a skilled mechanic, upon seeing the spring catches work, would know that gravity catches would do the same thing in the same way, then the two are mechanical equivalents.”

## 37.

That the Court erred in giving the following instruction during the course of the charge to the Jury :—

190 When a patent is not for a mere form, the patentee is not required to claim his invention in all the forms in which it may be embodied. All that he is required to do is to describe and claim it in the best form he has contemplated using it, and having done that he will be protected in all forms by virtue of the doctrine of mechanical equivalents.”

## 38.

That the Court erred in giving the following instruction during the course of the charge to the Jury :—

190 “ If the patent shows that the plaintiff contemplated using gravity catches as well as spring catches and the two are mechanical equivalents, then it was not necessary for him to claim both forms, but when he claimed one form that included the other.”

## 39.

That the Court erred in giving the following instruction during the course of the charge to the Jury :—

“ The fact that in his original application plaintiff claimed as an element of his second claim spring or other catches and that he afterwards struck out the words ‘ or other ’, leaving the element simply spring catches, does not limit his claim to spring catches nor deprive him of gravity catches if the latter are mechanical equivalents of spring catches.”

## 40.

That the Court erred in giving to the Jury the following instruction during the course of its charge :—

“ If you find that the defendants have used all the specified elements of plaintiff’s second claim, except that they have substituted gravity catches instead of spring catches, and you further find that gravity catches do the same thing in substantially the same way as the spring catches, then defendants have infringed that claim.”

191

41.

That the Court erred in giving to the Jury the following instruction during the course of its charge:—

“If however you find from the evidence that plaintiff has established a fixed uniform royalty for the use of his invention by others, and has collected the same from other persons in several instances, then I instruct you that the said royalty is the proper measure of damages.”

WHEATON, KALLOCH & KIERCE,  
*Attorneys for Plaintiff in Error, and Defendant.*

(Endorsed :) Filed Jan. 18, 1892.

L. S. B. SAWYER,  
*Clerk.*

*Petition for an Order Allowing a Writ of Error.*

192 In the United States Circuit Court, Northern District of California.

JOHN W. CASSIDY,	Plaintiff,	} No. 11,361.
vs.		
HUNT BROTHERS' FRUIT PACKING COMPANY (a corporation),	Defendant.	

*Petition of Defendant for an Order Allowing a Writ of Error.*

The Hunt Brothers Fruit Packing Company, defendant in the above entitled cause, feeling itself aggrieved by the verdict of the jury, and the judgment entered on the 29th day of December, 1891, in pursuance of said verdict, whereby it was ordered, adjudged and decreed that the second claim of plaintiff's patent sued upon was good and valid in law, and that the defendant had infringed upon said second claim of said patent, and decreeing that the plaintiff have and recover of and from the defendant the sum of \$1350.00 damages with costs, comes now by Wheaton, Kalloch & Kierce it attorneys, and petitions said Court for an order allowing said defendant to prosecute a writ of error to the Honorable the United States Circuit Court of Appeals for the Ninth Circuit, under and according to the laws of the United States in that behalf made and provided, and also that an order be made fixing the amount of security which defendant shall give and furnish upon said writ of error, and that upon the giving of such security all further proceedings in this Court be suspended and stayed until the determination of said writ of error by said United States Circuit Court of Appeals for the Ninth Circuit.

193 And your petitioner will ever pray.

WHEATON, KALLOCH & KIERCE,  
*Attorneys for Defendant.*

(Endorsed :) Jan. 18, 1892.

L. S. B. SAWYER,  
*Clerk.*

*Bond on Writ of Error.*

194 Know all Men by these Presents, that we, Hunt Brothers Fruit Packing Company as principal, and Charles W. Pike and D. H. Porter as sureties, are held and firmly bound unto John W. Cassidy, in the full and just sum of Two Thousand Dollars, to be paid to the said John W. Cassidy, his certain attorneys, executors, administrators or assigns; to which payment, well and truly to be made, we bind ourselves, our heirs, executors and administrators, jointly and severally, by these presents. Sealed with our seals and dated this 18th day of January, in the year of our Lord one thousand eight hundred and ninety-two.

Whereas, lately at a Circuit Court of the United States, for the Northern District of California, in a suit depending in said Court, between John W. Cassidy, plaintiff (and defendant in error) and Hunt Brothers Fruit Packing Company, a corporation, organized and existing under and by virtue of the laws of the State of California, defendant (and plaintiff in error) a judgment was rendered against the said defendant (and plaintiff in error) and the said Hunt Brothers Fruit Packing Company have obtained from said Court a Writ of Error to reverse the judgment in the aforesaid suit, and a citation directed to the said John W. Cassidy is about to be issued, citing and admonishing him to be and appear at a United States Circuit Court of Appeals for the Ninth Circuit, to be holden at San Francisco, in the State of California.

Now, the condition of the above obligation is such, that if the said Hunt Brothers Fruit Packing Company shall prosecute its Writ of Error, to effect, and answer all damages and costs if it fail to  
195 make its plea good, then the above obligation to be void; else to remain in full force and virtue.

Acknowledged before me the day and year first above written.

L. S. B. SAWYER,

*Commissioner U. S. Circuit Court, Northern District of California.*

CHAS. W. PIKE. [SEAL.]

D. H. PORTER. [SEAL.]

United States of America, }  
Northern District of California. } ss.

Charles W. Pike and D. H. Porter being duly sworn, each for himself, deposes and says, that he is a householder in said district, and is worth the sum of Two Thousand Dollars, exclusive of property exempt from execution, and over and above all debts and liabilities.

CHAS. W. PIKE.

D. H. PORTER.

Subscribed and sworn to before me, this 18th day of January,  
A. D. 1892.

L. S. B. SAWYER,  
*Commissioner of U. S. Circuit Court, Northern District of California.*  
(Endorsed:) Form of Bond and Sufficiency of Sureties Ap-  
proved. (Signed) HAWLEY,  
*Judge.*

Filed January 18, 1892.

L. S. B. SAWYER,  
*Clerk U. S. Circuit Court, Northern District of California.*

*Certificate to Transcript.*

In the Circuit Court of the United States, Ninth Judicial Circuit,  
Northern District of California.

JOHN W. CASSIDY,	}	No. 13,361.
vs.		
HUNT BROTHERS FRUIT PACKING COMPANY.		

I, L. S. B. Sawyer, Clerk of the Circuit Court of the United States of America, of the Ninth Judicial Circuit, in for the Northern District of California, do hereby certify the foregoing 195 written and printed pages, numbered from 1 to 195 inclusive, to be a full, true and correct copy of the record and of the proceedings in the above and therein entitled cause, and the same together constitute the return to the annexed Writ of Error.

IN TESTIMONY WHEREOF, I have hereunto set my hand,  
[SEAL.] and affixed the Seal of said Circuit Court, this 9th day of  
March, A. D. 1892.

L. S. B. SAWYER,  
*Clerk U. S. Circuit Court, Northern District of California.*

*Writ of Error.*

UNITED STATES OF AMERICA, ss:

*The President of the United States,*

To the Honorable, the Judge of the Circuit Court of the United States for the Northern District of California, Greeting:

*BECAUSE*, in the record and proceedings, as also in the rendition of the judgment of a plea which is in the said Circuit Court, before you, or some of you, between Hunt Brothers Fruit Packing Company, plaintiff in error and John W. Cassidy Defendant in error, a manifest error hath happened, to the great damage of the said Hunt Brothers Fruit Packing Company, Plaintiff in Error, as by its complaint appears.

We, being willing that error, if any hath been, should be duly corrected, and full and speedy justice done to the parties aforesaid in this behalf, do command you, if judgment be therein given, that



then under your seal, distinctly and openly, you send the record and proceedings aforesaid, with all things concerning the same, to the United States Circuit Court of Appeals for the Ninth Circuit, together with this writ, so that you have the same at the City of San Francisco, in the State of California, on the sixteenth day of February next, in the said Circuit Court of Appeals, to be then and there held, that the record and proceedings aforesaid being inspected, the said Circuit Court of Appeals may cause further to be done therein to correct that error, what of right, and according to the laws and customs of the United States, should be done.

[SEAL.] Witness, the Honorable MELVILLE W. FULLER, *Chief Justice of the Supreme Court of the United States*, the 19th day of January, in the year of our Lord One Thousand, Eight Hundred and Ninety-two.

F. D. MONCKTON,

*Clerk of the United States Circuit Court of Appeals for the Ninth Circuit.*

Allowed by

THOMAS P. HAWLEY, *U. S. Judge.*

(Endorsed:) Service of the within Writ of Error and receipt of a copy thereof admitted this 20th day of January, 1892.

LANGHORNE & MILLER,

*Attorneys for Defendant in error and plaintiff.*

(Endorsed:) Filed January 20, 1892. L. S. B. SAWYER, Clerk U. S. Circuit Court, Northern District of California.

The Answer of the Judges of the Circuit Court of the United States of America, of the Ninth Judicial Circuit, in and for the Northern District of California.

The record and all proceedings of the plaint whereof mention is within made, with all things touching the same, we certify under the Seal of our said Court, to the United States Circuit Court of Appeals for the Ninth Circuit, within mentioned, at the day and place within contained, in a certain schedule to this writ annexed, as within we are commanded.

By the Court:—

L. S. B. SAWYER, *Clerk*

*Citation.*

UNITED STATES OF AMERICA, ss.

*The President of the United States, to John W. Cassidy, Greeting:*

You are hereby cited and admonished to be and appear at a United States Circuit Court of Appeals, for the Ninth Circuit, to be holden at the City of San Francisco, in the State of California, on the 16th day of February next, pursuant to a Writ of Error filed in the Clerk's Office of the Circuit Court of the United States for the North-

ern District of California, wherein Hunt Brothers Fruit Packing Company, is plaintiff in error, and you are defendant in error to show cause, if any there be, why the judgment rendered against the said plaintiff in error as in the said Writ of Error mentioned, should not be corrected, and why speedy justice should not be done to the parties in that behalf.

Witness, the Honorable Thomas P. Hawley, U. S. District Judge for the District of Nevada, assigned to hold and holding the United States Circuit Court for the Northern District of California, this 20th day of January, A. D. 1892.

THOMAS P. HAWLEY,  
*U. S. Judge.*

Service of the within Citation and receipt of a copy thereof admitted this 20th day of January, 1892.

LANGHORNE & MILLER,  
*Attorneys for Defendant in Error and Plaintiff.*  
(Endorsed:) Filed, January 20, 1892. L. S. B. SAWYER,  
*Clerk U. S. Circuit Court, Northern District of California.*

*Order Extending Time to Docket Case and File Record.*

In the United States Circuit Court of Appeals for the Ninth Circuit.

HUNT BROTHERS FRUIT PACKING COMPANY,	}
<i>Plaintiff in Error.</i>	
vs.	}
J. W. CASSIDY,	
<i>Defendant in Error.</i>	

Good cause therefor appearing, it is hereby ordered that the Hunt Brothers Fruit Packing Company, the plaintiff in error in the above entitled case, have an enlargement of the time, to and including the 16th day of March 1892, within which to docket said case and file the record thereof in the Clerk's Office of this Court.

THOMAS P. HAWLEY,  
*Acting U. S. Circuit Judge.*

(Endorsed:) Filed Feb. 15, 1892.

F. D. MONCKTON,  
*Clerk.*

No. 39.

---

IN THE

UNITED STATES CIRCUIT COURT OF APPEALS,  
FOR THE NINTH CIRCUIT.

HUNT BROTHERS' FRUIT PACKING COMPANY,  
*Plaintiff in Error,*

vs.

JOHN W. CASSIDY,  
*Defendant in Error.*

---

## Brief of Plaintiff in Error.

---

1  
true

M. A. WHEATON,  
I. M. KALLOCH,  
F. J. KIERCE,  
*Counsel for Plaintiff in Error.*

FILED

APR 22 1892



In the United States Court of Appeals for the Ninth Circuit.

HUNT BROTHERS FRUIT PACKING COMPANY,

*Plaintiff in Error,*

vs.

JOHN. W. CASSIDY,

*Defendant in Error.*

**BRIEF OF THE PLAINTIFF IN ERROR.**

This cause is brought to this Court by a writ of error, from the Circuit Court for the Northern District of California. The action was brought by the defendant in error to recover damages for an alleged infringement of U. S. Letters Patent No. 172,608, bearing date January 25, 1876, and granted to said defendant in error, John W. Cassidy, for alleged improvements in a drying apparatus. The pleadings are in the usual form. Notice of special matter was duly given by the plaintiff in error.

The action was tried by jury. A verdict was rendered for the plaintiff in the case, John W. Cassidy, for the sum of thirteen hundred and fifty dollars, and judgment was entered thereon in the said Cassidy's favor.

In this brief we will call the said Cassidy "plaintiff" and the Hunt Brothers Fruit Packing Company "defendant," as they were in the Court below.

On the trial four witnesses were called by the plaintiff and testified in the case. There was also introduced in evidence the patent sued on and also models of fruit dryers.

The plaintiff then rested his case and the defendant asked the Court to instruct the jury to bring in a verdict for the defendant. The Court overruled the motion and the defendant excepted. Eight other exceptions were taken during the trial by the defendant. Some of them were on account of the admission of testimony that the defendant objected to; and some were taken on account of the refusal of the Court to allow certain questions to be asked witnesses.

Our assignment of errors is in the Record, from page 122 to page 132.

Each assignment of error is based upon an exception that was taken during the trial, and which is contained in the bill of exceptions. The assignment of errors therefore may be referred to as showing the exceptions in the case. This will be most convenient,

as many of the exceptions often refer to one subject and they can be grouped under a few heads, and each group discussed under the single heading to which it belongs; and the argument thereby shortened.

The exceptions shown under assignment of errors, from ten to thirty-four, inclusive, were all taken on account of the refusal of the Court to give instructions asked for by the defendant.

The exceptions taken, which are shown under assignment of errors, from number thirty-five to number forty-one, both inclusive, are all based upon instructions which were given to the jury against the objections of the defendant. Only forty-one exceptions were taken.

### ARGUMENT.

The first exception was taken to the ruling of the Court in permitting the plaintiff to give his opinion as to the relative cost between his patented fruit dryer and the old Alden fruit dryer. The witness had already stated that he did not know what the Alden dryer cost and he could only give an opinion.

If the cost of the Alden dryer was admissable at all it was a fact that was capable of positive proof, and it was not proper to allow a mere opinion to be given by a mechanic who had never built one of them.

The next exception is one of much more importance. At the close of the plaintiff's opening testimony and after he had rested his case, the defendant asked for an instruction that the jury should bring in a verdict for the defendant, which motion was denied.

Giving such an instruction is the method used in the U. S. Courts for ending a case when the plaintiff's own testimony shows that he is not entitled to a verdict even though every fact which he has undertaken to prove should be true. It is equivalent to the ordinary motion for a non-suit in the State Courts.

The testimony of Mr. Cassidy showed that his drier operated substantially the same as the old Alden drier which he had seen before he made his alleged invention. That the difference between them was in the mechanism by which their operations were carried on. We claimed then and claim now that this testimony showed as a fact that the change which the plaintiff had made was not any change in the operation of the Alden drier, but that at the most he had only substituted equivalent mechanical devices for those which had already been doing the same work in the Alden drier.

We base this point upon the ground that the plaintiff's own evidence proved that the patent was invalid; and that as the patent was invalid no action could be maintained upon it.

This ground applies to the second claim of the patent only. The patent has two claims, but there was no proof of any infringement of the first claim and it has been conceded all the way through the

case that the defendant had not used any thing covered by the first claim and had not infringed the same. The whole struggle in the case is and has been over the second claim.

Our assertion that the plaintiff's own evidence proved that the patent is invalid as to the second claim is based upon one well defined rule of patent law, and upon the undisputed testimony of the plaintiff himself, corroborated, however, by other evidence.

The principal fact referred to is this, viz.:

Prior to the alleged invention of the plaintiff he had seen and knew the construction of a well-known fruit drier that was already in public use known as the "Alden Drier." That this Alden drier operated upon the same mechanical principle as did the plaintiff's drier, and contained devices for performing precisely the same operations as did the plaintiff's drier. That all the plaintiff did was to take the Alden drier and change it by taking out certain chains and lugs that were used for receiving and carrying upwards through the heated draft trays which carried the fruit that was being dried and delivering the same at the top of the drier, and substituting for such chains and lugs the stationary and movable posts with the spring catches, the combination of all which is covered by the second claim of the patent.

That the alleged invention therefore consisted solely in substituting for the chains and lugs of the Alden drier the mechanical equivalents of such chains and lugs which were used for producing precisely the same effects and results and none other than the chains and lugs of the Alden drier produced.

The rule of law referred to is this, viz.:

The substitution of mechanical equivalents for the devices or elements that are already in use in an existing combination of devices, whether such substituted devices produce better results or not, is but the exercise of mere mechanical skill, and is not patentable. This is a rule that has been declared and repeated and reiterated in a large number of cases by the U. S. Supreme Court.

In *Smith vs. Nichols*, 21 Wall., on the first half of page 119 the Supreme Court says:

"But a mere carrying forward or new or more extended application of the original thought, a change only in form, proportions, or degree, *the substitution of equivalents, doing substantially the same thing in the same way by substantially the same means with better results*, is not such invention as will sustain a patent. These rules apply alike, whether what preceded was covered by a patent or rested only in public knowledge and use. In neither case can there be an invasion of such domain and an appropriation of any thing found there. In one case every thing belongs to the prior patentee, in the other to the public at large."

This rule of law has been repeated and reiterated by the Supreme Court time and time again as well as by many of the Circuit Courts.

*Roberts vs. Ryer*, 91 U. S., 159.

*Reckendorfer vs. Faber*, 92 U. S., 354.

*Penn. Railroad vs. Locomotive Truck Co.* 110 U. S., 494.

*Phillips vs. Detroit*, 111 U. S., 607.

*Morris vs. McMillin*, 112 U. S., 249.

*Stephenson vs. Brooklyn Railroad Co.*, 114 U. S., 154.

*Dunbar vs. Myers*, 94 U. S., 199.

*Burt vs. Ivory*, 133 U. S., 358.

*International Tooth Crown Co., vs. Gaylord*, 140 U. S., 62.

*Butler vs. Steckel*, 137 U. S., 29.

In consulting the foregoing cited cases as many illustrations of what facts the foregoing rule of law will apply to, will be found as the Court will care to examine. The foundation principle of it all is, that the knowledge belonging to existing mechanical skill belongs to the public and every mechanic, as well as the public has the right to use it, and no one mechanic, or any one else can deprive other mechanics or other persons from using what belongs to them, by obtaining patents for specific variations of mere mechanical skill which variations includes nothing but what any skilled mechanic knew how to make by applying to the subject his mechanical knowledge only, and without any exercise of the inventive faculty. Any mechanic knows how to make mechanical implements in many forms and when he intends to make any given implement in a new form he knows before he makes it what it will do because its new form is analogous to other forms already known and the change of form will produce only the change in result that the same change of form has produced in other well known implements. The same is true of combinations of devices. When a mechanic sees a machine at work and sees the various devices of which it is comprised, and sees what duty each device performs and how it performs it, and also sees the ultimate result of all the devices working in combination, he at once knows that he can substitute many other mechanical devices for those in the machine and produce the same results and by the same mode of operation. If he wishes to make a cheaper machine his knowledge of mechanics enables him to do it without any invention. If he wishes to make a stronger machine of the same kind he may substitute better materials or even better devices for doing the same corresponding work that one or more of the devices in the machine is doing and thus make a stronger machine because he already knows how to do it by using his knowledge of mechanics only. If he wishes to make a faster working machine his knowledge of mechanics enables him to do that without any invention because he already knows how. Making such changes by using only the existing knowledge and skill of mechanics does not constitute invention. It is different, however, if he makes an improvement that does involve invention, something



that the existing knowledge and skill of mechanics cannot reach without climbing higher than the present plane of existing mechanical skill and knowledge and discovering and using something, or creating something, that no one had before known how to make.

That the substitution of well-known devices for the devices in an existing machine and thereby obtaining the same result in kind, still leaving the machine doing the same work that it did before and doing it in the same way without any change in its ultimate results and with no change in its internal operations other than what would necessarily follow from the different operations of the substituted devices, and which different operations it was known would necessarily follow because of the different action of the substituted devices does not amount to invention, and a patent for so doing is invalid, and no action can be maintained for the infringement of such a patent. As for instance, a mechanic knows the operation of a lever and he knows the different actions of a wheel and axle. If he sees a combination of devices in which a lever is used, and in which a wheel and axle can be substituted, he knows at once that he can make the substitution; and he knows in advance that the combination will do the same work and produce the same result after the wheel and axle has been substituted that it did before, and he knows that the general operation of the machine will be the same as it was before, and that its internal operations will be changed somewhat because the operations of the wheel and axle which he has substituted is different from the operations of the lever for which it was substituted. Still he can make the change, using only his knowledge and skill as a mechanic, and without inventing anything. It is a common mode of attempting to appropriate the invention of real inventors by making mere mechanical changes in the forms of their machines and then claiming that they are not the same.

Now in the case at bar, before the plaintiff made any invention, he, the plaintiff, had seen the Alden drier; he had seen the trays of fruit put in at its bottom; he had seen those trays rise as required during the process of drying; he had seen that as fast as the lower one rose high enough to give the room that another one was put in its place on the lugs that the chain carried; he had seen that when the drier was filled with the trays of fruit that the tray of dry fruit at the top was taken out and the column of trays raised by the chains and lugs and another tray of green fruit put in at the bottom and that the drier was thus constantly kept full and the dried fruit taken from the top of the drier and the fresh undried fruit placed in the bottom. This mode of operation he did not change, *but appropriated it bodily.*

In appropriating the general plan and mode of operation of the machine, the only change made by him so far as the second claim

applies, was to substitute for the chain and lugs of the Alden drier the stationary and movable posts and spring catches of his patent.

In *Randall vs. B. & O. R. R. Co.*, 109 U. S., 482, the Supreme Court says :

“ It is the settled law of this Court, that when the evidence given at the trial, with all inferences that the jury could justifiably draw from it, is insufficient to support a verdict for the plaintiff, so that such a verdict, if returned, must be set aside, the Court is not bound to submit the case to the jury, but may direct a verdict for the defendant. *Pleasants v. Fant*, 22 Wall., 116 ; *Herbert v. Butler*, 97 U. S., 319 ; *Bowditch v. Boston*, 101 U. S., 16 ; *Griggs v. Houston*, 104 U. S., 553 ; Robinson on Patents, Sec. “ 1073.”

*Heald vs. Rice*, 104 U. S., 737, was a patent case that was tried by a jury. Many of the facts are stated in the opinion of the Supreme Court in deciding the case. On pages 737 and 738, the Court states the fact, that :

“ A bill of exceptions sets out the exceptions of the defendant to the rulings of the Court below, and all the evidence. The Court was asked at the close of the plaintiff’s testimony, and again when all the evidence on both sides had been introduced, to instruct the jury to return a verdict for the defendant; the refusal to do, which, amongst other rulings, is assigned for error; and thus the whole case on the merits is brought here for review, so far as they rest upon questions of law.”

The case at bar is in the same condition as was the case of *Heald vs. Rice*, and that, at the close of the plaintiff’s opening testimony the defendant asked for an instruction that the jury bring in a verdict for the defendant, and the Court refused the request. There was no subsequent testimony that made the plaintiff’s case any better for him than it was when he closed his opening testimony.

In the *Rice* and *Heald* case, exceptions were argued under three heads, and the second one of them was in effect that the testimony showed that the invention was anticipated by a former patent to one Morey. (See page 748 of the decision.) On page 753 of the decision, the Supreme Court proceeds to show that the Morey patent was, in fact, an anticipation of the *Rice* patent sued on. At the close of its decision in that case, the Supreme Court says :

“ The Court below, in its rulings upon objections to the introduction of the reissued patent of *Rice*, in its refusal to charge the jury as requested by the defendant, and in its charge as given, took views of the validity of the patent, on which the case of the plaintiff rested, which are opposed to those expressed in this opinion, and which necessarily resulted in the verdict and judgment against the defendant. For these errors the judgment must be reversed, with directions to grant a new trial; and it is so ordered.”

The case of *Fond du Lac County vs. May*, 137 U. S., 395, was a

case that was tried by a jury and taken to the Supreme Court on a writ of error. In that case, also, the defendant moved that a verdict be directed for it, which motion was made upon the ground that the patent was void for lack of novelty, and that the combinations described in it were not operative combinations and were old and well-known devices applied to similar uses. The motion was overruled and the defendant excepted. In its decision, the Supreme Court *examined the facts* of the case and decided that the patent was void. Page 402 of the case shows that the instructions were asked for and refused. On page 403, the Supreme Court says:

“ We are of the opinion that the *Court ought to have directed a verdict for the defendant, on the ground that the patent was void*; and “ that the judgment must be reversed.”

The next case in the same volume is *May vs. Juneau County*. It was another suit at law brought upon the same patent.

At the close of the testimony the defendant moved for an instruction to the jury to bring in a verdict for the defendant upon *other grounds* than that the patent was void. The Court granted the motion and the plaintiff carried the case to the Supreme Court on a writ of error. The Supreme Court affirmed the judgment and held that the Court was right in giving the instruction *because*, as the Supreme Court held, *the patent was void*. That although the instruction was not asked for upon that ground, still the *defendant could urge that ground at any time* and the motion was broad enough to cover the invalidity of the patent although that ground was not then distinctly urged. That “want of patentability is a defence “ though not set up in an answer or plea.” Citing several of its own decisions.

Our object in referring to these authorities is to prove that when the testimony shows that the patent is invalid and the trial Court is asked to charge the jury to find for the defendant that it is error for such Court to refuse the instruction, and that the appellate Court will reverse the judgment entered in the plaintiff's favor in such a case and order a new trial.

We also claim that when the testimony is construed as strongly as possible in the plaintiff's favor and every fact which he undertakes to prove is taken to be true, if then the evidence proves the patent to be invalid, that the applying of the facts to the patent becomes a question of law, and if the lower Court refuses to do so and declare the patent void, when the undisputed facts so show it, that such refusal is an error for which the appellate Court will reverse the judgment and grant a new trial.

Believing that we have established this proposition by the authorities we will return to the presentation of the evidence and see whether or not the evidence in the case at bar does show the patent invalid so as to bring the case within the decisions to which we have referred.

The plaintiff's patented drier is built and operates as follows :

It has four stationary posts, one at each corner of the machine. It also has four movable posts, one of which is alongside of each one of the stationary posts. All of the posts are in a vertical position. A series of spring catches, one at some distance above the other, is fixed to each one of the posts. The upper end of these spring catches extend out from the posts so as to furnish a support for the fruit trays that are used to carry the fruit that is being dried.

The catches are pivoted so that they will turn back along the side of the post to which it is fixed and so allow an ascending fruit tray to pass it. The catches are fixed to the four stationary posts level with each other so that each set of four catches that are on the four posts will be level with each other and they will furnish a support for each tray near each corner of the drier. The catches are arranged the same way in the movable posts. Mechanism is employed to move the four movable posts simultaneously up and down far enough to carry each fruit tray upwards from one set of catches and deposit it on the next set of catches above, and then return for another tray.

The operation of the drier is as follows: A tray of fruit is set on the lower set of catches on the movable posts. The posts are raised and the spring catches in the stationary posts will be pressed back by the edges of the rising tray. When the rising tray that is carried upward by the movable posts reaches a point level with the upper ends of the set of catches in the stationary posts those catches will spring forward so that their upper ends will come underneath the tray and furnish a support for it to rest upon. The movable posts will then return downwards and receive another fruit tray. While the movable posts are returning downwards their second set of catches above will fall back so as to pass the edges of the tray that was first carried up, and will then spring forward so as to furnish supports for the tray when the movable posts are again raised. The movable posts will then be raised and the two trays will then be carried upward far enough for each one to pass one set of the catches in the stationary posts when the trays will be supported by them as the movable posts are again moved downwards to receive another tray. This operation will be repeated until all the catches on the stationary posts are filled with the trays. The operation will be carried on slowly enough to allow the fruit in the upper tray to become thoroughly dried when it reaches the top of the drier where it will be removed from the drier. As fast as the trays are removed from the top of the drier other trays of fresh fruit are replaced in the bottom, and the drying operation is continued as long as desired. This class of driers have been denominated "stack" driers.

The plaintiff testified that he was a mechanic and had formerly lived in Wayne county, New York. That he had been in mechanics

since he was fourteen years old, working with his father. His father was a mechanic and he worked with him a good many years. He worked as a mechanic in New York, and at the Golden State and Mners' Foundry in California, and also at the Vulcan. Record, side page 21.

His age was sixty-nine. He came to California in 1852, and had lived in Petaluma since 1858. He came from Wayne County, N. Y. In that county there was no fruit drying except by the sun. Record side pages 15 and 16.

The plaintiff himself testifies that the Alden drier was the *first* drier of the kind and that he saw it and it operated in carrying the trays up and in drying the fruit the same as did his own drier. Beginning at the middle of page seventeen of the Record his testimony is as follows:

“The *first fruit drying machine* where the trays of fruit were put “in at the bottom and carried gradually to the top, one above “another, *was the Alden machine*. I saw that in 1874 or 1875, “somewhere about that time.

“Q. What is the difference in operation between that machine “and yours?

“A. I think I can explain this thing with this model, plaintiff's “Exhibit No. 2. I suppose you all know what an endless chain is. “It is formed by links, and these flat links are fetched together and “run over pulleys or sprocket wheels as this endless chain comes “up. They are far enough apart to keep the trays separate. There “would be an arm to each one of those links. As it comes up on “the sprocket wheel they would be four square or six square or “eight square, wide enough to accommodate the link. The sprocket “wheel is where the endless chain runs over at the top and one “corresponding at the bottom. As these links come up there is a “projection on the link that comes through, perhaps a couple of “inches, to receive the tray as you insert it. As you put that in “with mechanism, those chains all move together. There is a “chain on each one, so that when you apply the mechanism, each “chain moves in unison. As the next link comes around, you put “in another tray and continue until it is full.

“A JUROR. Q. These arms of the chain would project out?

“A. Yes sir, and that would hold the tray until it got to the “top, and the tray then would be removed before it struck the “sprocket wheel. When it struck the sprocket wheel one portion “of the chain would be going down outside while another portion “would be coming up inside. That is the way the Alden machine “is operated.

“MR. WHEATON. Q. So far as drying the fruit is concerned, “and the movement of the tray is upwards, what is the difference “between the Alden machine and your machine?

“A. *It would be the same*. I will not say the movement of dry-

“ing would be the same. The movement is different.

“Q. I speak of the movement of the tray alone. *Would they not move up the same in one case as in another (the other) provided the machine was worked at the same rate of speed and same intervals of time?*

“A. *Yes, sir.*

“Q. The trays would be carried up *just the same* in one machine as they could in another (would in the other)?

“A. *Yes, sir.*

“Q. In neither case are the trays constantly moved up, but are carried up step by step, and allowed to remain there until the fruit is dried awhile, and the bottom one taken out, refilled, and put in at the bottom and carried up another step until the next one is sufficiently dried to remove?

“A. Yes, sir. Between the times of movement of the machine to carry a tray up one step from fifteen minutes to half an hour intervene, owing to the variety of fruit and the amount of heat.

“Q. Are the furnaces in the Alden machine capable of being arranged as in your machine?

“A. I don't know; the furnace certainly is at the bottom, but what kind of a furnace they use I don't know.

“Q. What other drying machine of this stack, or capillary kind, is there that you know of?

“A. That is the only one I ever saw outside of mine, at that time. I have since seen them with those gravitating catches, but not before. The Alden machine is the only machine that I saw outside of mine.

“Q. Would you not understand that your invention was to substitute this kind of movable posts and these catches for the endless chain of Alden for the purpose of carrying up those fruit trays?

“A. I did not so intend it. I intended to carry up my fruit trays by those springs, without any regard to what Alden or any one else did.

“Q. Did you make any other change at that time that you can think of in fruit trays, so far as the second claim of your patent is concerned, other than to substitute this kind of catches and posts for the endless chain with the arms on, which are used in the Alden drier?

“A. I have no recollection of ever having made any change from what you see here.

“Q. What change did your invention make in fruit driers?

“A. It had a tendency of rather revolutionizing the fruit drying business, for immediately after I got my patent most every one was using these devices East. They were using my catches and sliding posts. *The Alden had the name of being a well-known and celebrated fruit drier. My drier would dry the same as the Alden. I don't suppose it would dry any different kind of fruit. I don't think*

“ it would dry it in any different manner.”

On pages 23, 24, 25 and 26, his testimony is even still stronger than that just quoted, in showing that his posts and spring catches are but the mechanical equivalents of the Alden chains and lugs. *They both did the same kind of work ; they both did it the same way—* that is, by receiving the loaded trays in the bottom of the driers, one at a time, and carrying them to the top at any speed desired and with any stoppages which the operator chose to make—*one would do everything that the other would do, and neither would do anything that the other would not do.* On page 24, the plaintiff’s testimony is strong in showing that his posts and catches fill every one of the legal requirements that made them the mechanical equivalents of the chains and lugs of the Alden drier.

Near the bottom of page 20 of the Record, Mr. Cassidy testifies that he saw five of the Alden machines in operation in San Lorenzo in 1874. A man named Pile had charge of the Alden drier in California, and he went East in 1875.

The plaintiff’s patent was applied for March 8th, 1875. (See heading of the patent, Record, page 9.)

On pages 82 and 83 of the Record, Mr. Cassidy puts in a crude drawing and says that he made it and got up that idea about the latter part of March or first of April, 1874.

Other patents of stack driers of much older date were put in evidence by the defendant, but there was nothing put in evidence that tended to contradict, or in any way relieve the legal effect of the plaintiff’s testimony, which was, that the *Alden was the first* drier, and that the plaintiff had seen it before he made his invention, that it “ *was a well-known and celebrated drier,*” and that it operated the same as did the plaintiff’s dryer in receiving the fruit trays, in carrying them upwards, and in drying the fruit upon them.

We submit to the Court whether the facts of this case does not exhibit an effort on the part of the plaintiff to *appropriate bodily* the principle and mode of operation of the Alden drier and claim it as his own, and that the substitution of the posts and catches for the chains and lugs of the Alden drier, and the obtaining of his patent, therefor were not the means by which he has attempted to make such appropriation. In the Record from page 11 to page 16, he has described the operations of the devices in his driers just as though those operations were original with him instead of being taken from the Alden machiné, and when in addition to this, we look at his answer on page 18, given in answer to the question as to whether his invention was not the substitution of the posts and catches for the endless chain of the Alden drier, he says: “ I did not “ so intend it. I intended to carry up my fruit trays by those “ springs, *without any regard to what Alden or anyone else did.*” Is it not plain that his effort is to appropriate to his exclusive use and as his exclusive property the prior inventions of others which he

found in use and which were no part of his discovery. While he lived in Wayne County, although he was a mechanic, he did not think of making fruit driers. After he found the Alden driers at work in California, he substituted the posts and catches for the Alden chains and lugs "without any regard to what Alden or any one else did," and then sent his agent back to that same Wayne County, and put his drier which was substantially the same thing as the "well-known and celebrated" Alden drier, and charged one hundred dollars royalty for what he had thus *found and appropriated* in California, "without any regard to what Alden or any one else did."

Applying to these undisputed facts the rule of law which we have shown to be established by so many decisions of the Supreme Court to the effect that the mere substitution of mechanical equivalents for devices already used in an existing machine is not invention, and that a patent granted for the same is totally invalid; and applying also the other rule that when all the facts in the case proved that the plaintiff's patent was invalid that it was the duty of the Court to instruct the jury to find a verdict for the defendant, and we cannot see why our second exception is not fatal to the plaintiff's case.

We think that we have shown to a mathematical certainty that, taking all of the testimony that is in the case in the plaintiff's favor as true, the fact is established that the patent was totally invalid and that there was no question except to apply the facts to the plaintiff's patent and decide that, as a question of law, those facts made the patent invalid; and that under such circumstances it was the duty of the Court to direct the verdict as asked for by the defendant. While we do not intend to waive any of the exceptions between the second and tenth we will not stop to make an argument upon them. We consider that the instructions present substantially the same questions, and will pass to the instructions.

In discussing the foregoing second exception we had to assume that every fact was as the plaintiff claimed it to be so as to leave nothing for the jury to pass upon. In discussing the charges that were given or refused no such assumption exists. The giving or refusing of instructions is based upon the idea that the jury are to decide upon the testimony and find what the facts are and that the charges guide them in applying the law to the facts as they shall find them to be and, from such application, to reach a correct ultimate conclusion.

The defendant introduced in evidence a patent to M. P. Smith that was granted in 1870 for a stack drier that received the fruit trays at the bottom and carried them to the top, and, as we claimed, operated on the same principle as the plaintiff's stack drier. At the four corners of the Smith drier there were four vertical screws which did the lifting of the trays. These screws had very wide



threads cut in them and the ends or edges of the fruit trays reached into these threads and the trays were carried upwards as the screws were revolved. When the drier was filled with trays, the top tray would be removed and a fresh tray put in at the bottom and the work carried on in that way.

Defendant claimed that the posts and catches of the plaintiff's drier were but mechanical equivalents of the four corner screws of the Smith drier.

This Smith patent is shown and explained in the Record from page 51 forward. Its drawings are between pages 50 and 51.

The defendant also put in evidence a patent granted to Foote and Smith on the 26th day of March, 1872. This patent described a drier that was like the Smith patent for receiving and carrying the fruit trays, but its furnace and draft arrangements were such that the heated air passed downwards through the drier instead of passing upwards as in most other stack driers. Record pages 76 to 80.

Defendant also put in evidence a patent granted to Alfred Edwards on the 7th day of January, 1873. This was also a stack drier. It had four endless belts, one at each corner. Arrangements shown as projections in the drawings were attached to the belts for receiving the trays, which were called *plates* in the patent. These were projections reaching out from the belts at intervals similar to the lugs of the chains in the Alden drier. In this Edwards patent the plates carrying the fruit were placed in at the *top* of the drier and *carried downwards against the draft of heated air*.

It will be noticed that every one of the last three patents were for stack fruit driers. In two of them the fruit trays were received at the *bottom*, one at a time, and were carried upwards and more trays put in at the bottom until the stack was filled. In these two each tray was put in at the bottom and taken out at the top. In these two the trays were carried upwards the same as they are carried upwards by the plaintiff's drier, and were so carried up by devices of which, defendant claimed, the plaintiff's posts and catches were equivalents only. In one of them the draft was upwards the same as in the plaintiff's, while in the other one the draft was downwards. In the third patent were the four belts, which evidently could be run either up or down, but were described as running downwards. This was also a stack drier but it *carried the fruit trays downward* against the draft of heated air.

It will be noticed that each one of these three driers were several years older than even the crude sketch that was made by the plaintiff in 1874, and that in these three driers were found the general combinations of the plaintiff's drier made up of devices of which the plaintiff's posts and catches were only mechanical equivalents. Also, that every principle and mode of operation was incorporated in these driers and in their action that can be found in the plaintiff's

iff's drier, *and considerable more*. In addition to the mode of operation shown in the plaintiff's drier, there was found in one or other of the said three driers a *downward draft of hot air*, and in another a *downward movement of the fruit trays* against the rising draft of heated air.

Even without counting the Alden drier there was nothing left for the plaintiff *to invent* when he commenced in 1874. All that he could do was *to appropriate* what then belonged to prior inventors or to the public. No mode of action is found in his machine that was not in operation long before in some one of the last three patents mentioned. Nothing new is shown in the plaintiff's patent *except the substitution of mechanical equivalents* for doing the same work that other mechanical devices had long before been doing in earlier machines. At least, this is what the defendant claimed the proof established, and it had good reason to so claim.

Besides the three patents last mentioned, the defendant put in evidence a patent that was granted to J. O. Button for a stack fruit drier. This patent was applied for July 20th, 1874, and was granted September 22nd, 1874.

This Button patent was issued between five and six months before the plaintiff's patent was applied for. The Button patent was applied for more than seven months before the plaintiff's patent was applied for. Considerable testimony was taken showing that the Button machine was made to operate the same as the plaintiff's except when one tray was lifted up from the bottom and deposited upon the catches above and the next tray was put in under it and lifted up to the same catches that the upper tray from that time forward rested upon the lower tray and was carried up by it. When the stack was full in the Button drier, the trays rested one on top of the other except at the bottom where next to the lowest tray rested upon a system of catches which were spring catches like the plaintiff's. The trays were moved upward by a lever arrangement that lifted the bottom tray and placed it on the catches above so as to make room for the next tray, the operation so far being the same as in the plaintiff's drier. (See evidence on pages 70, 71, 72, 88, 89, 90, 95, 96, 97, and description in Button patent on page 64.

Even the plaintiff's own expert testifies that the lower part of the lower catches of the Button patent were substantially the same as the spring catches of the plaintiff's patent. Upon this fact we do not understand that there was any dispute or any conflict in the testimony. This left the plaintiff anticipated even as to the catches themselves; and although there were not so many of them, as are shown in the drawings of plaintiff's patent. We claimed, however, that as there were enough of them to raise the lower trays of fruit one step high, that all the plaintiff did over what Button did was to put in more sets of the catches for the purpose of making them *repeat* the same kind of operation; and that this was not and

could not be a patentable invention. If this was so it left the plaintiff with nothing new even in his substitution of mechanical equivalents.

The foregoing questions were questions that we claimed should have been left to the jury to decide and that they should have had proper instructions, so that when they had concluded as to the disputed facts that they could correctly apply the law to those facts and reach a correct conclusion in their general verdict.

We here call the attention of the Court to the second claim of the plaintiff's patent and ask it to say whether more than one set of stationary catches and one set of movable catches are called for by the claim. Of course we admit that these eight catches are necessary for receiving the tray and carrying it up one step and leaving it deposited in its position one step upwards. These eight catches are all that are used in this one operation, and they are all that the terms of the claim require. Now suppose the patent to be valid and the drier to have been the first of its kind, would not the claim be infringed by a drier that contained the stationary posts, the movable posts, with four catches on the stationary posts and four on the movable posts? The tray would be received on the catches on the movable posts and carried up above the catches on the stationary posts and left there as the movable posts returned down to receive another tray. If one full double set of these catches does not fill the calls of the claim how many set would it require? Would a person have to use twenty sets, or ten sets, or five sets before he would infringe? Since no number is stated in the claim other than one double set of eight catches, and as that number performs one of the entire operations that is performed by the catches, no matter how many are used, we believe that the claim of the patent is filled by that number of catches, and that if the patent is valid that any person using that number of catches with the several posts called for would infringe the patent. If this is so then the Button patent was a full anticipation of the plaintiff's patent.

The defendant also introduced in evidence the file wrapper contents of the Patent Office, showing the Record of the proceedings had in, and upon, the plaintiff's application for his patent. This is in the Record from page 31 to the top of page 41.

As plaintiff first asked for his patent he, in his second claim asked for the combination "with the spring or other catches," etc. The Patent Office rejected the claim and referred to the Button patent as anticipation of it. These things appear on page 34 of the Record.

The plaintiff then amended his application and changed the second claim by leaving out the words, "or other catches," and asking for the spring catches alone.

Now this is one of the cases where the field was covered before the plaintiff got into it. There was very little left, if anything, for him to

invent. Every thing in his second claim was already in use, even his springs. He accepted his patent with the words, "or other catches," erased, not because he did not want them but because the Patent Office said they did not belong to him, and the Patent Office refused to allow them to him. The Supreme Court has decided in very many cases that in such instances the patentee cannot accept his patent with things stricken out of what was in his application and then afterwards come into Court and claim the things thus stricken out of his application and have them allowed to him by the Court, either upon the ground that they are mechanical equivalents of what was allowed to him or on any other grounds.

In *Shepard vs. Carrigan*, 116 U. S., beginning on page 597 the Supreme Court says:

"This fact, and the file wrapper and contents of which we have stated the substance, make it clear that the claim and specification of the McDonald patent must be construed to include, as their language requires a fluted or plaited band or border as one of the essential elements of the invention. *Without this element the patent would not have been issued.* The Patent Office decided that without it the invention had been anticipated. Where an applicant for a patent to cover a new combination is compelled by the rejection of his application by the Patent Office to narrow his claim by the introduction of a new element, he cannot after the issue of the patent broaden his claim by dropping the element which he was compelled to include in order to secure his patent." Citing a list of authorities.

So in *Sargeant vs. Hall Safe and Lock Co.*, 114 U. S., on page 86, the Supreme Court says:

"In patents for combinations of mechanism, limitations and provisions, imposed by the inventor, especially such as were introduced into an application after it had been persistently rejected, must be strictly construed against the inventor and in favor of the public, and looked upon in the nature of disclaimers."

See also

*Legget vs. Avery*, 101 U. S., pages 258, 259 and 260.

*Mahn vs. Harwood*, 112 U. S., page 359.

*Cartridge Co. vs. Cartridge Co.*, 112 U. S., page 644.

*James vs. Campbell*, 104 U. S., page 378.

*Goodyear Dental Vulcanite Co. vs. Davis*, 102 U. S., page 228.

*Sutter vs. Robinson*, 119 U. S., page 541.

*Burns vs. Meyer*, 100 U. S., latter part of page 672.

*Crawford vs. Heysinger*, 123 U. S., pages 606 and 607.

Our position is that under these authorities the plaintiff cannot claim as elements of his combination any catches except *spring* catches. Under the rejections of his application for a patent by the Patent Office he struck out the words, "or other catches," and by so

doing obtained his patent. He cannot now come into Court and claim what *he thus struck out of his claim*.

Of course we do not pretend but that the gravity catches are the equivalents of spring catches. The real points are two; one is that the plaintiff cannot cover equivalents of the elements of his combination for the reason that all that he did himself was to substitute his particular devices for other devices which he already found in the same kind of combination. The same combination with other equivalent elements *already existed and he did not invent it*. His claim therefore must be limited to his particular devices because *that is the extent of the change he made*. The original inventor of the combination could invoke the doctrine of mechanical equivalents, but a mere improver who only changes the devices is not an original inventor of the combination and he cannot claim equivalents of the elements. Those equivalents *belonged to the first inventor and not to the improver*.

This whole subjected is treated at great length in *Morley Machine Co. vs. Lancaster*, 129 U. S., from page 272 to 283, where the authorities are presented in the opinion of the Supreme Court.

*McCormack vs. Talcott*, 20 How., page 405.

*Railway Co. vs. Sayles*, 97 U. S., page 556.

*Grier vs. Wilt*, 120 U. S., was a decision on a fruit drying patent, and is interesting as showing how a narrow patent is to be construed.

Our other real point referred to is that as the defendant only substituted one class of devices for another class in a known combination of devices, such substitution could not constitute a patentable invention, and the plaintiff's patent *is void* on that account. That it cannot be sustained even by giving it a very narrow construction and limiting it to spring catches as contradistinguished from other catches. This point is covered by the authorities already cited, which hold that the mere substitution of mechanical equivalents does not amount to a patentable invention, even though better results are obtained by such substitution.

There is one feature of this case that is reached by the decision of the Supreme Court in *Railroad Co. vs. Mellon*, 104 U. S., 112.

In both cases the applicant filed his specifications with a certain claim that would suit the description as contained in the specifications filed. In both cases the Patent Office refused the claim and after the claim was changed so as *not to fit the description*, the patent issued leaving in the specifications the original description. In both cases, the patentee claimed according to the original description, which the claim no longer fitted except by "construction." In the case referred to, 104 U. S., on page 118, the Supreme Court says :

“ In this case the *description* of the appellee’s invention is much “ *brouder than his claim*. It seems quite clear from the present “ form of his specification, and from the fact that his application “ for a patent was twice rejected, that he was compelled by the “ Patent Office to narrow his claim to its present limits before the “ Commissioner would grant him a patent. In doing this, he “ *neglected to amend the descriptive part of the specification*. He cannot “ go beyond what he has claimed and insist that his patent covers “ something not claimed, merely because it is to be found in the “ descriptive part of the specification.”

The change made in the claim in the case cited was only changing the claim so as to claim a flange with a *rounded* corner, and he thereby was held to have *excluded a flange with an angular* corner, although one seems practically to have been the same thing as the other.

We believe that the instructions given at the request of the plaintiff, which are shown under our 38th and 39th assignments of error, are directly opposed to the law as laid down in the authorities which we have cited to the effect that the *patentee is bound by his claims*, and that if he strikes out part of what he originally claimed after his application is filed *and accepts his patent with those portions out* that he cannot afterwards go into court and assert that he may still *claim the very things thus stricken out by him* while in the patent office. Especially is the instruction given that is shown under our 39th assignment of error directly against the case just cited of *Railroad Co. vs. Mellon*. Indeed, if the Supreme Court was itself intending to overrule this decision it could hardly have chosen stronger language in which to do it than is contained in the instruction shown in said 39th assignment of error.

The last case cited, holds, as do many others that the scope of patents must be limited to the invention covered by the claim. That though the claim may be illustrated, it can never be enlarged by the language of the specification. (See page 118 of the decision ; also, *McLain vs. Ortmyer*, 141 U. S.; last two lines on page 423, and pages 424 and 425, and cases there cited.)

The instructions asked for by the defendant and covered by the tenth, eleventh, twelfth, thirteenth, fourteenth and fifteenth assignments of errors, were in accordance with the rules of law which the foregoing authorities sustain, and the refusal of the Court to give each of them, we respectfully submit was error.

We cite to sustain the instruction asked for and shown in the tenth assignment of error the following additional authorities :

*Rowell vs. Lindsay*, 113 U. S., latter part pages 101 and 102.  
Corn Planter Patent, 23 Wall., page 224.

The instructions asked for shown in our sixteenth and seventeenth assignments of error involve the same questions of law that were

involved in our motion for an instruction to the jury to find for the defendant and the same authorities which we cited upon that point apply to these. We think that it was error in refusing each of the last two instructions shown in said assignments of error, sixteen and seventeen.

The instructions as asked for by defendant and shown under assignments of error numbers eighteen to twenty-five inclusive, refer to the Button drier as an anticipation. The Button drier was a very successful drier. The Button driers were made and sold by the witness Wightman, and there were more of them used in Sonoma County than of all other driers put together according to what the testimony shows. The testimony of Mr. Wightman—Record pages 47 to 51—describes the Button drier and its operation, and it seems to be the same as the plaintiff's, except that its catches do not extend to the top, but only operate with the lower trays. The description of the Button patent on the first half of page 44 of the Record could almost be substituted for the plaintiff's drier, and the first claim of the Button patent, on the same page 44 of the Record, would almost apply as the second claim of the plaintiff's patent. Even the plaintiff's expert, L. W. Seely, says that if the claim of the plaintiff's patent should be held to apply only to the lower set of catches in his patent that then he should think there was exactly the same combination in the Button as in the Cassidy patent. Record near bottom of page 97. Much of Mr. Seely's testimony shows the bearing of the Button patent on the case.

We claim that the second claim of the plaintiff's patent includes only the lower set of catches; that a use of the lower set of catches with the other elements of the combination would infringe the patent whether any more of the catches were used or not; and this for two reasons. First because that is in accordance with the language of the claim. Second when the lower set of catches are used with the other elements of the combination, there is a complete combination used that performs one complete operation in receiving and lifting the tray to the set of catches above, and that no other operations are performed by the combinations except to keep repeating this one step. That the additional catches are only a multiplication of catches for repeating this one operation, and that such multiplication of catches makes an aggregation and cannot constitute any part of a patentable combination.

An aggregation is not patentable. If more parts are included than operate together in creating a joint action between them, then the whole combination becomes an aggregation and not a patentable combination.

Robinson on Patents, Sections 155 and cases thereunder.

*Pickering vs. McCullough*, 104 U. S., pages 317 and 318.

If we are right in this contention the Court should have given

the instructions asked for by us which are shown in the 21st, 22nd, 23rd, 24th and 25th assignment of errors.

In the instruction that was given shown in our 35th assignment of error the Court gave a correct definition of what constituted a mechanical equivalent. In that instruction as well as in the further instructions shown in assignments of error numbers 36, 37, 38, 39 and 40, the Court instructs the jury in effect that if the defendant uses all the elements of the plaintiff's combination except that he substituted mechanical equivalents for the spring catches that it infringed the patent. To this line of instructions in a case of this kind we object upon the ground that this is one of the cases in which the law of mechanical equivalents does not apply. All that plaintiff did himself was to substitute equivalent devices in combinations of devices which he found in the Alden drier and which existed in several other patents long before the plaintiff entered the field of invention at all. His drier did not develop any new mode of operation at all. Upon this proposition of fact there is no conflict, the evidence being that of the plaintiff himself, corroborated by others. We believe the rule of law upon this subject of mechanical equivalents, when boiled down to an essence, to be just this, viz.: So far as an inventor develops any *new mode of operation* by his invention the doctrine of mechanical equivalents applies, and any subsequent constructor who uses mechanical equivalents or substitutes (which are the same things), for the particular devices which the original inventor has used in applying his invention to practical use is an infringer; but that in so far as a second patentee has only reproduced an old effect or reproduced the same operation which he already found and appropriated by the substitution of mechanical equivalents or substitutes, he is not entitled to invoke the doctrine at all. Usually a mechanical invention develops some new mode of operation to a greater or less extent. If it does not the invention is limited in its work to the repetition of what had been already done.

If there is nothing new accomplished in mechanical operation it is because the same thing has been done before. Now, if a mechanic comes along and sees a certain combination of devices doing a particular part of the work in a machine and conceives the idea that he can take out one of the devices in that combination and put another in its place that will do the same work, and he acts on this conception and changes the devices, what has he done except to take out one device and put in another to do the same work? Suppose the owner of the first machine had a patent upon the particular combination that the second man found there. Of course the second man had not invented that combination and had not discovered the action that would be obtained from it or that it would do the desired work. Such first inventor had developed and discovered all of these things. The second one—whom we will call an "improver," as that



is what they generally call themselves, and there are many of them—did not discover or produce any new effect that could not be produced by that combination. He only thought after he saw what it would do that one of the devices which he found there could be taken out and another put in its place and that the combination would still do the same work that it did before. By what rule, of right, or reason, could such improver claim that *he* had acquired a right to all other mechanical equivalents of the original device which he had removed. He only substituted *one* mechanical equivalent for the device removed. *This was the extent of his invention.* Why then should he be given the right to say that no one else should not remove from that original combination the same device which he had removed and substitute for it some other equivalent of it which he had not thought of, or if he had thought of it he did not patent it. The authorities are that he has no such right, that as he is but an improver he cannot suppress other improvers.

Look at the same question in another light. The inventor of the original combination had an undoubted right to all mechanical equivalents which might be substituted to do the same thing as did the devices used by him in that combination. Now, there can only be one valid patent for one invention. What would be a mechanical equivalent of the device used by the inventor of the combination would also be a mechanical equivalent of the device which the improver had substituted, because those two devices were mechanical equivalents of each other. As there could be but one patent that would cover the same invention, and as the inventor of the original combination would, by his patent, cover all mechanical equivalents of the several devices used by him whenever organized into that combination, the improver could not by his patent also cover them. One patent must stop where the other begins and the second patent cannot begin until the place is reached where the first one stops.

Possibly this illustration may show the reason for the rule which the Supreme Court has so many times repeated that the party, who merely substitutes equivalents for what he sees in use, cannot sustain his patent for the reason that it does not cover any patentable invention. At any rate we think we have shown both by authority and reason that in this case the plaintiff's patent could not cover mechanical equivalents. At least it should have been left to the jury in some form to say whether there was any new mode of operation developed by the plaintiff's patent and they should have been instructed that if there was not in that case the patent would not cover mechanical equivalents. As the instructions stand the jury were not allowed to say anything as to whether the invention was or was not of a primary character, but were in effect *instructed* to give the patent the same force as though it was for a primary pioneer invention.

Upon the question of damages the defendant complains of errors shown under nine of the assignments of errors, viz.: from assignment of error number twenty-six to number thirty-four, both inclusive.

There are various methods of proving damages in a patent suit. These are presented in Walker on Patents, from Section 555 to Section 571. Also, in Robinson on Patents, from Section 1049 to, and including, Section 1071.

In this case, the plaintiff attempted to establish damages by proving that he had an established license fee for his invention, and that he was entitled to recover such license fee as his damages in this case. The defendant denies that there was *any* evidence of any established license fee for the part of the invention that was covered by the second claim of the patent.

The law is, that, if the plaintiff can show that he has an established license fee for the use of his invention, such license fee may be the measure of damages in a suit at law. The defendant complains of the instructions that were given upon this branch of the case, and also to the refusal to give others that it asked for.

The plaintiff proved that he had given two agents the right to make and sell his driers in the Eastern States for one hundred dollars for each drier. That he divided the one hundred dollars with the agents, so that he received fifty dollars on each one of the driers. He could not tell how many driers were sold. It was a great many years ago. But he had received from one of the agents two or three hundred dollars and "may be a little more." Another agent undertook to sell the driers in Oregon on the same terms, but without any results to the plaintiff. (See Record, pages 16 and 17.) The last royalty received by the plaintiff was in 1885, six years before the trial. (Record, page 30.)

As far back as 1880, the plaintiff had advertised his drier and made great efforts to introduce it into general use in Sonoma County, which was the county in which he lived. After all his advertising and efforts, there were only four of his driers built in all those years in Sonoma County, and three of those the plaintiff himself owned in whole or in part. Only one was made and used exclusively by any third party. (Record, pages 98 and 99.)

On page 99, the plaintiff testifies that the royalties he received in the East were for "fruit trays." If this was so, they were not royalties under his patent at all, since no claim of his patent covers fruit trays. We will present the argument however in the most favorable light in which the other portions of the plaintiff's testimony places it for himself, and consider the facts as though the royalties were paid, for the driers that were made under his patent.

Under the law where a patentee owns several patents on one machine and grants licenses to make and sell machines that are covered by all of his patents, and an infringer afterwards makes and

sells machines which infringe a part of those patents but not the whole of them, the patentee cannot claim as the measure of his damages for infringement of a part of his patents the royalty which he received for the use of all of his patents.

The same is also the rule in cases in which the patent in suit has several claims and the patentee has an established royalty for the use of the entire patent and an infringer does not infringe the whole of the claims but only a portion of them. In such cases the plaintiff cannot apply as the measure of damages for the infringement of a portion of the claims of his patent the royalty which he receives for the use of all his patent.

Before a royalty can be accepted as a measure of damages for an infringement it must appear that it was an *established* royalty. An occasional sale is not enough. It is not enough that the patentee has offered to sell rights at a fixed rate, but it must also appear that others had purchased at that rate *until the rate had become uniform* and the sales had been frequent enough so that the price could fairly be said to have been agreed upon, between the patentee and the public as the value of the invention.

Again when a royalty has been paid for the use of the invention for a *great length of time* it will not be the measure of damages for an infringement which lasted for only a portion of the time.

Robinson on Patents, Sec. 1057 and cases there cited.

*Rude vs. Westcott*, 130 U. S., 152.

Walker on Patents, Sec. 557 and citations there made.

*Colgate vs. Western Electric Co.*, 28 Fed. Rep., 147.

*Vulcanite Paving Co. vs. American Art. S. P. Co.*, 36 Fed. Rep., 378.

*Adams vs. Bellaire Stamping Co.*, 28 Fed. Rep., 360.

Walker on Patents, Sec. 563, and citations there made,

*Black vs. Munson*, 2 B. and A., page 626.

*Proctor vs. Brill*, 4 Fed. Rep., 415.

*Wooster vs. Simonson*, 16 Fed. Rep., 680.

*Moffitt vs. Cavanaugh*, 27 Fed. Rep., 511.

The last instruction given, shown in our 41st assignment of error, was to the effect that if the jury found from the evidence that the plaintiff had established a fixed uniform royalty for the use of his invention by others and had collected the same from others *in several instances* that then such royalty was the proper measure of damages.

We claim that this instruction was faulty. It left it for the plaintiff himself to *fix* the royalty and laid down the law to be, that, if he had collected the same in *several instances* from other persons that that was enough. This is not in accordance with the law as laid down by the authorities before cited. According to the instruction it would make no difference that the established royalty

had been abandoned. It would make no difference that it had only been paid in a few instances. It would make no difference that it had never been established in California, but had only been collected in the East, which was another country three thousand miles away from where the defendant had used the invention. It would make no difference that the royalty paid in the East so many years before gave the right to use the invention for *more than eight years* while the defendant could not use it, from the time it commenced until the patent would expire, more than about *three years* and that it had not used it two years when the suit was tried; and it would make no difference that the royalty had *not* been "paid by such a number of persons as to indicate a general acquiescence in its reasonableness by those who have occasion to use the invention." *Rude vs. Wescott*, 130 U. S., page 165; and worse than all; it made no difference that the royalty had been fixed for the *entire patent* while the defendant confessedly had *only used one part of it*.

The jury brought in a verdict for thirteen hundred and fifty dollars, and judgment was entered accordingly. Record, page 7.

There was no proof of any injury to the defendants' business on account of the driers built and used by the defendants, nor was there any proof of any profits or savings made by the defendants. So that it must have been the instructions given on the subject of royalties that the jury based its verdict upon.

It is true that the plaintiff testified that the selling price of the driers that he had made or caused to be made was two hundred and fifty dollars, and that the cost of them was one hundred and twenty-five dollars. Record, page 13. But there was no evidence that if the defendant had not built the driers that it would have purchased them of plaintiff. Neither was there any evidence that the particular portion of the driers that the defendant used was the special feature that controlled the market for the drier, nor was there any evidence that the drier controlled the market for fruit driers. On the contrary the evidence was quite the other way. The jury had no right to base their verdict upon this part of the evidence, and evidently did not do so. Both parties, as well as the Court, evidently considered that no damages could be recovered except under the theory of an established license fee. No instructions were asked by either party or given by the Court that were based upon any other theory or rule of damages than that of an established royalty.

Neither will a royalty paid in one part of the country be a measure of damages for an infringement committed in another part of the country. Neither will a royalty paid at one time be a measure of damages for infringement committed after that royalty has been abandoned.

Walker on Patents, Sec. 558.

Applying these rules to the plaintiff's own testimony and con-

sidering every thing as proved to which he testified, and also construing his testimony as favorably towards himself as its language will permit, and it was evident that the instructions asked for by the defendant from and including the one shown under the twenty-sixth assignment or error to and including the one shown in the thirty-fourth assignment or errors ought to have been given, or certainly some of them.

It was conceded all the way through the trial that the defendant had not infringed the first claim of the patent. The plaintiff's testimony showed that he had received the royalties that he did receive for the *entire right* of making and selling the *entire machine including what was covered by both of the claims of the patent*. Not the least effort was made to prove that any price had ever been fixed by the plaintiff or paid by any one for the right to use what was covered by the second claim of the patent. Not a particle of testimony of that kind was offered in the case. With the admission that the defendant had not infringed one of the claims of the patent, and with no proof whatever of the value of the other claim which was alleged to have been infringed, and with no proof of any other form of damages resulting to the plaintiff from the infringement, we think that the thirty-second instruction asked for by us ought to have been given.

As there was no proof of any license fee ever having been paid to the plaintiff in California, and no proof of any license fee having been paid since 1885 in the east, and as the defendant had not built its driers until the year 1890—Record page 64—it could not be said that the license fee paid in the east more than five years previously could in law be applied as the measure of damages in California five years later. Evidently the eastern royalty had long been abandoned; probably because no one would pay it. None had been paid since 1885 and that constituted an abandonment of it, at least on the part of the public. These being established as undisputed facts the applying of the established facts to the law and deciding what the rights of the parties under them were was a question of law. We think that we were entitled to have the 27th instruction which we asked for given. Also the 29th.

As it was a conceded fact that the defendant had not infringed the first claim of the patent, and no proof was introduced showing any royalty paid for the use of the second claim we were entitled to have the Court give the instructions asked for as shown under the 28th, 30th and 33rd assignments of error.

The instructions shown in the 31st, 32nd assignments of error are but elementary and should have been given.

*Gerretson vs. Clark*, 111 U. S., 120.

*Dobson vs. Hartford Carpet Co.*, 114 U. S., 444 and 445.

*Blake vs. Robertson*, 94 U. S., 728.

*Black vs. Thorne*, 111 U. S., 122.

These instructions were almost in the very language of the Supreme Court as contained in the decisions last above cited, and they are in accordance with the rules of law on the question of damages as we have always understood them to be.

Our exceptions are specific. The entire charge of the Court is shown on pages 111 118 of the Record. To the general fairness of the charge we pay our tribute of respect. But notwithstanding this we believe that injustice has been done to our client in the particular matters covered by our exceptions. Whether we are right or wrong is the issue now submitted to this high tribunal for final determination.

Respectfully submitted,

M. A. WHEATON,

I. M. KALLOCH,

F. J. KIERCE,

*Counsel for Appellant.*

No. 39.

---

UNITED STATES CIRCUIT COURT OF APPEALS  
NINTH CIRCUIT.

---

October Term, 1891.

---

HUNT BROTHERS FRUIT PACKING COMPANY,  
*Plaintiff in Error,*

VS.

JOHN W. CASSIDY,  
*Defendant in Error.*

---

BRIEF FOR DEFENDANT IN ERROR.

---

JOHN H. MILLER,  
J. P. LANGHORNE,  
*Attorneys for Defendant in Error.*

---

FILED  
JUL 8 - 1892





IN THE  
United States Circuit Court of Appeals

FOR THE NINTH CIRCUIT.

---

HUNT BROS. FRUIT PACK-  
ING COMPANY,

*Plaintiff in Error,*

*vs.*

JOHN W. CASSIDY,

*Defendant in Error.*

---

No. 39.

---

ON WRIT OF ERROR.

Action at law by defendant in error against plaintiff in error to recover damages for infringement of a patent; trial by jury; verdict for defendant in error for \$1,350, and judgment accordingly. The case is brought here by writ of error.

The patent in suit was granted to John W. Cassidy on Jan. 25, 1876, is numbered 172,608, and covers "Improvements in drying apparatus," used for drying fruits, vegetables and other products. It contains two claims. Infringement is charged of the second one only.

The drier is a "stack drier," containing an

upright drying chamber provided with laterally disposed trays and a mechanism for moving them from the bottom to the top of the stack, each tray, filled with undried fruit, being inserted at the bottom and gradually moved upward to the top, where it is then removed. A furnace in the bottom of the stack underneath the trays furnishes ascending currents of heat.

The device covered by the first claim is a system of flues for evenly distributing the heat. No infringement thereof is charged and it may be dismissed from consideration.

The second claim covers a mechanism for moving the trays upward through the stack or drying chamber. It consists of four stationary posts, one at each corner of the drying chamber, vertically disposed, extending from the bottom to the top and provided at intervals with spring catches, which extend into the chamber at right angles, forming seats for the edges of the trays and adapted to recede for the trays to pass over them, combined with four movable posts adjacent to the stationary posts, provided with similar catches registering laterally with the catches on the stationary posts, and any suitable mechanism for moving them by a vertical reciprocating motion within the chamber. The operation is as follows: The two sets of posts being so disposed that their

respective catches will register in a horizontal plane, a tray of undried fruit is inserted laterally through a door at the bottom and caused to rest on the lowermost set of catches, the lifting mechanism is then set in motion by any suitable power, hand or otherwise, the movable posts are thereby moved upward a step until the top of the tray comes in contact with the second set of catches on the stationary posts, which are thereby depressed into a slot, the tray then moves over the depressed catches, which, when the tray passes, spring back into normal position and allow the tray to rest thereon. By a reverse movement of the lifting mechanism the movable posts are then caused to descend to their initial position, another tray is inserted and the former operation repeated until the first tray reaches the top and the stack is full. When sufficiently dried the trays of fruit are taken out one by one at the top through a side door.

The second claim reads as follows:

“In combination with a drier the stationary posts K, provided with spring catches  $n\ n$ , and the vertically moving posts L, provided with spring catches  $n^1\ n^1$ , and suitable mechanism for operating the posts L, substantially as and for the purpose set forth.”

The defendants have used a mechanism substantially similar, except that they have substituted

for the spring catches, catches which fall out by gravitation, referred to in the Record as "gravity catches."

The specification of the patent says:

"Catches which would fall out by gravitation might be substituted for the springs in some cases."  
(Record 11.)

The evidence shows that Cassidy made his invention in April, 1874, and in his first drier used gravity catches. Defendants, when on the witness stand, admitted that their gravity catches were the mechanical equivalents of Cassidy's spring catches, and their counsel concede it in their brief.

In preparing our brief we have been put to great disadvantage by reason of the peculiar tactics pursued by opposing counsel. Though the Record shows 41 assignments of error, yet their brief contains no assignment of the *errors relied on*, nor does it set out separately and particularly *the errors relied on and intended to be urged*, thereby directly violating Rule 24 of this Court.

On the contrary their brief is a confused mass of argument, without any order or system, and leaves to the ingenuity of the reader the task of fishing out from the Record the particular assignments of error relied on and then applying thereto the appropriate part of the argument. For the

purpose, however, of relieving the Court from this unusual and most unreasonable labor, we have endeavored to evolve some system and order out of counsel's chaotic brief, by bunching their numerous assignments of error. We hope thereby to put the matter into intelligent form.

As near as we can figure out the matter, the assignments of error found in the Record may be grouped as follows:

1. Alleged errors in the admission and rejection of testimony, represented by Assignments 1, 3, 4, 5, 6, 7, 8 and 9.

2. Alleged error in refusing to instruct the jury, at the close of plaintiff's case in chief, to render a verdict for defendant, represented by Assignment 2.

3. Alleged errors in refusing to give to the jury certain instructions requested by plaintiff in error concerning matters appearing in the file-wrapper of Cassidy's patent, represented by Assignments 10, 11, 12, 13, 14 and 15.

4. Alleged error in refusing to instruct the jury concerning the prior Alden drier, as requested by plaintiff in error, represented by Assignments 16 and 17.

5. Alleged error in refusing to instruct the

jury concerning the prior patent of Button, as requested by plaintiff in error, represented by Assignments 18, 19, 20, 21, 22, 23, 24 and 25.

6. Alleged error in instructing the jury on the subject of mechanical equivalents, represented by assignments 35, 36, 37, 38, 39 and 40.

7. Alleged error in instructing and refusing to instruct the jury on the question of damages, represented by assignments 26, 27, 28, 29, 30, 31, 32, 33, 34 and 41.

Before proceeding with our argument we desire to call attention to one fact which seems to have escaped the attention of counsel for plaintiff in error, or at any rate it is ignored by them. This case is brought here by writ of error, because it was an action at law. Consequently, the review by this Court can extend only to matters of law. All questions of fact, which were submitted to and passed upon by the jury, must be deemed to be conclusively determined, and are not reviewable in this Court.

Says Mr. Justice Nelson as early as 1846, in the case of *Zeller's Lessee vs. Eckert et al.* (4 How., 298):

“ We have no concern, on a writ of error, with questions of fact, or whether the finding of the jury accords with the weight of the evidence. The

law has provided another remedy for errors of this description, namely, a motion in the Court below for a new trial, on a case made.”

The learned Justice than proceeds to condemn in the most caustic terms the practice of incorporating the entire charge and evidence in a bill of exceptions, saying that it only served “to encumber and confuse the record, and to perplex and embarrass both court and counsel.”

This rule has been consistently followed by the Supreme Court ever since.

*Bank, etc. vs. Cooper* (137 U. S., 474).

*C. and N. W. R. R. Co. vs. Ohle* (117 Id., 123).

*Lancaster vs. Collins* (115 Id., 222).

*Express Co. vs. Ware* (20 Wall., 543).

*Packet Co. vs. McCue* (17 Id., 508).

*Gregg vs. Moss* (14 Id., 564).

*Barreda vs. Silsby* (21 Id., 146).

*Hyde vs. Stone* (20 Id., 170).

*York R. R. Co. vs. Meyers* (18 Id., 252).

*Arthurs vs. Hart* (17 Id., 14).

*U. S. vs. Morgan* (11 Id., 158).

*Phillips vs. Preston* (5 Id., 289).

*Johnson vs. Jones* (1 Black., 220).

*Parsons vs. Bedford* (3 Pet., 433).

Yet counsel for plaintiff in error have argued the case just as if it were an appeal in an equity

case, where all the *facts* are reviewable as well as the *law*, or as if the case were on final hearing before a *nisi prius* court. In other words, their contention practically is that the evidence is insufficient to support the verdict, and we are treated to page after page of dissertation in their brief on that theory. For instance, take from near the bottom of page 12 to below the middle of page 15, and we find an argument that Cassidy's patent was anticipated, or at least was void for lack of invention by reason of certain prior patents, which were offered in evidence. Now anticipation and want of invention are simple *questions of fact* to be passed on by a jury, and when so passed on, cannot be reviewed on a writ of error.

*Turrill vs. R. R. Co.* (1 Wall., 491)

*Tucker vs. Spaulding* (13 Id., 453).

*Bischoff vs. Wethered* (9 Id., 812).

The above is given as one of the glaring illustrations of counsel's line of argument, but the entire brief appears to be framed on the same theory. That such is not the law, and will not be tolerated by this Court is well settled by the rules of appellate practice, and no one ought to know it better than counsel for plaintiff in error.

Having premised this much for the purpose of eliminating from the case such irrelevant and unreviewable questions as are found argued in the



brief of opposing counsel, we now turn our attention specifically to the alleged errors, following the order indicated in the grouping hereinabove made, and taking up each group *seriatim*.

## I.

### ALLEGED ERRORS IN THE ADMISSION AND REJECTION OF EVIDENCE—REPRESENTED BY ASSIGNMENTS OF ERROR 1, 3, 4, 5, 6, 7, 8 and 9.

The first one of these is too trivial to dwell on at length. Mr. Cassidy was asked what, in his judgment, would be the comparative cost between his drier and the Alden. This question was objected to and the objection was overruled. In this there was no error. The witness was a mechanic by trade and had had long experience in building fruit-driers. He knew exactly what the cost of his own drier was; but not having built any Alden driers, he did not know their *exact cost* of his own knowledge. However, he was perfectly familiar with them, had seen them constructed and operated for years, and was an expert mechanic and practical builder of fruit-driers. Under such state of facts it was competent for him to compare the cost of the two driers, and there was no error in allowing him to do so.

But were there any force in the objection it could not be considered here because not properly

framed in the Court below. The objection interposed in the Court below was as follows:

“ Mr. Wheaton—I object because the witness says he does not know what the Alden drier would cost.”

The question asked was not what the Alden drier would actually cost, but which, in the witness' judgment, would be the cheaper to construct, his drier or the Alden. (Record 20.) The witness was only asked for his *opinion*, his best *judgment*, not for the *exact fact*. The objection interposed was not that such opinion was incompetent, but was based on the contention that the witness did not know the *exact fact*, a thing which was not asked him and was not included in the question. If counsel had objected on the ground that the witness' *opinion* or *judgment* on the matter was incompetent, that would have been the same objection which they now urge in this Court. They interposed no such objection in the Court below. Consequently it cannot be considered here.

In regard to the remaining assignments of error under this grouping, being 3, 4, 5, 6, 7, 8 and 9, counsel say in their brief: “ While we do not intend to waive any of the exceptions between the second and tenth, we will not stop to make an argument upon them.” (Brief 12.)

Under well settled rules of appellate practice this amounts to a waiver of said exceptions. If a party alleging error does not specifically point it out, certainly he cannot expect the Court to perform that service for him. We take it, therefore, that these particular exceptions will not be considered at all, and consequently, we pass them by.

“Where no argument has been submitted for the plaintiff in error, the Court infers that the exceptions have been abandoned.”

*Duwall vs. United States* (18 U. S. Law Ed., 252).

## II.

ALLEGED ERROR OF THE COURT IN REFUSING TO INSTRUCT THE JURY, AT THE CLOSE OF PLAINTIFF'S CASE IN CHIEF AND BEFORE DEFENDANT HAD INTRODUCED ANY EVIDENCE, TO RENDER A VERDICT IN FAVOR OF DEFENDANT.  
ASSIGNMENT OF ERROR No. 2.

At page 30 of Record it appears that after the plaintiff had closed his case in chief, and before any evidence was offered by defendants, and without resting their case, counsel for defendant made this request of the Court:

“Mr. Wheaton—We will ask your Honor for an instruction that the jury should bring in a verdict for the defendant, on the ground that the

plaintiff's own testimony shows that the change that he made consisted of substituting these posts and spring catches—or other catches, I will not make a point on the word spring, for the chains and lugs in the same kind of a drier.”

This motion was denied and exception was taken. Thereupon the defendant proceeded to and did introduce a large mass of testimony in defense of the action. The plaintiff then introduced evidence in rebuttal and rested. *No motion was then made for an instruction to the jury to bring in a verdict for defendant*, but the entire case was argued on its merits by both counsel for plaintiff and defendant, and after the charge by the Court, was submitted to the jury in the usual manner, who promptly rendered a verdict in favor of the plaintiff.

Under these circumstances the alleged error, if any there be, in the Court's refusal to give the instruction asked for, is waived.

It is a settled rule that such a motion cannot be made by a defendant as of right, *unless at the close of the whole evidence in the case*; and that, if the defendant, at the close of the plaintiff's evidence, and without resting his own case, requests and is refused such ruling, the refusal cannot be assigned as error in the Appellate Court.

In *Accident Insurance Co. vs. Crandall* (120 U. S., 530), a precisely similar state of facts arose:

“ At the close of the plaintiff’s evidence, the defendant moved the Court to instruct the jury that, under the law and the evidence in the case, the plaintiff was not entitled to recover. The Court overruled the motion, and the defendant excepted. The defendant then introduced evidence, and the case was argued to the jury.” (Page 529.)

Upon this state of facts, Mr. Justice Gray said:

“ The refusal of the Court to instruct the jury, at the close of the plaintiff’s evidence, that she was not entitled to recover, cannot be assigned for error, because the defendant, at the time of requesting such an instruction, had not rested its case, but afterwards went on and introduced evidence in its own behalf.”

On a similar state of facts a similar ruling was made in *Northern Pacific R. R. Co. vs. Mares* (123 U. S., 713), Mr. Justice Mathews, delivering the opinion of the Court and affirming *Accident Insurance Co. vs. Crandall*. The ruling was adhered to and the doctrine re-affirmed in *Robertson vs. Perkins* (129 U. S., 236), where Mr. Justice Blatchford said:

“ The motion was denied by the Court, and the defendant excepted. But, as the defendant did not then rest his case, but afterwards proceeded to introduce evidence, the exception fails. *Accident Ins. Co. vs. Crandall*, 120 U. S., 527.”

The latest ruling on the point is found in *Columbia and P. S. R. Co. vs. Hawthorne* (12 Sup. Ct. Rep., 592), decided on April 4, 1892, where Mr. Justice Gray said:

“ The question of the sufficiency of the evidence for the plaintiff to support his action cannot be considered by this Court. It has repeatedly been decided that a request for a ruling that upon the evidence introduced the plaintiff is not entitled to recover cannot be made by the defendant as a matter of right, unless at the close of the whole evidence, and that, if the defendant at the close of the plaintiff's evidence, and without resting his own case, requests and is refused such a ruling, the refusal cannot be assigned for error.”

The facts of our case brings us squarely within the rule of the above citations. At the close of plaintiff's case, the defendant, without resting its own case, requested the ruling, which was denied. Thereafter the defendant introduced evidence and argued the case to the jury, without any further request that the Court should instruct the jury to render a verdict in its favor. We say, therefore, the exception is waived and cannot be assigned as error in the Appellate Court.

No one of the cases cited by counsel for plaintiff in error is contrary to these views. In the first one, *Randall vs. Baltimore and Ohio R. R.* (109 U. S., 480), the Court says:

“ *At the close of the whole evidence* the Court directed the jury to return a verdict for the defendant, because the evidence was such that if a verdict should be returned for the plaintiff, the Court would be compelled to set it aside.”

In the second one, *Heald vs. Rice* (104 U. S., 737), it is said:

“ The Court was asked at the close of the plaintiff’s testimony, *and again when all the evidence on both sides had been introduced*, to instruct the jury to return a verdict for the defendant.”

In the third one, *Fond du Lac County vs. May* (137 U. S., 395), the Court says:

“ No evidence in rebuttal was offered by the plaintiff, and *the testimony being closed, the defendant renewed its motion for a verdict to be directed for it*, on the grounds before stated; but the motion was denied and the defendant excepted.”

In the fourth one, *May vs. Juneau County* (137 U. S., 408), the Court says:

“ *At the close of the testimony on both sides*, the defendant moved the Court to direct a verdict for the defendant, etc., etc. The Court granted the motion and directed the jury to return a verdict for the defendant, which was done.”

In all of these cases the motion was made *at the close of the whole evidence*, and that was the proper time. In the case at bar counsel for plaintiff in error made their motion *at the close of plaintiff’s case in chief*, without resting their own case and

before introducing any evidence in defense. The motion was denied, and thereupon the defendant introduced its evidence in defense, the plaintiff introduced evidence in rebuttal, and the case was then argued and submitted to the jury. The defendant did not, *at the close of all the evidence, renew its motion.* On the contrary, its counsel seemed to acquiesce in our contention that they were not entitled to the instruction, because they propounded and requested instructions, in which the question of fact involved in its motion was left to the jury. By that course they plainly receded from the position which they had before taken and which they now take in their brief. If they had desired to save the point in this Court, they should have rested their case at the time they requested the instruction, or should have renewed the request at the close of the entire testimony when they did finally rest their case. They did neither. They tried to get the ruling in the first instance as a matter of law when the case was but half tried, and failed. They then tried another tack, by introducing evidence and asking the Court to instruct the jury that the patent would be void, if they found *as a matter of fact* that the Alden was an anticipation. In this, too, they failed, but in pursuing this course they waived their exception to the Court's first ruling. The Court found



against them as a question of law, and the jury found against them as a question of fact.

This *question of fact* having been submitted to the jury, the defendant cannot now complain of the verdict thereon. In actions at law this Court cannot review the facts passed on by the jury, but only questions of law; and where a litigant submits a disputed question of fact to a jury, he is bound by the verdict rendered thereon, unless the Court grants him a new trial, and cannot in the Appellate Court claim that it is a question of law, and, as such, reviewable. All contested questions of fact submitted to a jury are conclusively settled by the verdict. They are not reviewable in the Appellate Court.

*Lancaster vs. Collins* (115 U. S., 222).

*Bank, etc., vs. Cooper* (137 Id., 474).

We submit that no such legal jugglery as is now being attempted by counsel for plaintiff in error will be allowed. They will not be allowed to play fast and loose at the same time.

These considerations dispose of the major part of counsel's brief. All that portion of it from the middle of page 2 to the middle of page 12 is devoted to the above mentioned assignment of error No. 2, and may therefore be dismissed from further consideration, inasmuch as said assignment of error is not available in this Court.

*But even if said assignment of error were open for consideration here, still there would be no merit in the contention.*

There is no resemblance whatever between the Alden and Cassidy machines, further than the fact that they are both stack driers. But the Cassidy claim is not for a stack drier. It is for a peculiar mechanism to lift the trays in a stack drier. That mechanism is of an entirely different construction from Alden's. It operates on a different principle and in a different manner. In Alden's there are four endless chains, one in each corner of the stack, running over sprocket wheels and all geared together by a complicated mechanism, not shown by the evidence, to make them run synchronously. They have lugs attached at appropriate intervals, which project forward at right angles to form seats for the fruit trays: The chains have an upward continuous motion, always in one direction. Being flexible they are liable to buckle or twist when striking an obstruction. If they break, the entire column or stack of trays falls in a heap to the ground.

In the Cassidy device the movable posts have a vertical reciprocating, not a continuous motion. They move upward a step and then move downward a step. They have a step-by-step movement which is entirely different from the Alden con-

tinuous movement. The posts are rigid, not flexible, and hence they are not liable to buckle or twist. They are enclosed in slots or grooves and are not liable to meet obstructions and become broken. They are cheaper than the chains and lugs. In every way they are more effective.

As proof of this the evidence shows that Cassidy's invention immediately went into use and the public generally began copying it. "It had a tendency of rather revolutionizing the fruit-drying business, for immediately after I got my patent most everyone was using these devices East. They were using my catches and sliding posts," says Cassidy. (Record 19.) Whereas the Alden drier, which had previously been generally known and used, went out of use on the Pacific Coast about the year 1875 and has not been there used since although the patent has expired. (Record 20.)

Further, Cassidy testifies positively that the lifting mechanisms of the two driers are of different construction; that they operate in different ways: *that they are NOT mechanical equivalents* (Record, pp. 24-5.) In view of these facts and this testimony, all of which is admitted to be true by the motion, it seems puerile to contend that the Court should have held as matter of law the two driers to be the same, and instructed the jury to render a verdict for the defendant on that ground.

Counsel's precise contention is that all Cassidy did was to substitute sliding posts and catches for the Alden chains and lugs. That might be admitted, and still his conclusion would not follow, because the sliding posts and catches are not mechanical equivalents of the chains and lugs. Cassidy so testifies, which testimony must be taken as true, and the construction and operation of the two devices confirm this testimony. In their argument counsel have lost sight of these facts.

And right here it may not be out of place to enquire, when a trial Court is justified in giving such an instruction.

In *Royer vs. Schultz Belting Co.* (135 U. S., 325), the infringing machine was of a different construction from the patented machine, though working on the same general plan and accomplishing the same result. At the close of plaintiff's testimony the defendant demurred to the evidence. The Court sustained the demurrer and directed the jury to find for defendant. (28 Fed. Rep., 850.) In reversing the judgment the Supreme Court said:

“ We think the Circuit Court erred in not submitting to the jury the question of infringement under proper instructions. \* \* \* It was not a matter of mere judicial knowledge that the mechanical differences between the two machines were material, in view of the character of the patented

invention and of the claims of the patent; and we are unable to concur with the view of the Circuit Court, in its opinion denying the motion for a new trial (29 Fed. Rep., 281), that this is a case where, if the jury had found a verdict for the plaintiff, on the evidence put in by him on the question of infringement, all of which evidence the bill of exceptions states is set forth therein, it would have been proper for the Court to set aside such verdict. *Keyes vs. Grant*, 118 U. S., 25."

In the case of *Keyes vs. Grant* cited *supra*, a certain prior publication was put in evidence as an anticipation. Upon comparison of the two the Court was of the opinion that they were so nearly identical as to negative any invention on the part of the patentee, and instructed the jury to find for the defendant. The Supreme Court reversed this ruling, saying *inter alia*:

"Clearly it was not matter of law that the specification of the plaintiff's patent and the publication of Karsten, taken in connection with the drawings intended in illustration, described the same thing. The differences were obvious in the arrangement of the parts and the relation of the basin in one and the fore-hearth in the other to the interior of the furnace, and the mode of connecting the one with the other for the purpose of drawing the metal from the furnace. So that it was not a matter of mere judicial knowledge that these differences were either not material in any degree to the result, or, if material at all, were only such as would not require the exercise of the

faculty of invention, but would be suggested by the skill of an experienced workman employed to produce the best result in the application of the well known arrangements of the furnace.”

These cases would seem to dispose of counsel's theory. Undoubtedly the Alden and Cassidy devices were of different construction. This difference was striking and radical. The chains and lugs of one had no mechanical similarity whatever to the sliding posts and catches of the other. Moreover, their modes of operation were different, one having a continuous motion in one direction, and the other a vertical reciprocating motion. They accomplished the same result, so far as lifting the trays in a stack drier, but did it in a radically different way and by a radically different mechanism. Besides, both Cassidy and the expert testified that they were not mechanical equivalents. Therefore we say in the language of the Supreme Court—*it was not a matter of mere judicial knowledge that these differences were either not material in any degree to the result, or, if material at all, were only such as would not require the exercise of the faculty of invention, but would be suggested by the skill of an experienced workman employed to produce the best result in the application of the well known arrangements of the furnace (drier).*

This language could not be apter if it had been

framed specially with a view to the case now before the Court.

But further, if we view the question as one of law, though it was undoubtedly a question of fact, the ruling of the lower Court was correct. The combination of elements in Cassidy's second claim calls for, (1) a drier; (2) four stationary posts; (3) catches thereon; (4) movable posts having a vertical reciprocating motion; (5) similar catches thereon, and (6) mechanism for operating the movable posts.

Unless the equivalents of *all these elements* were found in the Alden drier, counsel's contention fails. Now the Alden drier did not have *four stationary posts provided with catches, nor any pretense thereof, nor any equivalent thereof*. That element was entirely wanting. Nor did it have the *movable posts carrying similar catches and having the vertical, reciprocating motion*. It had a flexible chain carrying lugs, operating always with a continuous motion in one direction. These were not mechanical equivalents of Cassidy's sliding posts and spring catches. At no stage in the Alden operation was a tray caused to depress a catch, pass over it, and then rest on the next catch above. The tray rested on the single set of lugs during its entire progress from top to bottom. The two operations were entirely different in *the*

*manner of performance.* The one was the continuous circular motion of a wagon wheel, the other the reciprocating rectilinear motion of an engine piston-rod. Hence, they were not equivalents, and the premises of counsel, on which he bases his conclusion of law, have no foundation in fact. He always assumes that the two devices are equivalents, merely because they attain the same end, and loses sight of the fact that they attain that end *in a different manner and by a different mechanism.*

We submit that the Alden drier does not affect the Cassidy patent in any light it may be viewed, whether as a question of law or one of fact. Indeed counsel for plaintiff in error thought so little of it that they did not even set up the Alden as an anticipating device in their pleadings, although they did set up a large number of other driers as such, nor did they even produce in evidence the Alden patent itself. They merely took oral testimony of its construction. If they have any confidence in the position they now take, it is a little singular that such omissions should have occurred. It appears to us that the contention is a mere afterthought, a mere make-shift for the want of better arguments, an effort to confuse and befog the Court with a piece of complicated mechanism of which there is no sufficient or proper evidence in



the Record. We are constrained to think that the contention is not made in good faith, because the long experience of counsel ought to teach them better.

### III.

ALLEGED ERROR OF THE COURT IN REFUSING TO GIVE CERTAIN INSTRUCTIONS REQUESTED BY PLAINTIFF IN ERROR CONCERNING CERTAIN MATTERS APPEARING IN THE FILE-WRAPPER OF CASSIDY'S PATENT. ASSIGNMENTS OF ERROR 10, 11, 12, 13, 14, 15.

So far as the 10th and 15th assignments are concerned, they are not good, for the reason that the Court gave in its own language to the jury substantially the instructions requested. On page 112 of the Record, from line 13 to line 30, we find that these points are fully covered by the Judge's charge to the jury. Hence there was no necessity to repeat the matter, and refusal to do so was not error.

In regard to the 11th assignment above referred to, the most casual reading shows it to be immaterial.

The 12th, 13th and 14th are not good, because the instructions there refused were purely matters of law for the Court, and not for the jury. The construction of a patent is always a matter of law

for the Court. It is the province of the Court to determine its proper construction, and then to give such construction to the jury. In this case, for instance, it was the duty of the Court to first determine as *matter of law* whether the patent covered gravity catches as well as spring catches. This the Court did do and instructed the jury accordingly. But the instructions embodied in the 12th, 13th and 14th assignments undertook to cast upon the jury the determination of that question of law. In other words, it was calling upon the jury to construe the patent. Consequently it was proper to refuse them, and it would have been error to give them, because the matter was solely a question of law for the Court.

#### IV.

ALLEGED ERROR IN REFUSING TO INSTRUCT THE JURY CONCERNING THE PRIOR ALDEN DRIER, AS REQUESTED BY PLAINTIFF IN ERROR. ASSIGNMENTS OF ERROR 16 AND 17.

The substance of the instructions embodied in these assignments of error had already been given to the jury by the Court in its general charge, and hence, it was not error to refuse them. From the bottom of page 112 to the top of page 115 of the Record will be found a full, fair and most careful charge to the jury concerning the Alden drier.

It leaves absolutely nothing to be said on the subject. It contains the substance of all that was proper in the 16th and 17th assignments, besides a great deal more.

But there is another reason why the 17th assignment is bad and it is this: The instruction requested assumed *as a fact* that the lifting device of the Cassidy patent was a mechanical equivalent of the Alden. But that was the very point in issue, and it was a question of fact to be decided by the jury. Hence it would have been a palpable error to give such instruction.

## V.

ALLEGED ERROR OF THE COURT IN REFUSING TO INSTRUCT THE JURY CONCERNING THE PRIOR PATENT OF BUTTON, AS REQUESTED BY PLAINTIFF IN ERROR. ASSIGNMENTS OF ERROR 18, 19, 20, 21, 22, 23, 24 AND 25.

The 18th assignment is clearly frivolous in so far as it tells the jury that a patent was granted to Button on September 22, 1874, because the patent was in evidence and the jury knew that fact. In so far as the instruction undertakes to tell the jury that the Button patent was applied for on July 20, 1874, it is clearly erroneous, because:

1. Whatever effect the Button patent has as an

anticipating patent, must date from its issuance, not from its application; and

2. There was no competent evidence in the case showing the date of the application.

It is well settled that when a prior patent is set up as an anticipation, the date of the *issuance* of the patent is the material point to determine, and the date of the application is utterly immaterial, irrelevant and incompetent. This results from the provisions of the statutes (R. S., § 4886), which provide that patents may be issued for inventions which had not been before *patented*, etc., and (R. S., § 4920), that a patent sued on will be declared void, if the defendant show that the invention had been *patented* before by others. In other words, patents can be anticipated by prior *patents*, not by prior *applications*.

See 1 Robinson on Patents, § 332, and cases cited.

Nor was there any competent evidence showing the date of Button's application, even if that application could cut any figure in the case. The only evidence of the date of that application is the memorandum appearing in the space under the title on the specification. But that is not competent evidence of the fact.

*Walker on Patents*, § 129.

*Brush vs. Julien Co.* (41 Fed. Rep., 688).

*The 19th and 20th assignments are not good*, because the instructions therein requested are not true as matter of fact. Those instructions are both based on the assumption that the Button patent has "catches without springs." But, as matter of fact, such assumption is false. The Button patent has no such catches, but has spring catches. Hence the instructions were properly refused.

*The 20th assignment is not good* for another reason. It undertakes to say, that, if the Button catches were used "prior to the time that the plaintiff *applied for his patent*," then no invention is shown in Cassidy's patent. It should have been prior to Cassidy's *invention*, not prior to his *application for the patent*. A patent in suit can be anticipated or limited only by things which existed prior to the date of the *actual invention*. The date of application for the patent is immaterial.

*Klein vs. Russell* (19 Wall., 433).

*The 21st assignment of error is not good*, because the instruction therein requested was merely an abstract question of law not involved in the case. As a question of law it may be correct, but no such question was involved in the case. The defendant in error had not advanced

any proposition opposed thereto, and hence there was no necessity for any such instruction. To have given it would merely have tended to confuse the jury. Said the Court in *Haines vs. McLaughlin* (135 U. S., 598):

“It is not error to refuse to instruct as to an abstract question, and instructions should never be given upon hypothetical statements of fact of which there is no evidence.”

And such is the universal rule on the subject.  
See

*Dwyer vs. Dunbar* (5 Wall., 329).

*Hamilton vs. Russell* (1 Cr., 318).

*Bryan vs. United States* (1 Black., 149).

*McNeil vs. Holbrook* (12 Pet., 84).

*Rhett vs. Poe* (2 How., 483).

*Beaver vs. Taylor* (1 Wall., 637).

*Chicago vs. Robbins* (2 Black., 429).

*N. Y., etc., Co. vs. Fraser* (130 U. S. 611).

*The 22d assignment of error is bad, because—*  
(1.) It undertakes practically to tell the jury that the Button patent is a full anticipation of the second claim of Cassidy’s patent, (2) Cassidy’s invention was made prior to the issuance of Button’s patent, and in no event, therefore, could Button be an anticipation, and (3) Whatever there was in the instruction proper to give had

already been given by the Court in its general charge to the jury.

The instruction asked undertakes to give a description of the Button mechanism as set forth in his patent, and then tells the jury that, if they find such description in the Button patent, they should conclude that the Button patent is a *full anticipation*, etc. This is nothing more than a cunning and artful way of telling the jury that the Button patent was a *full anticipation*. It is a piece of legal legerdemain not to be tolerated. It was a question of fact solely for the jury to decide what the Button patent did describe, and whether or not such description amounted to an anticipation. It is true the instruction does not *in terms* undertake to say what is the description of the Button patent, but it does say, if a given construction (which will be found to be the exact description of the Button patent) is shown in said Button patent, then there is a full anticipation. This amounts to telling the jury that the Button patent is a full anticipation, and if the instruction had been given, the jury would have been compelled to find an anticipation, and thereby the decision on a pure question of fact would have been taken from them. The instruction was an attempt to do indirectly what it was not proper to do directly.

(2.) But further, Cassidy's invention was actually made prior to the date of Button's patent, and in no event, therefore, could the Button patent be an anticipation, even if it showed the identical thing claimed by Cassidy. The Button patent is dated September 22, 1874, (Record 43). The date of Cassidy's invention is April, 1874, (Record pp. 82-3). We introduced a drawing to prove that fact made in April, 1874, and Cassidy testifies that he made the invention at that time and actually built a drier embodying it.

When a patent in suit is sought to be anticipated by a patent prior in date, the plaintiff is allowed by way of rebuttal to prove that his invention was actually made before the date of the anticipating patent, and by such rebuttal evidence he destroys the force of the alleged anticipating patent.

*St. Paul Plow Works vs. Starling* (140 U. S., 198).

*Clark Thread Co. vs. Willimantic Linen Co.* (140 U. S., 492).

*Loom Co. vs. Higgins* (105 U. S., 592).

*Elizabeth vs. Pavement Co.* (97 U. S., 126).

*Tyler vs. Crane* (7 Fed. Rep., 775).

(3.) But finally, whatever there was in the instruction proper to give had already been given by the Court in its general charge. See charge of the Court at page 115 of Record from line 15



to line 39. All that was proper to say about the Button patent was there said, and it was sufficient to enable the jury to pass on the question of the anticipating force of the Button patent.

*The 23d and 24th assignments of error are bad because—*

1. They embrace abstract questions of law which were not in the case, and,

2. The counsel for plaintiff in error waived them.

These two instructions are aimed at the question of *aggregation*, the contention being that there was no joint action between the lower set of catches in Cassidy's patent and the set immediatly above, and that, therefore, the second claim was void as being a mere aggregation if it included both sets of catches.

In answer to this it may be said that no such question was involved in the case. We did not contend for such construction of the claim, because it was not necessary for our case. Nor did the Court give any such construction of the claim. Consequently, the instructions embodied merely abstract questions of law not pertinent to the case, not applicable to or explanatory of any facts in the case, and were very properly refused.

It is not error to refuse to give an instruction on

an abstract question of law not involved in the case.

But whatever merit there was in the instructions asked, was waived at the trial. At pages 115-16 of Record we find the following in the Judge's charge:

“A combination of mechanical elements, in order to be patentable, must produce a different force, or effect, or result in combined forces or processes that are different from those given by their separate parts. [N. B. This is a clear definition of aggregation in the words of the Supreme Court.—J. H. M.] There has been some discussion here as to whether or not this was a patentable combination or an aggregation. No instructions have been asked by counsel on either side, and I suppose none are requested upon that point. Unless counsel desire it, I shall not submit that question to the jury. If they do desire it, I shall give the jury instructions as to the distinction between a patentable combination and an aggregation.

Mr. Wheaton—I did not have time. All I meant by that, was, if these upper set of catches were to be read into the claim, that that would be an aggregation, as the expert testified that they acted independently of each other. As to the other part of it, I do not think it will apply.

The Court—I shall not give any instruction about that.”

We submit that this amounts to a waiver of the two instructions under consideration. They relate solely to aggregation. The Court asked counsel

if he insisted on having an instruction on the point. It appears that he did not so insist, and thereupon the Court stated that no instruction on the subject would be given. Counsel cannot now insist that there was error.

*The 25th assignment of error is bad.* It is ambiguous and confusing. It is not apparent whether it refers to the *invention* made by Cassidy or to an *actual drier* made by him. Besides, it refers to the *application* for the Button patent, whereas it should have referred to the *issuance*, because we have already shown that a prior patent can avail as an anticipation only from the date of its *issuance* and not from the date of *application*, and we have also shown that there is no competent evidence in the case showing the date of Button's application.

And finally, even if it be true that Cassidy's spring catches were not made until after Button's application, that would not affect the case, because the Button patent is not an anticipation of Cassidy's second claim. The Court submitted that question of fact to the jury and they found against such alleged anticipation. Counsel cannot now urge that here was an anticipation. That question of fact is settled and is not reviewable.

## VI.

ALLEGED ERRORS OF THE COURT IN INSTRUCTING JURY AS IT DID CONCERNING MECHANICAL EQUIVALENTS. ASSIGNMENTS OF ERROR 35, 36, 37, 38, 39 and 40.

The instruction objected to by the 35th assignment of error reads as follows:

“ If you find that the defendants have used all of these elements or their mechanical equivalents, combined together and accomplishing substantially the same result in the same way, then they have infringed this claim, that is, of course, if you find that there has been an invention. If there has been no invention you do not reach that question.

“ When, in mechanics, one device does a particular thing or accomplishes a particular result, every other device known or used in mechanics which skillful and experienced workmen know will produce the same result, or do the same particular thing, is a known mechanical substitute for the first device. It is sufficient to constitute known mechanical substitutes, that when a skillful mechanic sees one device doing one particular thing that he knows the other devices, with whose use he is acquainted, will do the same thing.”

In regard to the first portion of this instruction we shall consider the matter later on.

The latter portion is clearly correct. It is the identical language used by Judge Sawyer, in defining mechanical equivalents, in the case of *Carter vs. Baker* (1 Sawy., 512), the language being copied

*bodily from that decision.* That definition of Judge Sawyer has never been questioned, but has been repeatedly affirmed and re-affirmed by nearly all the Circuit Courts of the land. In fact the case of *Carter vs. Baker* is considered to be one of the celebrated cases in the annals of patent law, solely on account of this definition of mechanical equivalents.

*The 36th assignment of error is clearly bad.* The instruction there attacked correctly states the law governing the subject under discussion. It reads as follows:

“If you find that the gravity catches of defendant do the same thing in substantially the same way as the spring catches of plaintiff, and that a skilled mechanic, upon seeing the spring catches work, would know that gravity catches would do the same thing in the same way, then the two are mechanical equivalents.”

It would take more ingenuity than we possess to pick a flaw in this instruction. The only difference between the patented and infringing machines was in the catches. One had spring catches, the other gravity catches. If these two kinds of catches were mechanical equivalents there was an infringement. Otherwise not. Hence it was proper for the Court to give the jury the rule of law by which that question was to be determined. The rule announced was correct, and, therefore, the instruction was proper.

*As to the 37th assignment of error.* The instruction there given reads as follows:

“When a patent is not for a mere form, the patentee is not required to claim his invention in all the forms in which it may be embodied. All that he is required to do is to describe and claim it in the best form he has contemplated using it, and having done that, he will be protected in all forms by virtue of the doctrine of mechanical equivalents.”

This is in accordance with the law. Section 4888 of the Revised Statutes provides that the applicant for a patent, in case of a machine, “shall explain the principle thereof and the best mode in which he has contemplated applying that principle, so as to distinguish it from other inventions.”

After he has done that, he will be protected, however the form of his invention may be varied by others. He is not required to describe or claim *all the forms* in which his invention may be embodied, but only *one form*, viz: “The best form in which he has contemplated using it.”

The principle is as old as the hills that in patent law formal changes are nothing, mere mechanical changes are nothing.

In *Murphy vs. Eastman* (5 Fish., 306), the patentee had claimed a certain device in an *angular* form. The infringer had used it in a *circular* form. Said Judge Shepley:

“The patentee does not claim in terms the thing patented, however its form and proportions may be varied. But the law so interprets his claim without the addition of those words. In contemplation of law, after he has fully described his invention and shown its principle and claimed it *in a form which perfectly embodies it*, unless he disclaims other forms, *he is deemed to claim every form in which his invention may be copied.*”

In *LeRoy vs. Tatham* (2 Blatch., 486), Judge Blatchford said:

“A change of form is not a substantial change. A patentee is not confined to the precise arrangement shown in his patent. Formal changes are nothing; mere mechanical changes are nothing. All these may be made outside the description of the patent.”

In *Reed vs. Smith* (40 Fed. Rep., 886) and in *Ives vs. Hamilton* (92 U. S., 426) it was held that a true curve was the equivalent of a series of straight lines meeting one another at an angle.

In *Winans vs. Denmead* (15 How., 122) it was held that a car-body made in the form of a frustum of a cone was the equivalent of one made in an octagonal shape.

In *Manufacturing Co. vs. Bushing Co.* (31 Fed. Rep., 76) and also in *The Accumulator Case* (38 Fed. Rep., 143), it was held that a square hole was the equivalent of a round one.

In *Brush vs. Condit* (132 U. S., 39) it was held

than an annular or round clamp was the equivalent of a square or rectangular clamp.

And in the English case of *In re Newell* (4 C. B., 269) a cylinder with a spherical shaped top was held the equivalent of a cone.

*The 38th assignment of error is bad* for the same reasons given concerning the 37th. The instruction therein referred to is of the same general character as that referred to in the 37th. The same argument applies to both.

*The 39th assignment of error is also bad.* Counsel for plaintiff in error has indulged in an extensive argument on the subject-matter of this instruction, which reads as follows:

“The fact that in his original application plaintiff claimed as an element of his second claim *spring or other catches*, and that he afterwards struck out the words *or other*, leaving the element simply *spring catches*, does not limit his claim to spring catches nor deprive him of gravity catches, if the latter are mechanical equivalents of spring catches.”

In his original application to the Patent Office Cassidy asked for two claims, reading as follows:

“First. The flues C, passing around the drying chamber as shown, being enclosed at E, H, J, and having openings I, *m*, leading into the drying chamber from the cases, substantially as and for the purpose herein described.

Second. The device consisting of the stationary



posts K and the vertically moving posts L, provided with the spring or other catches *n n*, together with means for moving the posts L L for the purpose of elevating the trays substantially as herein described." (Record 34.)

In answer to this application the Patent Office replied:

"The claims are *not in the preferred form*. Fruit-driers being old, applicant's invention, if he has made any, must consist of some novel feature or combination of features, *in a fruit-drier*, and this, it is suggested, is what should be claimed.

For the first claim reference is made to *Dryers*, A. Mackey, 137,459, Apr. 1, 1873; Harrison & Savery, 156,849, Nov. 17, 1874; *Fruit-Dryers*, Mayhew, 94,967, Sept. 21, 1869; *Grain Dryers*, Eaton, 115,833, June 13, 1871.

"For 2d claim, see *Fruit Dryers*, M. P. Smith, 107,417, Sept. 13, 1870, re-issued; J. O. Button, 155,286, Sept. 22, 1874, and A. C. Lewis, 29,390, July 31, 1860. The application is rejected." (Record 34.)

In answer to this letter Cassidy filed an amendment in which he erased the old claims, and in lieu thereof inserted the following claims:

"1. In combination with the drying chamber the pipes or flues C, passing diagonally along the slotted openings I, around and outside of the dryer, and provided with coverings E, H, J, substantially as and for the purpose set forth."

"2. In combination with a drier the stationary posts K, provided with spring catches *n n*, and the

vertically moving posts L, provided with spring catches  $n^1 n^1$ , and suitable mechanism for operating the posts L, substantially as and for the purpose set forth." (Record 34-5).

These two claims were thereupon allowed by the Patent Office and are the present claims of the patent.

The argument advanced by counsel for plaintiff in error (see brief, pp. 15-18) is that the Patent Office specifically refused to allow the claim for "spring or other catches," and that Cassidy thereupon amended by striking out the words "or other," and asking for "spring" catches alone. This, they argue, was an abandonment of the "other" catches and a limitation of the claim to "spring" catches, without allowing the patentee the benefit of equivalents.

In reply to this we say the *Patent Office did not* refuse to allow the patentee the "other" catches. They simply said that the claims were not "in the preferred form." We note two reasons why they were not in the preferred form. First, the claims were not limited to a *drier*, but were broad enough to cover the mechanical devices in all connections. This was a correct ruling. The specification stated that the invention was a drier, or rather an improvement in driers. Consequently the claims should have been so limited, and the

patentee amended by making a “drier” an element in each claim.

Secondly: The words “spring or other catches” were not in the preferred form, and the words “or other” were surplusage. It is a well settled rule of the Patent Office that a claim must not be in the alternative, and such a claim is generally refused.

*Ex parte Holt* (29 O. G., 171).

*Ex parte McDougall* (18 O. G., 130).

*Ex parte Reid* (15 O. G., 882).

*Carr vs. Rice* (1 Fish, 325).

Original Claim 2 being in the alternative in calling for spring *or other* catches, it was proper for the applicant to strike out the words “or other.” While this action left the claim with the word *spring* alone, it did not deprive the applicant of the benefit of equivalents of spring catches. This results from the provision of the statute already cited, which requires an applicant for a patent to describe and claim his invention only in *one form*, viz: the *best form* in which he has contemplated employing it, and then he will be protected in *all forms* which are its equivalents. To repeat the language of Judge Shepley, heretofore quoted from the case of *Murphy vs. Eastman* (5 Fish., 306):

“The patentee does not claim in terms the thing patented, *however its form and proportions may be varied*. But the law so interprets his claim without the addition of those words. In contemplation of law, after he has fully described his invention and shown its principle and claimed it *in a form which perfectly embodies it* unless he disclaims other forms (Note. That was not done in this case—J. H. M.) *he is deemed to claim every form in which his invention may be copied.*”

In the case cited the invention was claimed in an *angular* form, while the infringer had used it in a *circular* form. If the claim had originally been worded as calling for “an *angular or circular* form,” it would have been objectionable, just as Cassidy’s original second claim was. It was not necessary to add the words “or circular,” because the claim already in contemplation of law, covered that form. The words “or circular” were surplusage, they were unnecessary, they were contrary to the rule of the Patent Office prohibiting claims in the alternative. So too of Cassidy’s case. The words “or other” were surplusage, because the word “spring” already covered them.

But whatever effect may be attributed to Cassidy’s course in eliminating the words “or other,” it can go no further than to deprive him of *such other catches as are not equivalents of the springs*. We do not contend that the claim covers *all other*

catches, but only *such others as are the equivalents of the springs*, and the instruction given carefully notes this distinction. It may be that the claim as originally framed was too broad for that reason, in that it attempted to cover *all other* catches, whereas Cassidy's invention included only spring catches or their equivalents.

For instance, the catches shown in the prior patent of Smith consist of the threads of revolving screws (Record 50 *et seq.*) Undoubtedly they are *other catches*, but they are not the equivalents of spring catches, because they operate on a different principle.

The same is true of Alden's drier. His catches are lugs on an endless chain. They too are *other catches*, but are not the equivalents of spring catches, because they likewise work on a different principle and in a different way.

If the claim as originally drawn had been allowed to stand, its language might have been broad enough to include the screw-threads of Smith and lugs of Alden, things not invented by Cassidy and not within the scope of his patent. Therefore, it was eminently proper for him to strike out the broad words "or other" in order to avoid such result. But in so doing he did not intend to deprive himself of *such other catches as were the equivalents of his springs*, nor did the

Patent Office so rule, nor is such the scope of his claim.

This position is rendered unassailable when we remind the Court, *First*: That in the first drier built by Cassidy in April, 1874, and in the first drawing of his invention made about the same time, he used gravity catches, not springs (Record 82-3-4); and *Second*: In the specification of the patent near the close we find the following statement: "Catches which would fall out by gravitation might be substituted for the springs in some cases."

This clause was in the original specification when filed, and was never stricken out. It shows conclusively that the patentee considered spring and gravity catches to be equivalents, that he contemplated using both, that both were in the purview of his invention.

We say, therefore, that gravity catches were just as much a part of Cassidy's invention as spring catches. Gravity catches being the equivalents of spring catches, they being the same thing in a different form, and the claim calling for the best of those two forms (as required by the statute), it is clear that the claim covers both forms.

The cases cited by counsel, on page 16 of their brief, do not militate against these views. They merely decide that where a combination claim, as

originally applied for, is anticipated, and the Patent Office compels the applicant to introduce into the combination another element as a prerequisite to the issuance of a patent, and in order to avoid the anticipation, the patentee cannot afterwards drop that added element and contend that his patent covers a combination which has neither that element nor its equivalent. Such was the case of *Shepard vs. Carrigan* (116 U. S., 593), cited, and the other cases quoted are to the same effect.

It will be seen by the most casual observer that such is a very different proposition from the one under discussion. All we contend for is that our second claim covers spring catches and *such other catches as are their mechanical equivalents*.

We do not contend that it covers *such other catches as are not mechanical equivalents*, that is to say, *all other catches*, which was the thing called for by the original claim and subsequently eliminated. Therefore, it is plain that we are not trying to make our patent include something which was struck out by the Patent Office as not being within the claim.

The precise contention of opposing counsel is that we are not entitled to invoke the doctrine of equivalents at all. They admit in their brief that the gravity catches used by them are the mechanical equivalents of our spring catches. (Brief 17.)

And one of the defendants, while on the stand, went so far as to say: “In my judgment, a spring catch is the mechanical equivalent of a gravity catch. The gravity catches used in my machine are the mechanical equivalents for the spring catches used in the Cassidy machine.” (Record 60.) And yet, in the teeth of such admissions, it is claimed that Cassidy is not entitled to invoke the doctrine at all, because (they assert) all he did himself was to substitute mechanical equivalents for old devices, and that “the same combination with other equivalent elements already existed and he did not invent it.” (Brief 17.)

In this position there are two palpable errors—one an error of fact, the other an error of law. The error of fact is the statement that Cassidy’s combination, with other equivalent elements, already existed. We deny it point blank. It is merely a bold, bald statement, unsupported by any evidence in the Record, and exists only in counsel’s vivid imagination.

Cassidy’s combination, as set forth in his second claim, consists of six elements, viz:

1. A drier.
2. Four stationary posts.
3. A series of spring catches on said posts.
4. Four movable posts arranged to have a vertical reciprocating motion.



5. A series of spring catches thereon.

6. A mechanism for operating the movable posts.

We challenge counsel to point out this combination with other equivalent elements in any device prior to Cassidy's invention. Certainly the Smith does not show it. Its revolving metal screws cannot be called moving posts provided with spring catches, and there is no pretense of four stationary posts provided with spring catches. Nor does that patent show any equivalent combination.

The Alden drier we have already considered and shown to be no equivalent. It has not stationary posts provided with catches, no movable posts provided with catches and having a vertical reciprocating movement.

The Button patent was subsequent to Cassidy's invention and cannot be called a prior device; and besides, it does not show any equivalent combination.

There are no other patents in the Record worthy of note, and we assert that counsel's broad statement quoted *supra* is unsupported by a scintilla of evidence.

The error of law referred to consists in losing sight of the fact that every patentee is entitled to the doctrine of mechanical equivalents in some

form or other. Sometimes he is entitled to the doctrine broadly, as in the case of pioneer or primary inventions; again, he is entitled to it in a more limited and restricted way, as in the case of mere improvements on old devices. But he is always entitled to the doctrine in a greater or less degree. It is merely a question of degree. Counsel's theory would seem to be that only primary inventors are entitled to the doctrine. In this he errs. The doctrine applies to all inventions, whether they be primary or secondary.

This question has been frequently considered by the Courts. Thus, in *Seymour vs. Osborne* (11 Wall., 516), Mr. Justice Clifford said in reference to a patent for an improved combination of old devices:

“ Mere formal alterations in a combination in letters patent, however, are no defense to the charge of infringement, and the withdrawal of one ingredient from the same and the substitution of another, which was well known at the date of the patent as a proper substitute for the one withdrawn, is a mere formal alteration of the combination, if the ingredient substituted performs substantially the same functions as the one withdrawn. *Patentees, therefore, are entitled in all cases to invoke to some extent the doctrine of equivalents. \* \* \** *Bona fide inventors of a combination are as much entitled to suppress every other combination of the same ingredients to produce the same result, not substan-*

tially different from what they have invented and caused to be patented, as any other class of inventors. All alike have the right to suppress every colorable invasion of that which is secured to them by their letters patent, and it is a mistake to suppose that this Court ever intended to lay down any different rule of decision."

Affirming this doctrine in *Gould vs. Rees* (15 Wall., 187), the same learned Justice said:

" Mere formal alterations of a combination in letters patent do not constitute any defense to the charge of infringement, as the inventor of a combination is as much entitled to suppress every other combination of the same ingredients to produce the same result, not substantially different from what he had invented and caused to be patented, as the inventor of any other patented improvement. Such inventors may claim equivalents as well as any other class of inventors, and they have the same right to suppress every other subsequent improvement, not substantially different from what they have invented and secured by letters patent.  
\* \* \* *Bona fide* inventors of a combination are as much entitled to equivalents as the inventors of other patentable improvements; by which is meant that a patentee in such a case may substitute another ingredient for any one of the ingredients of his invention, if the ingredient substituted performs the same function as the one omitted and was well known at the date of his patent as a proper substitute for the one omitted in the patented combination."

And still again in *Gill vs. Wells* (22 Wall., 1), the same Justice says:

“Alterations, however, in combinations which are merely formal, do not constitute a defense to the charge of infringement, as the inventor of a new and useful combination is as much entitled to claim equivalents as any other class of inventors.”

The late Judge Sawyer has occasion to consider this question in *Tatum vs. Gregory* (41 Fed. Rep., 142), which was a suit on a patent for an improvement on old devices, and where the identical question under consideration was raised. He disposed of it by saying:

“The case of *McCormick vs. Talcott* (20 How., 405), was relied on very strongly as limiting this construction. The point covered there relates to the use of mechanical equivalents or substitutes. That case once troubled me a good deal. It was cited in the first patent case that I ever tried, when I was not very familiar with the subject. It was pressed on me very earnestly as holding that the doctrine of mechanical equivalents or substitutes had no application to improvements in patents, or patents for combinations of old elements, and only related to original inventions and new devices. The point was argued and pressed very earnestly. The loose language used in the opinion, perhaps well enough as related to the facts of that case, afforded some ground for such a contention. I myself could not see why the doctrine should not be applicable to combinations and improvements as well as to original patents and new devices. I

rejected that theory. I was afterwards fully sustained in the view that I took in the cases of *Gould vs. Rees*, 15 Wall., 192; *Seymour vs. Osborne*, 11 Wall., 555, and *Gill vs. Wells*, 22 Wall., 28, where the Court stated in very decided terms that the doctrine of equivalents was as applicable to improvements and combinations of old elements, as to original inventions and new devices. The contention of defendants in this case, however stated, really involves that doctrine, whether equivalents in the character of substitutes are available in patents for combinations and improvements. They clearly are, and it is so very distinctly stated in those cases."

Such is the doctrine laid down by the text-writers also.

Says Walker (§ 350):

"The doctrine of equivalents may be invoked by *any* patentee whether he claimed equivalents in his claim, or described any in his specification, or omitted to do either or both of these things."

And so likewise Robinson (Vol. 3, § 258):

"The doctrine of equivalents applies alike to all classes of invention and to all inventions of whatever class."

The true doctrine is one merely of degree. In the case of primary inventions the doctrine is broadly and liberally applied, while in the case of secondary inventions, or mere improvements on old devices, the rule is not so broad or liberal, but only those things are held to be equivalents which

are mere *colorable* evasions of the patented device.

In this connection counsel for plaintiff in error professes to find great similarity between the patent in suit and that involved in *Railroad Co. vs. Mellon* (104 U. S., 112), but the most casual observer will note that the alleged resemblance is purely imaginary.

In that case the invention consisted in a mode of attaching tires to the wheels of locomotives, the essential feature of which was a flange having a *curved or rounded* corner. As originally drawn the specification included a flange with an *angular or square* corner. This claim was twice rejected on the prior patent of Hodge, which showed the *angular* flange. Thereupon the patentee amended his specification by saying:

“ I am aware of the invention described in patent of N. Hodge, November 18, 1851, but I wish it to be understood that I do not claim the invention therein described, viz.: the *angular* flange upon the inner edge of the wheel and the flange upon the outer edge of the wheel, but I do claim as my invention the wheel with the *curved flange* upon the inner edge in combination with a *rounded* corner to fit said *curved* flange, etc.”

This was an express disclaimer of the *angular* flange and a direct limitation of the invention to a *curved one*. Hence the Court held that the invention was limited to the *curved flange*, and did

not cover the *angular* one. The patentee made form the essence of his invention and disclaimed other forms. But in our case the patent is not for a *mere form*. The patentee claims his invention in one form, it is true, but he does not disclaim other forms. Hence he is protected in all forms, because form is not of the essence of his invention. Therefore the instructions referred to in the 37th, 38th and 39th assignments of error were correct, under the decisions of the Court in *Murphy vs. Eastman* (5 Fish., 306), *LeRoy vs. Tatham* (2 Blatch, 486), *Reed vs. Smith* (40 Fed. Rep., 886), *Ives vs. Hamilton* (92 U. S., 426), *Winans vs. Denmead* (15 How., 122), *Brush vs. Condit* (132 U. S., 39), heretofore cited.

*The 40th assignment of error is also bad.*

The instruction against which this assignment is aimed is good law. It reads as follows:

“ If you find that the defendants have used all the specified elements of plaintiff’s second claim, except that they have substituted gravity catches instead of spring catches, and you further find that gravity catches do the same thing in substantially the same way as the spring catches, then the defendants have infringed that claim.”

Of course if we have shown that we are entitled to invoke the doctrine of equivalents, this instruction is correct. It is substantially the language used by the Supreme Court in the *Paper*

*Bag Cases* (97 U. S., 120), and there can be no question of its correctness as a proposition of law.

That the gravity catches are the equivalents of the springs is conceded by counsel and admitted by their clients. We are, therefore, at a loss to conceive any error in the instruction.

## VII.

ALLEGED ERRORS OF THE COURT IN CHARGING THE JURY AS IT DID ON THE QUESTION OF DAMAGES. ASSIGNMENTS OF ERROR 26, 27, 28, 29, 30, 31, 32, 33, 34 and 41.

Before considering these matters specially we here repeat that portion of the Judge's charge which was given on the subject of damages. It reads as follows:

“ Upon the subject of damages I shall give you very few instructions. I shall instruct you that a license fee cannot be allowed as damages in a patent case unless it is proved that a license fee was fixed by the plaintiff, and that he was able to sell rights to others at that price in sufficient quantities to show that the public acquiesced in that price and voluntarily paid it for the right to use the invention. There is no fixed royalty or license fee that can be applied as a rule of damages in this case unless the plaintiff has proven that he was able to sell rights to use the inventions at the price fixed by him. If he did not make sales in such numbers and at such uniform prices as to create an established license fee, then he is not



entitled to claim any such license fee as a rule of damages in this case. If, however, you find from the evidence that plaintiff has established a fixed uniform royalty for the use of his invention by others, and has collected the same from other persons in several instances, then I instruct you that the said royalty is the proper measure of damages.

In all cases the burden of proof is upon the plaintiff to show the amount of his damages. The damages must be proved by competent reliable evidence. They must not be guessed at or conjectured."

This last paragraph was given at the instance of plaintiff in error. It will be found at page 121 of Record. The remainder of the charge quoted will be found at pages 117 and 118.

We claim that these portions of the charge taken together are full, complete and correct expositions of the law on the subject, so much so that at the close of their brief counsel for plaintiff in error are compelled to say: "To the general fairness of the charge we pay our tribute of respect." If so, there was no error in refusing to give the instructions now complained of. But nevertheless, we shall consider them *seriatim*.

*The 26th assignment of error.* The instruction there asked was very properly refused. We never contended that the plaintiff was entitled to "recover as damages *the profits that he made by mak-*

*ing and selling the driers as an entire machine,"* and the jury did not award any such damages. That question was not in the case at all, and however correct it may be as an abstract question of law, it was entirely irrelevant to any issue involved. The entire profits usually made by Cassidy on his machines were \$125 each. The number of infringing driers made and used by defendants was 18. Hence, Cassidy's entire profits on 18 driers would have been \$2,250. We never claimed that amount of damages at any time during the trial. We claimed a royalty or license fee of \$100 for each drier. The jury awarded us only \$1,350 or \$75 per drier, which was neither the full royalty nor the full profits. Hence, the instruction was not pertinent to any issue in the case. It was simply an abstract proposition of law, and as such was properly refused.

*The 27th assignment of error.* This was properly refused for two reasons. In the first place it undertook to instruct the jury on a question of fact by telling them point blank that the plaintiff was not entitled to recover any license fee as damages. *But that was purely a question of fact for the jury to pass on* and it would have been error for the Judge to take it away from them and pass on it himself.

In the next place, it undertakes to make a dis-

inction between the amount of a license fee under a patent in the State of California and elsewhere. Such is not the law. In the absence of evidence to the contrary, a license fee is a license fee throughout the entire United States. Uniformity is its prime requisite. Says Mr. Walker (Walk. Pats., § 557):

“A defendant may successfully object to a given royalty \* \* \* \* unless it was uniform,” and such is the general law on the subject.

It may be true that a patentee may under special circumstances fix different royalties for different States, but in such case there must be some evidence of such course. In this case there is no evidence that a different royalty was fixed for different States; and in the absence of such evidence it must be presumed that the royalty was uniform throughout the United States; but there is no evidence of such course in this case, and in the absence thereof it must be presumed that the royalty was uniform throughout all localities. Had it been otherwise, it was the duty of defendant to show it.

*The 28th assignment of error.* Even if the instruction here asked correctly states the law on the subject and the refusal to give it was error, still it was in no way prejudicial to plaintiff in error, because the jury did not award us the full

license fee. The full license fee was \$100 per drier. The jury awarded damages at the rate of \$75 per drier. Evidently they considered that \$75 was a fair proportion of the license fee for the one claim infringed. Hence we do not see how the plaintiff in error was prejudiced by the refusal to give the instruction. If error it be, it was a harmless one, one not affecting the verdict in any way whatever; and if it had been given, it would not have altered the verdict.

“ To render an exception available in this Court, it must affirmatively appear that the ruling excepted to affected, or might have affected the decision of the case.”

*Florida R. R. Co. vs. Smith* (21 Wall., 255).

In the language of Mr. Justice Blatchford:

“ No judgment should be reversed in a Court of error when it is clear that the error could not have prejudiced, and did not prejudice, the rights of the party against whom the ruling was made.”

*Lancaster vs. Collins* (115 U. S., 227), and cases cited.

*West vs. Camden* (135 U. S., 521).

*The 29th assignment of error.* The same answer applies to this as was given to the 28th.

In addition thereto the instruction is liable to further objections. It tells the jury that the mere

sale of licenses, while the patent had a certain number of years to run, “ does not *of itself* prove ” that the patentee could have made subsequent sales at the same amount when the patent had a less number of years to run. But there was more evidence on the subject than the *mere fact* stated above. Consequently, it would have been error to give the instruction, because it was an abstract question of law not called for by the facts of the case. Such instructions are never proper and it is no error to refuse them.

*The 30th assignment of error.* There was no error in refusing to give this instruction because it had already been substantially given.

The instruction which was refused amounted simply to saying that the plaintiff must prove his damages by reliable testimony, or else can recover only nominal damages. This proposition of law had already been given to the jury in slightly different language.

The Court had already said:

“ In all cases the burden of proof is upon the plaintiff to show the amount of his damages. The damages must be proved by competent reliable evidence. They must not be guessed at or conjectured.” (See Record 121, near bottom.)

And in connection with this the Court had also said to the jury:

“ If you do not find any royalty the plaintiff would be entitled only to nominal damages. (See Record 121, bottom.)

*The 31st and 32d assignments of error.* These instructions are each a mere statement of an abstract proposition of law not relevant to the issues of the case, and as such were properly refused.

They were copied bodily from the decision of Mr. Justice Field in *Garretson vs. Clark*, where he was discussing certain abstract propositions of law. We do not deny their correctness, but they are not applicable to the issues here involved. There was no occasion for them. The “defendant’s profits” were not issue. The instructions, we repeat, were simply abstract propositions of law not pertinent to the case.

*The 33d and 34th assignments of error.* These instructions were palpably bad, because they undertook to take away from the jury questions of fact which were proper to be passed on by the jury, and the jury alone. It was virtually taking the entire case from them. Hence, the instructions were properly refused.

*The 41st assignment of error.* This is aimed at an instruction which was given by the Court at the instance of defendant in error. It reads as follows:

“ If, however, you find from the evidence that

plaintiff has established a fixed uniform royalty for the use of his invention by others, and has collected the same from other persons in several instances, then I instruct you that the said royalty is the proper measure of damages.”

The objection raised to this instruction is aimed at the words “in several instances”; but this complies with the law. It is settled that a *single instance* of a royalty collected is not sufficient evidence of an established royalty, but that a plurality of instances is.

“Proof of a *single license* was given in this case, but it cannot, in view of the circumstances, be regarded as affording the only measure of compensation to which the plaintiff is entitled” (*Judson vs. Bradford*, 3 Ban. and Ard., 549—Clifford).

“The market value of the patent in question could not be established by the *single license* referred to” (*Vulcanite Co. vs. American Co.*, 36 Fed. Rep., 379—Butler).

“Proof of a *single license* is not enough” (*Graham vs. Plano Mfg. Co.*, 35 Fed. Rep., 598—Blodgett).

“The sale of a single license is not sufficient to establish a royalty” (Walker).

“A single license cannot show a custom” (Robinson).

But on the other hand a plurality of instances (several), will be sufficient for the purpose.

“ It is a general rule in patent causes that established license fees are the best measure of damages that can be used \* \* \* As to the sufficiency of the proof, we see no occasion to disturb the conclusion reached by the master on this point. The complainant proved *several instances* of licenses given by him to large sewing machine companies, the fees on which were regularly paid, and corresponded with the rate allowed by the master. We think that the defendant has no occasion to complain of the amount awarded ” (*Clark vs. Wooster*, 119 U. S., 322—Bradley).

In view of these authorities the instruction was correct.

But even if there should be a technical or verbal error in the instruction when standing alone, yet taken in connection with the rest of the general charge on the subject of damages, it is not erroneous and could not have prejudiced defendant's case. The Court said:

“ \* \* \* A license fee cannot be allowed as damages in a patent case unless it is proved that a license fee was fixed by the plaintiff, and that he was able to sell rights to others at that price in sufficient quantities to show that the public acquiesced in that price and voluntarily paid it for the right to use the invention. There is no fixed royalty or license fee that can be applied, as a rule of damages in this case, unless the plaintiff has proven that he was able to sell rights to use the invention at the price fixed by him. If he did not make sales in such numbers and at such uniform



prices as to create an established license fee, then he is not entitled to claim any such license fee as a rule of damages." (Record 117.)

Then followed the instruction now under consideration. Taking the whole charge on this subject together, we insist that there was no error.

The rule on this subject was stated by Mr. Justice Story, at a very early day, to be as follows:

"The whole scope and hearing of a charge must be taken together. It is wholly inadmissible to take up detached passages and to decide upon them without attending to the context, or without incorporating such qualifications and explanations as naturally flow from the language of other parts of the charge. The whole is to be construed as it must have been understood both by the Court and jury at the time it was delivered."

*Magniac vs. Thomson*, 7 Pet., 346.

And to the same effect are

*Carver vs. Astor* (4 Pet., 80).

*Spring vs. Eagar* (99 U. S., 659).

*Castle vs. Bullard* (23 How., 172).

In conclusion we submit that the trial had in this case was in every respect fair and impartial and no error of law is made to appear in the Record. The charge of the Court is without a flaw. Indeed, it was so plainly and strikingly fair to both parties, that even the technical counsel for plaintiff in error are compelled to say in their

brief: "To the general fairness of the charge we pay our tribute of respect."

The damages awarded are certainly not excessive. They are less than what we claimed and are less than the usual rate of royalty charged and collected by the patentee from others. No motion for a new trial was made, so that the Court could have had an opportunity to reduce them, if they were too large, and we submit that this Court should not disturb the verdict.

Respectfully submitted.

JOHN H. MILLER,

J. P. LANGHORNE,

For Defendant in Error.

















